

NATUCER

NATUCER
CERÁMICA NATURAL

NATUCER

NATUCER, S.L. - C/ Les Forques, 2 - 12200 Onda (Castellón) Spain - Apdo. nº 6
Tel.: + [34] 964 60 40 66 [8 líneas] - Fax: + [34] 964 77 16 10 - www.natucer.es
[Dpto. Cont. y Admon.]: natucer@natucer.es - Fax: + [34] 964 77 16 10
[Dpto. Comercial Nac.]: nacional@natucer.es - Fax: + [34] 964 60 24 25
[Dpto. Comercial Exp.]: comercial@natucer.es - Fax: + [34] 964 77 16 10
[Dpto. Técnico y Lab.]: laboratorio@natucer.es



COLLECTION 2019 | 20

COLLECTION
2019 | 20

30TH ANNIVERSARY NATUCER



100% MADE IN SPAIN = 100% GARANTIA DE CALIDAD

100% MADE IN SPAIN = 100% QUALITY GUARANTEE

EVOLUTION
EXTRUDED PORCELAIN TILE

PORCELÁNICO
PORCELAIN TILE

inklinker
NEW TECH

ek ecoklinker

www.natucer.es

STEP 120

25mm
ESPESOR
THICKNESS



PELDAÑO ANGULAR
120 x 32/2,5
60 x 32/2,5

PELDAÑO CURVO
120 x 32/2,5
60 x 32/2,5

PELDAÑO ANGULAR
120 x 32/3
60 x 32/3

ZÓCALO
9,8 x 120
9,8 x 60
9 x 36
9 x 30
9 x 25
9 x 22,5
7,5 x 80
7,5 x 60

ÁNGULO PELDAÑO CURVO 2PZ
33 x 46/4

ÁNGULO PELDAÑO CURVO 4PZ
33 x 33

REMATE PELDAÑO CURVO
IZQ. / DRCH.
2,5 x 32

REMATE PELDAÑO ANGULAR
IZQ. / DRCH.
2,5 x 32

PELDAÑO CURVO
36 x 33/4
30 x 33/4
25 x 33/4
22,5 x 33/4

ZANQUÍN
9 x 36
9 x 30
9 x 25

ZANQUÍN 2,5
9 x 36
9 x 30

PASAMANOS
18 x 30/4
18 x 25/4
15 x 25/4
15 x 30/4

ZÓCALO ANGULAR
9,5 x 30 x 4

ESQUINA EXTERIOR
ZÓCALO ANGULAR
9,5 x 4

ESQUINA INTERIOR
ZÓCALO ANGULAR
9,5 x 4



BORDE DE PISCINA
30 x 36/4



DESBORDANTE
30 x 30/2,2



GRATING
19 x 30/2,2
18 x 36/2



REJILLA
12,5 x 30/2,2
12,5 x 60/2,2

- PROBLEMAS + SOLUCIONES

- PROBLEMS + SOLUTIONS

Natucer cuenta con una gran variedad de piezas especiales que no sólo garantizan un acabado perfecto, sino que también permiten resolver estéticamente aspectos arquitectónicos como bordes de piscina o escaleras. Piezas diseñadas para lograr soluciones específicas para pavimentos exigentes. Natucer ofrece un pavimento ideal para emplazamientos arquitectónicos exteriores y zonas húmedas que precisen de exigentes prestaciones frente al deslizamiento. Pensado y fabricado para garantizar la máxima seguridad.

NATUCER has a great variety of special pieces that not only guarantee a perfect finish, but also enables giving aesthetically ideas to architectural aspects such as edges of pool or stairs. Pieces designed to achieve specific solutions for specific floors. NATUCER offers an ideal floor for humid areas and exterior architectural sites that require demanding benefits from sliding. Designed and manufactured to guarantee maximum safety.

VIERTE AGUAS
15 x 36/4
15 x 30/4
15 x 25/4
15 x 22,5/4

ÁNGULO PELDAÑO CURVO 1PZ
33 x 33/4

PELDAÑO ANGULAR
30 x 32/4
32 x 32/4

ÁNGULO PELDAÑO ANGULAR 2PZ
32 x 46/4

Piensa en formas

PIENSA EN NATUCER

THINK IN FORMS, THINK IN NATUCER

NATUCER explora la geometría a través de sus diferentes formatos. Hexágonos y piezas irregulares que pasan a convivir con las formas tradicionales. Piezas con mucho valor añadido ideales para propuestas de decoración que buscan la pureza de las líneas.

NATUCER explores the geometry through different formats. Hexagons and irregular pieces that live together with traditional forms. Pieces with added value ideal for decoration proposals seeking the purity of the lines.

Diferentes formas

Different forms

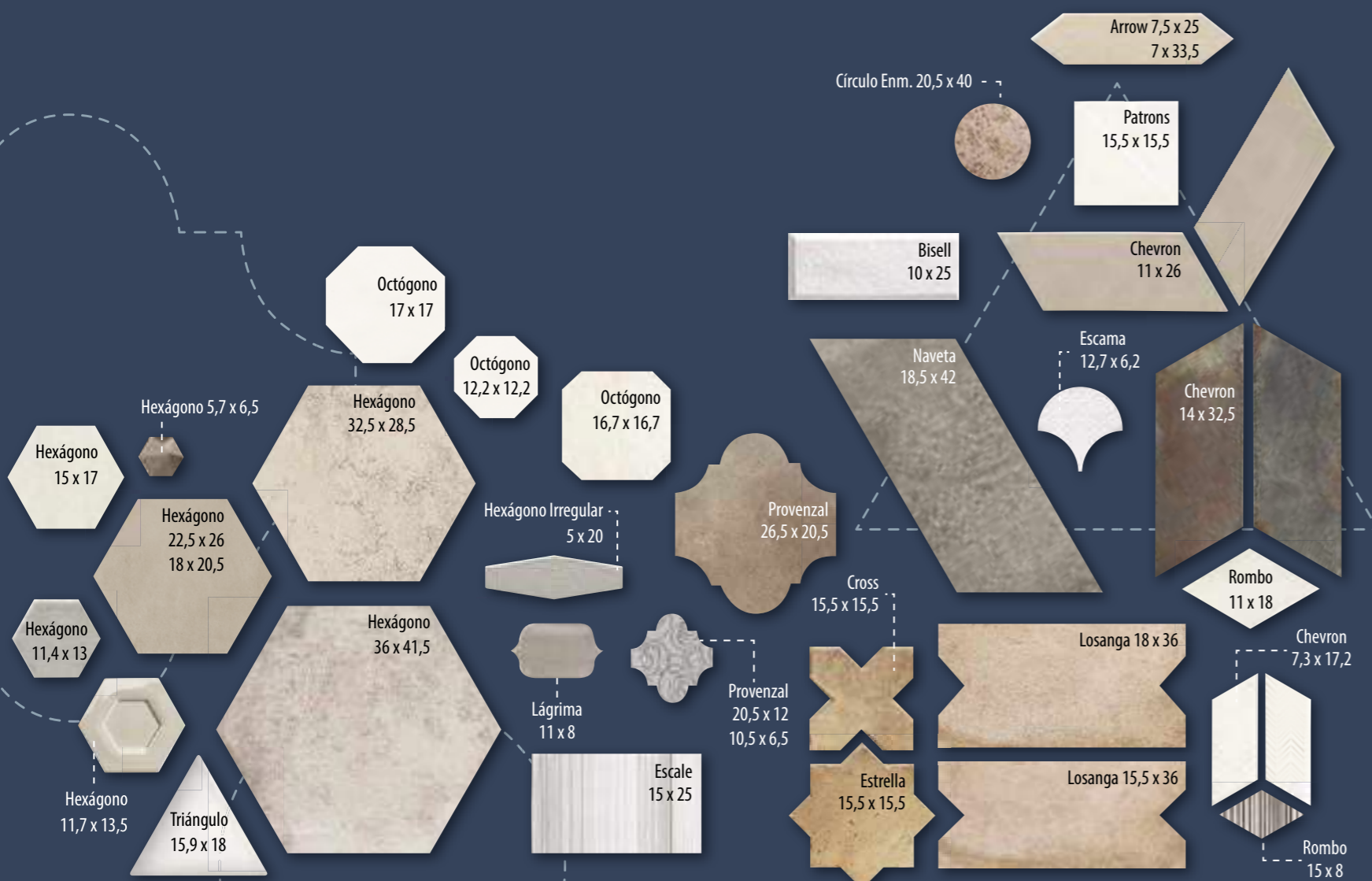

Piezas modulares

Modular pieces

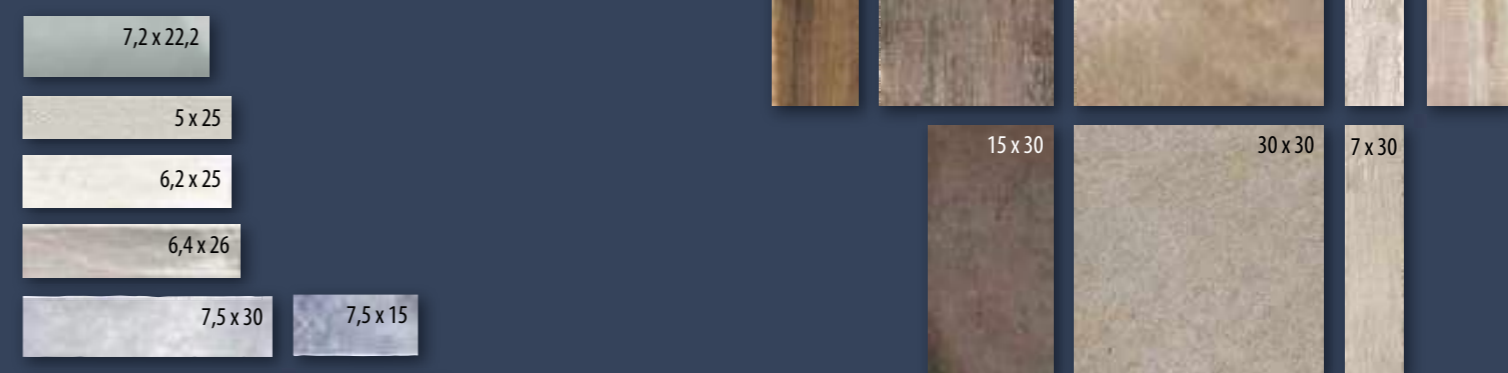

Múltiples formatos

Multiple formats





SEGURA

Estos productos no deslizan, son resistentes a las heladas, dificultan la adherencia de las manchas y ofrecen alta resistencia a golpes fuertes.

SAFE

These products are non-slip, frost and stain resistant and are also highly resistant to heavy blows.



FÁCIL LIMPIEZA Y MANTENIMIENTO

La cerámica se caracteriza por su alta facilidad de limpieza y su capacidad de preservación frente a la suciedad y cualquier tipo de contaminación.

EASY CLEANING AND MAINTENANCE

Ceramic tiles are easy to clean and are highly resistant to dirt and all types of contamination.

In addition, the fact that ceramic is an electrical insulator means that the tiles repel electrically active atmospheric dust, thereby contributing to a more pleasant environment.

HIGIÉNICA Y ANTIALERGÉNICA

La naturaleza inerte y el carácter impermeable de la cerámica permite prevenir la humedad, evitando el desarrollo de colonias de gérmenes y hongos.

HYGIENIC AND ANTI-ALLERGENIC

The inert and impermeable nature of ceramic tiles helps to prevent damp from forming, a factor which contributes to the development of colonies of germs and fungi.

ESTÉTICA Y VERSÁTIL

La cerámica es versátil y adaptable a cualquier superficie.

Las diferentes posibilidades de colocación, sus texturas y volúmenes permiten diseñar libremente los espacios obteniendo resultado espectaculares.

ESTHETIC AND VERSATILE

Ceramic tiles are highly versatile and can be adapted to any surface. The various layout patterns, textures and volumes allow for a countless range of options and truly spectacular results.



DURADERA Y RESISTENTE

Su resistencia a los cambios bruscos de temperatura, a la humedad, a los agentes químicos y biológicos, así como su dureza y resistencia al rozamiento avalan su gran durabilidad en las edificaciones.

DURABLE AND RESISTANT

Ceramic tiles offer optimum levels of durability in buildings, thanks to their resistance to sudden temperature changes, damp and chemical and biological agents, as well as their hardness and scratch resistance.



IGNÍFUGA

Es un material inerte e incombustible, creado a partir de arcilla. La cerámica no se quema: es uno de los pocos materiales que, incluso en contacto directo con las llamas, no se quema, derrite, ni libera ninguna sustancia.

FIREPROOF

It is an inert, fireproof material made from sand and clay. Ceramic is one of the few materials that does not burn or release substances of any kind even when it comes into contact with a naked flame.

RESPONSABLE Y SOSTENIBLE

Es un material resistente al paso del tiempo, por lo que puede llegar a alcanzar ciclos de vida muy sostenibles. La industria está apostando por la investigación sobre reciclabilidad del material. El uso de cerámica en fachadas (fachadas ventiladas) y cubiertas consigue importantes ahorros energéticos.

RESPONSIBLE AND SUSTAINABLE

They are highly resistant to wear and tear, and can therefore reach highly sustainable and lengthy life cycles. The industry is currently researching the recycling options this material offers. Furthermore, the use of ceramic tiles on façades (ventilated façades) and roofs guarantees major energy savings.

EFICIENCIA ENERGÉTICA

La masa térmica inherente de los azulejos reduce el calentamiento y enfriamiento máximos, lo que ayuda a moderar los cambios de temperatura en los hogares.

ENERGY EFFICIENCY

The thermal mass inherent in the tiles, reduce the heating and cooling that help to moderate the change temperature in our house.

TRADICIÓN Y NATURAL

Las piezas cerámicas sólo utilizan tres elementos básicos del medio ambiente: la tierra o la arcilla, el agua y el fuego.

TRADITION AND NATURE

Only three of nature's basic elements are used in the production of ceramic tiles: earth (clay), water and fire.



USO DEL CATÁLOGO // USE OF CATALOGUE

COLOR DE TIPOLOGÍA

- PAVIMENTO
Pavement
- REVESTIMIENTO
Coating

SIMBOLOGÍA

- Porcelánico
Porcelain tile
- Gres extrusionado porcelánico
Porcelain extruded tile
- Pavimento de interior
Indoor floor tile
- Pavimento Exterior
Outdoor floor tile
- Revestimiento
Wall tile
- Destonificado Armonioso
Controlled destonification
- Sin Mantenimiento
No maintenance
- Resistencia al rayado
Scratch resistance
- Resistente al desgaste
Wear resistance
- Resistente a la helada
Frost proof
- Resistencia a ácidos y bases
Resistance to acids and bases
- Superficie mate
Matt surface
- Superficie satinado
Glossy surface
- Superficie brillo
Surface brightness / shine
- Superficie semibrillo
Surface semi-gloss
- Modularidad
Modularity
- Rectificado
Rectified
- Diseños Diferentes
Different Designs
- Enmallado
On a mesh
- Antideslizante
Antislip
- Pintado a mano
Hand painted
- Enmallado pintado a mano
Hand painted on a mesh
- Volumen
Volume
- Bajo relieve
Under relief
- Tercer fuego
Third fire
- Barro
Quarry
- Producto envejecido
Old looking product
- Cola de milano - dovetail
Seguridad de agarre - Grip safety
- Bordes y Superficie Irregular
Irregular Edges and Surface

AMBIENTES DE LA SERIE

COLORES

FORMATOS DISPONIBLES

36 x 41,5
TAMAÑO EN CENTÍMETROS
Size centimeters

(G 58)
CÓDIGO DE PRECIO
Price code

14" x 16,2"
TAMAÑO EN PULGADAS
Size inches

NOMBRE DE LA SERIE

PALAZZO

TIPOLOGÍA DE FABRICACIÓN



CARACTERÍSTICAS TÉCNICAS



COLORES - COLORS



FORMATO	PORCELÁNICO	RECTIFICADO	MT	CANALLET	PERFORADO	PERFORADO
36x41,5	11,8	11,8	11,8	11,8	11,8	11,8
36x41,5	11,8	11,8	11,8	11,8	11,8	11,8

FORMATO	PORCELÁNICO	RECTIFICADO	MT	CANALLET	PERFORADO	PERFORADO
36x41,5	11,8	11,8	11,8	11,8	11,8	11,8
36x41,5	11,8	11,8	11,8	11,8	11,8	11,8



PIEZAS ESPECIALES - SPECIAL PIECES

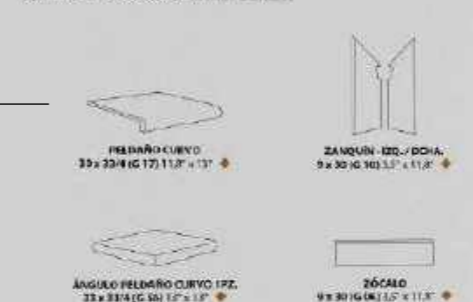

DECORACIÓN - DECORATION



PACKING LIST

PIEZAS ESPECIALES

DECORACIÓN

TIPOLOGÍA DE FABRICACIÓN

- fine RESISTANCE** ACABADO ESPECIAL PAVIMENTO EXTERIOR
Is the finished special one for pavements of exterior
- Comfort floor** ACABADO ESPECIAL PAVIMENTO INTERIOR
Is the finished special one for pavements of interior
- in & out** DOS ACABADOS, MISMA SENSACIÓN ESTÉTICA
Two finishes same aesthetic feeling
- inkKlinker** IMPRESIÓN DIGITAL PARA EXTRUSIÓN
Digital printing for Extrusion
- AntiSlip** ANTIDESLIZANTE
Antislip
- ANTIBACTERIANO** Antibacterial
- Pasta Blanca** PASTA BLANCA
White body
- EVOLUTION** PORCELÁNICO EXTRUIDO
Extruded porcelain tile
- PORCELÁNICO** Porcelain tile
- PRODUCTO SE VENDE POR M2**
This product is sold per sqm
- PRODUCTO SE VENDE POR PIEZA**
This product is sold per piece
- HECHO A MANO**
Hand made

CARACTERÍSTICAS TÉCNICAS

- FUERZA DE ROTURA** Breaking strength
- CARGA DE ROTURA** Breaking
- RESISTE EL DESGASTE** Wear resistance
- RESISTE EL RAYADO** Surface hardness
- ANTD.TORUS**
- MANCHAS** Staining
- DILATACIÓN** Dilatation
- RESISTE LA FLEXIÓN** Bending resistance
- ABSORCIÓN** Water absorption
- ANTIDESLIZANTE** Antislip

NÚMERO DE PÁGINA

PARK

IN & OUTDOOR
RECTIFIED

PORCELÁNICO
PORCELAIN TILE



CLASE I - R9
UNE-EN12667:2003
DIN 51130:2004
Comfort floor
CENTRAL PARK - STANLEY PARK - RETIRO PARK - HYDE PARK

fine RESISTANCE
CLASE III - R11
UNE-EN12667:2003
DIN 51130:2004
CENTRAL PARK ANTIDES. - HYDE PARK ANTIDES.

FORMATO
20 x 120 - 8" x 48"

- PORCELÁNICO PORCELAIN TILE
- RECT RECTIFICADO RECTIFIED
- DESTONIF. ARMONIOSO CONTROLLED DESTONIF.
- DISEÑOS DIFERENTES DIFFERENT DESIGNS
- RESIST. A LA HELADA FROST PROOF
- RESIST. A ÁCIDOS Y BASES RESIST. TO ACIDS & BASES
- SUPERFICIE MATE MATT SURFACE
- SIN MANTENIMIENTO NO MAINTENANCE



COLORES · COLORS



CENTRAL PARK
20 x 120 (G 68) 8" x 48" m²
CENTRAL PARK ANTISLIP
20 x 120 (G 70) 8" x 48" m²



STANLEY PARK
20 x 120 (G 68) 8" x 48" m²



HYDE PARK
20 x 120 (G 68) 8" x 48" m²
HYDE PARK ANTISLIP
20 x 120 (G 70) 8" x 48" m²



RETIRO PARK
20 x 120 (G 68) 8" x 48" m²

ENMALLADOS · ON A MESH

Disponible en todos los colores · Available in all colors

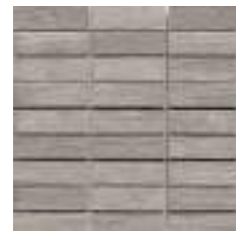

FRONTAL MOSAICO TIRA PARK
15 x 30 (G 16) 5,9" x 11,8" ◆ ◆
CENTRO MOSAICO TIRA PARK
30 x 30 (G 18) 11,8" x 11,8" ◆ ◆

Disponible también en MIX HYDE/RETIRO · Available in MIX HYDE/RETIRO



FRONTAL MOSAICO TACO PARK
MIX CENTRAL/STANLEY
15 x 30 (G 16) 5,9" x 11,8" ◆ ◆
CENTRO MOSAICO TACO PARK
MIX CENTRAL/STANLEY
30 x 30 (G 18) 11,8" x 11,8" ◆ ◆

Disponible en todos los colores · Available in all colors



FRONTAL MOSAICO TACO PARK
15 x 30 (G 16) 5,9" x 11,8" ◆ ◆
CENTRO MOSAICO TACO PARK
30 x 30 (G 18) 11,8" x 11,8" ◆ ◆

Disponible también en MIX CENTRAL/STANLEY · Available in MIX CENTRAL/STANLEY



FRONTAL MOSAICO TIRA PARK
MIX HYDE/RETIRO
15 x 30 (G 16) 5,9" x 11,8" ◆ ◆
CENTRO MOSAICO TIRA PARK
MIX HYDE/RETIRO
30 x 30 (G 18) 11,8" x 11,8" ◆ ◆

PIEZAS ESPECIALES · SPECIAL PIECES

Disponible en todos los colores · Available in all colors



Disponible en CENTRAL PARK ANTISLIP y HYDE PARK ANTISLIP
Available in CENTRAL PARK ANTISLIP & HYDE PARK ANTISLIP

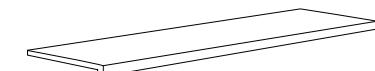

PELDAÑO ANGULAR
120 x 32/3 (G 72) 48" x 12,5" x 1" ◆ ◆
60 x 32/3 (G 73) 23,6" x 12,5" x 1" ◆ ◆

Consultar disponibilidad
Check availability

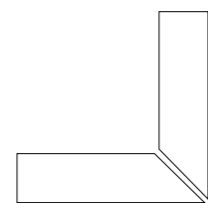

ÁNGULO PELDAÑO 120. INT
120 x 32 x 45/3 (G 46 x 2)
48" x 12,6" x 17,7" / 1" ◆ ◆

Consultar disponibilidad
Check availability

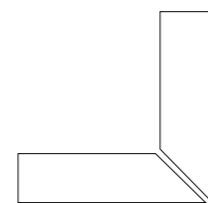

ÁNGULO PELDAÑO 120. EXT
120 x 32 x 45/3 (G 46 x 2)
48" x 12,6" x 17,7" / 1" ◆ ◆

Consultar disponibilidad
Check availability

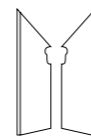

ZANQUÍN - IZQ. / DRCH.
9,8 x 30 (G 12) 3,9" x 11,8" ◆ ◆

REMATE PELDAÑO
ANGULAR - IZQ. / DRCH.
3 x 32 (G 15) 1" x 12,5" ◆ ◆

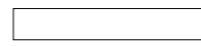

FRONTAL
15 x 120 (G 74) 6" x 8" ◆ ◆

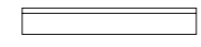

ZÓCALO
9,8 x 120 (G 74) 3,9" x 48" ◆ ◆
9,8 x 60 (G 75) 3,9" x 23,6" ◆ ◆

Comfort floor ▶ R9 - Class I

PACKING BASES

FORMATO	PULGADAS	PZ/CAJA	M ²	CAJA/PLT	PESO/CAJA	PESO/PLT
20 x 120	8" x 48"	4	0,96	48	22,5	1.095
ENM. FRONTAL 15 x 30	5,9" x 11,8"	15	0,68	60	14,95	912
ENM. CENTRO 30 x 30	11,8" x 11,8"	11	1	72	21,85	1.590

PACKING PIEZAS ESPECIALES

FORMATO	PULGADAS	PZ/CAJA	ML	CAJA/PLT	PESO/CAJA	PESO/PLT
FRONTAL 15 x 120	6" x 48"	4	4,8	48	16,9	826
ZÓCALO 9,8 x 120	3,9" x 48"	8	9,6	63	22	1400
ZÓCALO 9,8 x 60	3,9" x 23,6"	16	9,6	72	21,9	1591
PELDAÑO ANG. 120 x 32/3	48" x 12,5"/1"	2	2,4	14	36,7	530
ANG. PELDAÑO 120 INT. 120 x 32 x 45	48" x 12,5" x 17,7"	2	2,4	14	32	450
ANG. PELDAÑO 120 EXT. 120 x 32 x 45	48" x 12,5" x 17,7"	2	2,4	14	32	450
PELDAÑO ANG. 60 x 32/3	23,6" x 12,5"/1"	2	1,2	28	18,9	542
ZANQUÍN 9,8 x 30	3,9" x 11,8"	30	9	48	16,24	794
REMATE PELDAÑO 3 x 32	1" x 12,5"	20	6,4	60	3,5	219

TECH·PARK

fine **RESISTANCE**



14 mm
ESPESOR

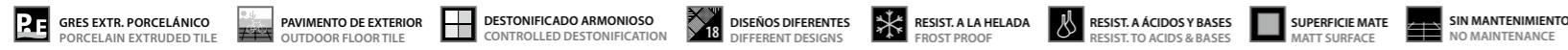

COLORES · COLORS

fine **RESISTANCE** ▶ R11 - Class III



TECH CENTRAL PARK ANTISLIP
11 x 22,5 (G 39) 4,3" x 8,8" **ml**



TECH HYDE PARK ANTISLIP
11 x 22,5 (G 39) 4,3" x 8,8" **ml**



TECH CENTRAL PARK ANTISLIP
30 x 90 (G 58) 11,8" x 35,4" **ml**



TECH HYDE PARK ANTISLIP
30 x 90 (G 58) 11,8" x 35,4" **ml**



TECH RETIRO PARK ANTISLIP
11 x 22,5 (G 39) 4,3" x 8,8" **ml**



TECH STANLEY PARK ANTISLIP
30 x 90 (G 58) 11,8" x 35,4" **ml**



TECH RETIRO PARK ANTISLIP
30 x 90 (G 58) 11,8" x 35,4" **ml**

APLICACIONES · APPLICATIONS



PIEZAS ESPECIALES · SPECIAL PIECES

Disponible en STANLEY · Available in STANLEY

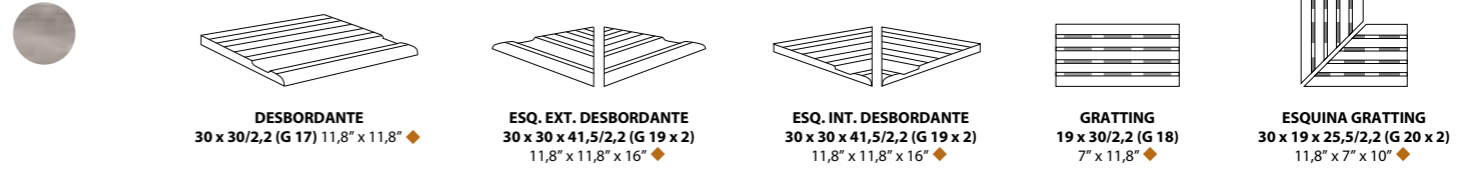

PIEZAS ESPECIALES · SPECIAL PIECES

Disponible en STANLEY y RETIRO · Available in STANLEY & RETIRO

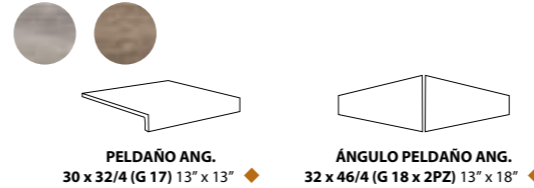

PIEZAS ESPECIALES · SPECIAL PIECES

Disponible en CENTRAL y HYDE · Available in CENTRAL & HYDE

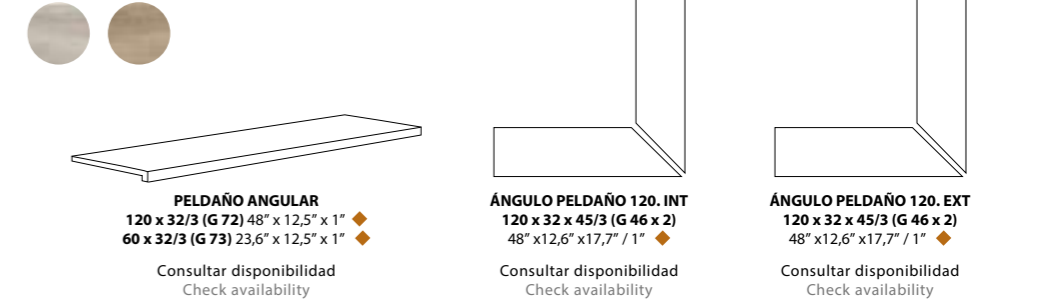

PIEZAS ESPECIALES · SPECIAL PIECES

Disponible en todos los colores · Available in all colors

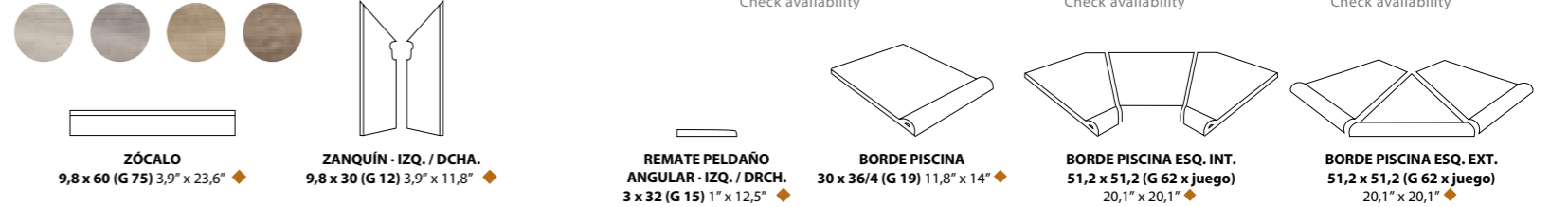

PACKING BASES

FORMATO	PULGADAS	PZ/CAJA	M ²	CAJA/PLT	PESO/CAJA	PESO/PLT
11 x 22,5	4,3" x 8,8"	20	0,5	112	13,70	1550
30 x 90	11,8" x 35,4"	3	0,81	40	23,5	955
ENM. FRONTAL 15 x 30	5,9" x 11,8"	15	0,68	60	14,95	912
ENM. CENTRO 30 x 30	11,8" x 11,8"	11	1	72	18,36	1.336

PACKING PIEZAS ESPECIALES

FORMATO	PULGADAS	PZ/CAJA	ML	CAJA/PLT	PESO/CAJA	PESO/PLT
ZÓCALO 9,8 x 30	3,9" x 11,8"	30	9	48	19,6	955
ZANQUÍN 9,8 x 30	3,9" x 11,8"	30	9	48	16,24	794
PELD. ANG. 30 x 32/4	11,8" x 13"	4	1,2	54	9,9	550
ANG. PELDAÑO ANG. 32 x 46/4	13" x 18"	2	0,32	90	3,2	300

PACKING PIEZAS ESPECIALES

FORMATO	PULGADAS	PZ/CAJA	ML	CAJA/PLT	PESO/CAJA	PESO/PLT
GRATTING 19 x 30/2,2	7" x 11,8"	6	3,3	56	15	850
ESQ. GRATTING 30 x 19 x 25,5/2,2	11,8" x 7" x 10"	6	3,3	56	11,4	640
DESbordante 30 x 30/2,2	11,8" x 11,8"	6	1,8	44	17,75	796
ESQ. EXT. DESbordante 30 x 30 x 41,5/2,2	11,8" x 11,8" x 16"	2	0,6	90	6,3	578
ESQ. INT. DESbordante 30 x 30 x 41,5/2,2	11,8" x 11,8" x 16"	2	0,6	90	6,3	578
PELDAÑO ANG. 120 x 32/3	48" x 12,5" / 1"	2	2,4	14	36,7	530
PELDAÑO ANG. 60 x 32/3	23,6" x 12,5" / 1"	2	1,2	28	18,9	542
REMATO PELDAÑO 3 x 32	1" x 12,5"	20	6,4	60	3,5	219
ANG. PELDAÑO 120 INT. 120 x 32 x 45	48" x 12,5" x 17,7"	2	2,4	14	32	450
ANG. PELDAÑO 120 EXT. 120 x 32 x 45	48" x 12,5" x 17,7"	2	2,4	14	32	450
BORDE PISCINA 30 x 36/4	11,8" x 14"	3	0,90	44	15,7	691
B. PISC. ESQ. INT. 51,2 x 51,2	20,1" x 20,1"	1	0,51	18	12,71	245
B. PISC. ESQ. EXT. 51,2 x 51,2	20,1" x 20,1"	1	0,51	18	12,71	245

PARK OUTDOOR

fineRESISTANCE

EVOLUTION
EXTRUDED PORCELAIN TILE

CLASE III - R11
UNE-EN 12633:2003
DIN 51130:2004

ANTI-BACTERIAL

FORMATO

21 x 60 - 8" x 23,6"

GRES EXTR. PORCELÁNICO / PORCELAIN EXTRUDED TILE
PAVIMENTO DE EXTERIOR / OUTDOOR FLOOR TILE
DESTONIFICADO ARMONIOSO / CONTROLLED DESTONIFICATION
DISEÑOS DIFERENTES / DIFFERENT DESIGNS
RESIST. A LA HELADA / FROST PROOF
RESIST. A ÁCIDOS Y BASES / RESIST. TO ACIDS & BASES
SUPERFICIE MATE / MATT SURFACE
SIN MANTENIMIENTO / NO MAINTENANCE



COLORES · COLORS

fineRESISTANCE ▶ R11 - Class III



CENTRAL PARK ANTISLIP
21 x 60 (G 68) 8" x 23,6" m



HYDE PARK ANTISLIP
21 x 60 (G 68) 8" x 23,6" m



STANLEY PARK ANTISLIP
21 x 60 (G 68) 8" x 23,6" m



RETIRO PARK ANTISLIP
21 x 60 (G 68) 8" x 23,6" m

ENMALLADOS · ON A MESH

Disponibles en todos los colores
Available in all colors



FRONTAL MOSAICO TIRA PARK
15 x 30 (G 16) 5,9" x 11,8" m

Disponibles también en MIX HYDE/RETIRO
Available in MIX HYDE/RETIRO



FRONTAL MOSAICO TACO PARK
MIX CENTRAL/STANLEY
15 x 30 (G 16) 5,9" x 11,8" m

Disponibles en todos los colores
Available in all colors



FRONTAL MOSAICO TACO PARK
15 x 30 (G 16) 5,9" x 11,8" m

Disponibles también en MIX CENTRAL/STANLEY
Available in MIX CENTRAL/STANLEY

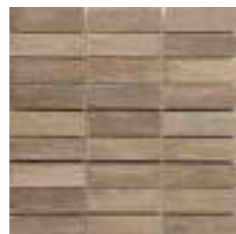

FRONTAL MOSAICO TIRA PARK
MIX HYDE/RETIRO
15 x 30 (G 16) 5,9" x 11,8" m



PIEZAS ESPECIALES · SPECIAL PIECES

Disponibles en STANLEY · Available in STANLEY

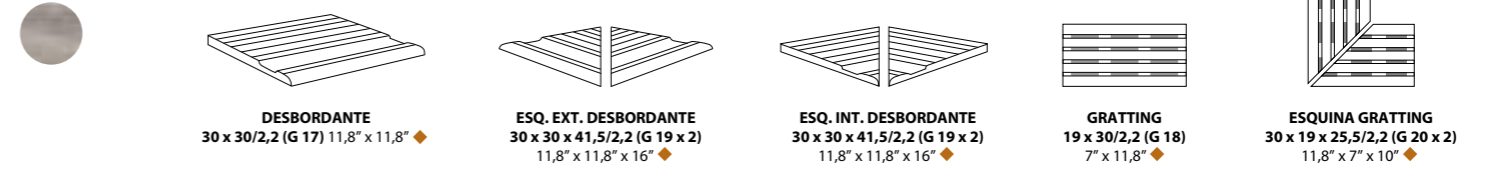

PIEZAS ESPECIALES · SPECIAL PIECES

Disponibles en STANLEY y RETIRO · Available in STANLEY & RETIRO

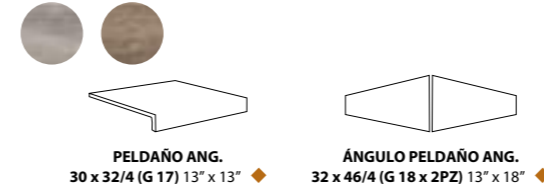

PIEZAS ESPECIALES · SPECIAL PIECES

Disponibles en CENTRAL y HYDE · Available in CENTRAL & HYDE

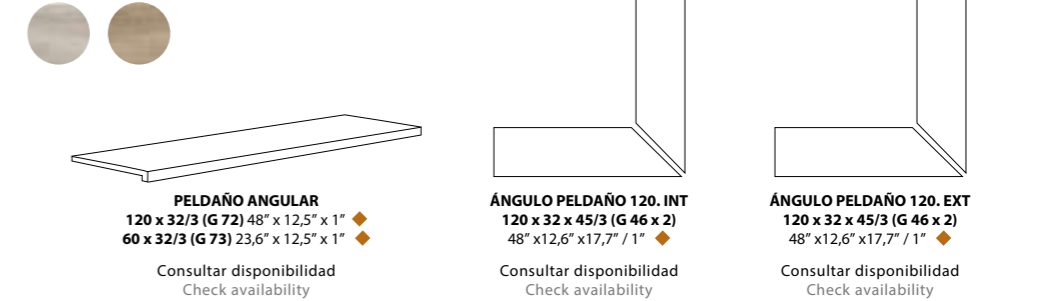

PIEZAS ESPECIALES · SPECIAL PIECES

Disponibles en todos los colores · Available in all colors

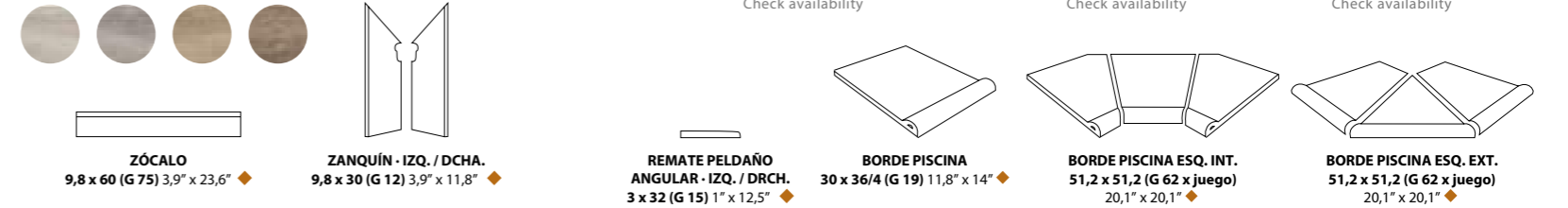

PACKING BASES

FORMATO	PULGADAS	PZ/CAJA	M ²	CAJA/PLT	PESO/CAJA	PESO/PLT
21 x 60	8" x 23,6"	8	1	72	23,17	1682
ENM. FRONTAL 15 x 30	5,9" x 11,8"	15	0,68	60	14,95	912
ENM. CENTRO 30 x 30	11,8" x 11,8"	11	1	72	18,36	1.336

PACKING PIEZAS ESPECIALES

FORMATO	PULGADAS	PZ/CAJA	ML	CAJA/PLT	PESO/CAJA	PESO/PLT
ZÓCALO 9,8 x 30	3,9" x 11,8"	30	9	48	19,6	955
ZANQUÍN 9,8 x 30	3,9" x 11,8"	30	9	48	16,24	794
PELD. ANG. 30 x 32/4	11,8" x 13"	4	1,2	54	9,9	550
ANG. PELDAÑO ANG. 32 x 46/4	13" x 18"	2	0,32	90	3,2	300

PACKING PIEZAS ESPECIALES

FORMATO	PULGADAS	PZ/CAJA	ML	CAJA/PLT	PESO/CAJA	PESO/PLT
GRATING 19 x 30/2,2	7" x 11,8"	6	3,3	56	15	850
ESQ. GRATING 30 x 19 x 25,5/2,2	11,8" x 7" x 10"	6	3,3	56	11,4	640
DESBORDANTE 30 x 30/2,2	11,8" x 11,8"	6	1,8	44	17,75	796
ESQ. EXT. DESBORDANTE 30 x 30 x 41,5/2,2	11,8" x 11,8" x 16"	2	0,6	90	6,3	578
ESQ. INT. DESBORDANTE 30 x 30 x 41,5/2,2	11,8" x 11,8" x 16"	2	0,6	90	6,3	578
PELD. ANG. 120 x 32/3	48" x 12,5"/1"	2	2,4	14	36,7	530
PELD. ANG. 60 x 32/3	23,6" x 12,5"/1"	2	1,2	28	18,9	542
REMATE PELDAÑO 3 x 32	1" x 12,5"	20	6,4	60	3,5	219
ANG. PELDAÑO 120 INT. 120 x 32 x 45	48" x 12,5" x 17,7"	2	2,4	14	32	450
ANG. PELDAÑO 120 EXT. 120 x 32 x 45	48" x 12,5" x 17,7"	2	2,4	14	32	450
BORDE PISCINA 30 x 36/4	11,8" x 14"	3	0,90	44	15,7	691
B. PISC. ESQ. INT. 51,2 x 51,2	20,1" x 20,1"	1	0,51	18	12,71	245
B. PISC. ESQ. EXT. 51,2 x 51,2	20,1" x 20,1"	1	0,51	18	12,71	245

TECH·RAIL



14 mm
ESPOSOR

GRES EXTRUSIONADO PORCELÁNICO / PORCELAIN EXTRUDED TILE | PAVIMENTO DE EXTERIOR / OUTDOOR FLOOR TILE | SUPERFICIE MATE / SURFACE MATT | RESISTENCIA A ÁCIDOS Y BASES / RESISTANCE TO ACIDS AND BASES | RESISTENCIA A LA HELADA / FROST PROOF | DESTONIFICADO ARMONIOSO / CONTROLLED DESTONIFICATION | SIN MANTENIMIENTO / NO MAINTENANCE



TECH RAIL ASPEN



TECH RAIL WILLOW

COLORES · COLORS

14 mm
ESPOSOR



TECH RAIL ASPEN
21 x 60 (G 58) 8" x 23,6" m²



TECH RAIL NUT
21 x 60 (G 58) 8" x 23,6" m²



TECH RAIL WILLOW
21 x 60 (G 58) 8" x 23,6" m²



TECH RAIL CHERRY
21 x 60 (G 58) 8" x 23,6" m²



TECH RAIL TEAK
21 x 60 (G 58) 8" x 23,6" m²

APLICACIONES · APPLICATIONS



PIEZAS ESPECIALES · SPECIAL PIECES

Disponible en todos los colores · Available in all colors

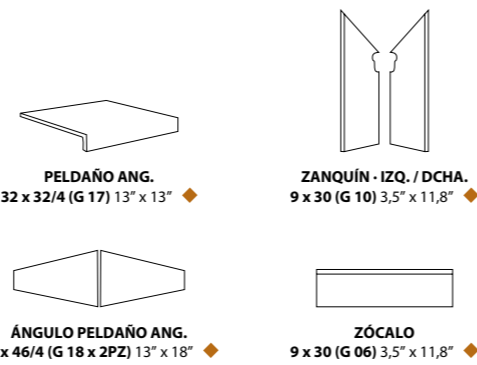

TECH RAIL NUT

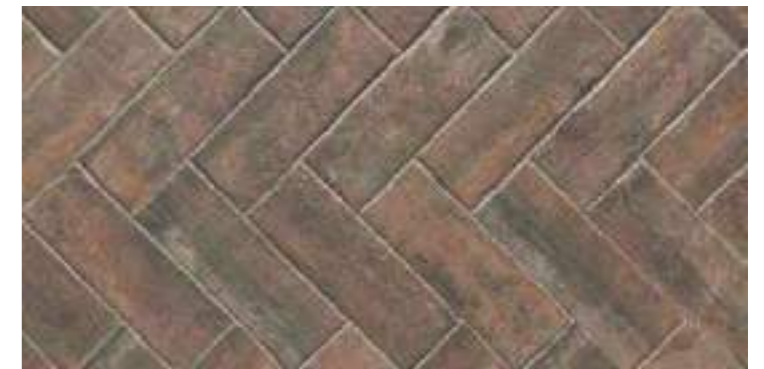

TECH RAIL CHERRY

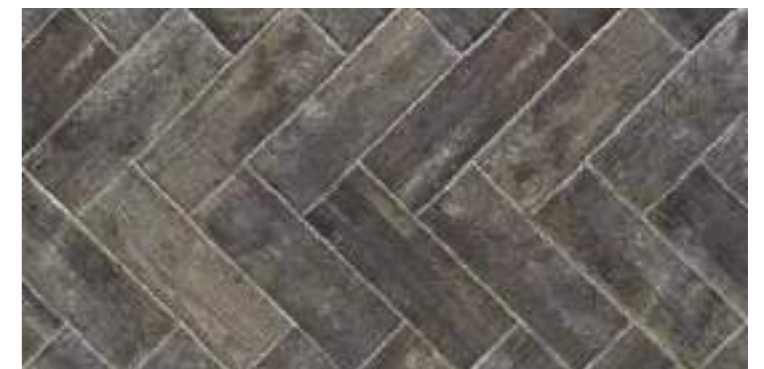

TECH RAIL TEAK

PACKING BASES

FORMATO	PULGADAS	PZ/CAJA	M²	CAJA/PLT	PESO/CAJA	PESO/PLT
21 x 60	8" x 23,6"	6	0,75	72	22,55	1,638

PACKING PIEZAS ESPECIALES

FORMATO	PULGADAS	PZ/CAJA	ML	CAJA/PLT	PESO/CAJA	PESO/PLT
PELDAÑO ANG. 32 x 32/4	13" x 13"	4	1,28	54	11,55	640
ANG. PELDAÑO ANG. 32 x 44/4	13" x 18"	2	0,32	90	3,2	300
ZÓCALO 9 x 30	3,5" x 11,8"	30	9	48	19,60	955
ZANQUÍN 9 x 30	3,5" x 11,8"	30	9	48	16,24	794

RETRO



fine RESISTANCE
R11 - Class III



RESISTE LA FLEXIÓN
29,1 N/mm2



RESISTE EL DESGASTE
PEI (II - IV)



RESISTE EL RAYADO
MOHS - 8



ANTIDESLIZANTE
Class III - R11



MANCHAS
Class 5 - Class A



ABSORCIÓN
0,3%



DILATACIÓN
6,4° 10°/°C

FORMATO

21 x 60 - 8" x 23,6"
7 x 60 - 3" x 23,6"
36 x 41,5 - 14" x 16,2"
18,5 x 42 - 7" x 16,4"

GRES EXTRUSIONADO PORCELÁNICO
 PAVIMENTO DE EXTERIOR
 SUPERFICIE MATE
 RESISTENCIA A ÁCIDOS Y BASES
 RESISTENCIA A LA HELADA
 DESTONIFICADO ARMONIOSO
 SIN MANTENIMIENTO



RETRO BLANC



RETRO TERRA

COLORES · COLORS

fine RESISTANCE ▶ R11 - Class III



RETRO BLANC NAVETA
18,5 x 42 (G 39) 7" x 16,4" m²



RETRO TERRA NAVETA
18,5 x 42 (G 39) 7" x 16,4" m²



RETRO CENDRA NAVETA
18,5 x 42 (G 39) 7" x 16,4" m²



RETRO NEGRE NAVETA
18,5 x 42 (G 39) 7" x 16,4" m²



RETRO BLANC HEX.
36 x 41,5 (G 58) 14" x 16,2" m²



RETRO TERRA HEX.
36 x 41,5 (G 58) 14" x 16,2" m²



RETRO CENDRA HEX.
36 x 41,5 (G 58) 14" x 16,2" m²



RETRO NEGRE HEX.
36 x 41,5 (G 58) 14" x 16,2" m²



RETRO BLANC
21 x 60 (G 38) 8" x 23,6" m²
7 x 60 (G 27) 3" x 23,6" m²



RETRO TERRA
21 x 60 (G 38) 8" x 23,6" m²
7 x 60 (G 27) 3" x 23,6" m²



RETRO CENDRA
21 x 60 (G 38) 8" x 23,6" m²
7 x 60 (G 27) 3" x 23,6" m²



RETRO NEGRE
21 x 60 (G 38) 8" x 23,6" m²
7 x 60 (G 27) 3" x 23,6" m²



RETRO CENDRA



RETRO NEGRE

PACKING BASES

FORMATO	PULGADAS	PZ/CAJA	M ²	CAJA/PLT	PESO/CAJA	PESO/PLT
21 x 60	8" x 23,6"	8	1	72	23,17	1,682
7 x 60	3" x 23,6"	24	1	66	22,25	1,483
HEX. 36 x 41,5	14" x 16,2"	9	1	48	22,6	1,103
NAVETA 18,2 x 42	7" x 16,4"	13	1,01	64	19,93	1,289

PACKING PIEZAS ESPECIALES

FORMATO	PULGADAS	PZ/CAJA	ML	CAJA/PLT	PESO/CAJA	PESO/PLT
PELDAÑO ANG. 32 x 32/4	13" x 13"	4	1,28	54	11,55	640
ANG. PELDAÑO ANG. 32 x 46/4	13" x 18"	2	0,32	90	3,16	308
ZÓCALO 9 x 30	3,5" x 11,8"	30	9	48	19,60	955
ZANQUÍN 9 x 30	3,5" x 11,8"	30	9	48	16,24	794

PIEZAS ESPECIALES · SPECIAL PIECES

Disponibile in todos los colores · Available in all colors

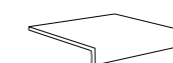

PELDAÑO ANG.
32 x 32/4 (G 17) 13" x 13" ◆



ÁNGULO PELDAÑO ANG.
32 x 46/4 (G 18 x 2PZ) 13" x 18" ◆



ZÓCALO
9 x 30 (G 06) 3,5" x 11,8" ◆

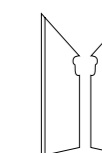

ZANQUÍN - IZQ. / DCHA.
9 x 30 (G 10) 3,5" x 11,8" ◆



LEGNO ANTIQUO BRINDISI



LEGNO ANTIQUO VITERBO

COLORES - COLORS

fine RESISTANCE ▶ R12 - Class III



LEGNO ANTIQUO BRINDISI
6,5 x 25 (G 39) 2,5" x 10" m²



LEGNO ANTIQUO VITERBO
6,5 x 25 (G 39) 2,5" x 10" m²



LEGNO ANTIQUO TIVOLI
6,5 x 25 (G 39) 2,5" x 10" m²



TRAB. ENM. BRINDISI
25 x 50 (G 60) 10" x 20" m²



TRAB. ENM. VITERBO
25 x 50 (G 60) 10" x 20" m²



TRAB. ENM. TIVOLI
25 x 50 (G 60) 10" x 20" m²



LEGNO ANTIQUO BRINDISI
21 x 60 (G 38) 8" x 23,6" m²
10,5 x 60 (G 39) 4" x 23,6" m²



LEGNO ANTIQUO VITERBO
21 x 60 (G 38) 8" x 23,6" m²
10,5 x 60 (G 39) 4" x 23,6" m²



LEGNO ANTIQUO TIVOLI
21 x 60 (G 38) 8" x 23,6" m²
10,5 x 60 (G 39) 4" x 23,6" m²



LEGNO ANTIQUO ANCONA
21 x 60 (G 38) 8" x 23,6" m²
10,5 x 60 (G 39) 4" x 23,6" m²



LEGNO ANTIQUO TAPPETO BRINDISI
21 x 60 (G 27) 8" x 23,6" m²



LEGNO ANTIQUO TAPPETO VITERBO
21 x 60 (G 27) 8" x 23,6" m²



LEGNO ANTIQUO TAPPETO TIVOLI
21 x 60 (G 27) 8" x 23,6" m²



LEGNO ANTIQUO TAPPETO ANCONA
21 x 60 (G 27) 8" x 23,6" m²

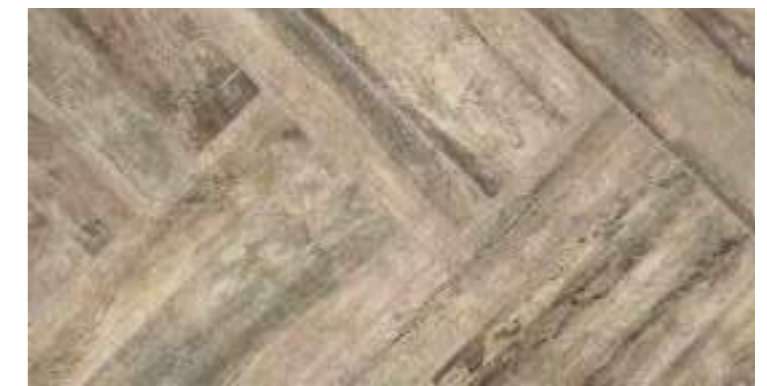

LEGNO ANTIQUO TIVOLI

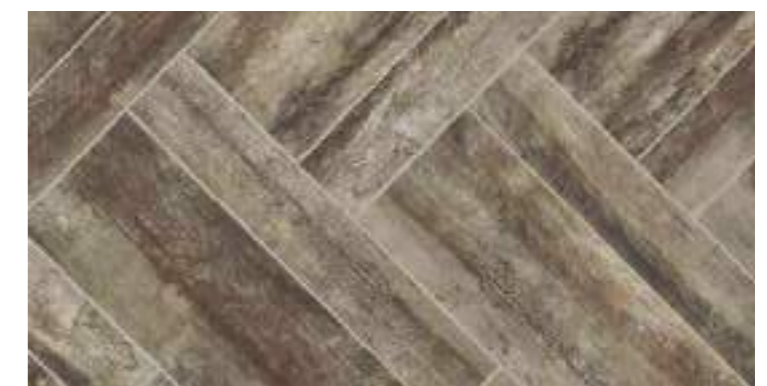

LEGNO ANTIQUO ANCONA

PACKING BASES

FORMATO	PULGADAS	PZ/CAJA	M ²	CAJA/PLT	PESO/CAJA	PESO/PLT
21 x 60	8" x 23,6"	8	1	72	23,17	1,682
10,5 x 60	4" x 23,6"	16	1	72	20,58	1,496
6,5 x 25	2,5" x 10"	27	0,439	176	9,31	1,657
TRAB. ENM. 25 x 50	10" x 20"	6	0,75	56	14,1	805

PACKING PIEZAS ESPECIALES

FORMATO	PULGADAS	PZ/CAJA	ML	CAJA/PLT	PESO/CAJA	PESO/PLT
PELDAÑO ANG. 32 x 32/4	13" x 13"	4	1,28	54	11,55	640
ANG. PELDAÑO ANG. 32 x 46/4	13" x 18"	2	0,32	90	3,16	308
ZÓCALO 9 x 30	3,5" x 11,8"	30	9	48	19,6	955
ZANQUÍN 9 x 30	3,5" x 11,8"	30	9	48	16,24	794

PIEZAS ESPECIALES - SPECIAL PIECES

Disponibile in todos los colores - Available in all colors

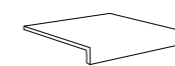

PELDAÑO ANG.
32 x 32/4 (G 17) 13" x 13" ◆

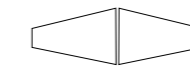

ÁNGULO PELDAÑO ANG.
32 x 46/4 (G 18 x 2PZ) 13" x 18" ◆

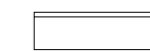

ZÓCALO
9 x 30 (G 06) 3,5" x 11,8" ◆

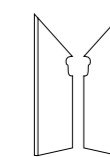

ZANQUÍN - IZQ. / DCHA.
9 x 30 (G 10) 3,5" x 11,8" ◆



FORMATO
21 x 60 - 8" x 23,6"
10,5 x 60 - 4" x 23,6"

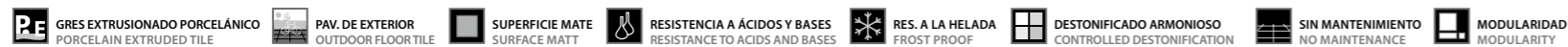

COLORES · COLORS



RIOJA HARO
21 x 60 (G 56) 8" x 23,6"
10,5 x 60 (G 27) 4" x 23,6"



RIOJA LAGUARDIA
21 x 60 (G 56) 8" x 23,6"
10,5 x 60 (G 27) 4" x 23,6"



FRONTAL WOOD
15,5 x 30 (G 12) 6" x 11,8"



RIOJA LOGROÑO
21 x 60 (G 56) 8" x 23,6"
10,5 x 60 (G 27) 4" x 23,6"



RIOJA BRIONES
21 x 60 (G 56) 8" x 23,6"
10,5 x 60 (G 27) 4" x 23,6"



RIOJA NAJERA
21 x 60 (G 56) 8" x 23,6"
10,5 x 60 (G 27) 4" x 23,6"



RIOJA ABALOS
21 x 60 (G 56) 8" x 23,6"
10,5 x 60 (G 27) 4" x 23,6"

DECORACIÓN · DECORATION

PIEZAS ESPECIALES · SPECIAL PIECES

Disponible en todos los colores · Available in all colors

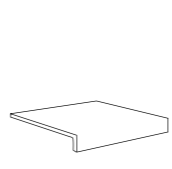

PELDAÑO ANG.
32 x 32/4 (G 17) 13" x 13"

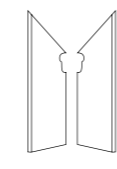

ZANQUÍN · IZQ. / DCHA.
9 x 30 (G 10) 3,5" x 11,8"

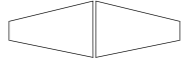

ÁNGULO PELDAÑO ANG.
32 x 46/4 (G 18 x 2PZ) 13" x 18"

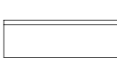

ZÓCALO
9 x 30 (G 06) 3,5" x 11,8"

PIEZAS ESPECIALES · SPECIAL PIECES

Disponible en HARO, LAGUARDIA y ABALOS
Available in HARO, LAGUARDIA & ABALOS



PELDAÑO ANGULAR
120 x 32/2,5 (G 42) 48" x 12,5"/1"
60 x 32/2,5 (G 57) 23,6" x 12,5"/1"

REMATE PELDAÑO ANGULAR · IZQ. / DRCH.
2,5 x 32 (G 15) 1" x 12,5"

COLORES DISPONIBLES:
Remate Peldaño Angular CAVA combinable con HARO
Remate Peldaño Angular MALTA combinable con ABALOS y LAGUARDIA

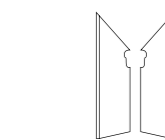

ZANQUÍN 2,5 A · IZQ. / DRCH.
9 x 30 (G 11) 3,5" x 11,8"

Disponible en HARO, LAGUARDIA y ABALOS
Available in HARO, LAGUARDIA & ABALOS



BORDE PISCINA ESQUINA INT. RIOJA
51,2 x 51,2 (G 62 x juego) 20,1" x 20,1"



BORDE PISCINA ESQUINA EXT. RIOJA
51,2 x 51,2 (G 62 x juego) 20,1" x 20,1"



BORDE PISCINA RIOJA
30 x 36/4 (G 19)
11,8" x 14"

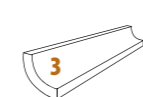

MEDIA CAÑA INT.
4 x 30 x 4 (G 12) 1,5" x 11,8" x 1,5"



CUBRECANTO
4 x 30 x 4 (G 13) 1,5" x 11,8" x 1,5"



COMP. INTERIOR MEDIA CAÑA
4 x 4 (G 17) 1,5" x 1,5"



COMP. INTERIOR CUBRECANTO
4 x 4 (G 17) 1,5" x 1,5"



COMP. EXTERIOR CUBRECANTO
4 x 4 (G 17) 1,5" x 1,5"



COMP. EXTERIOR MEDIA CAÑA
4 x 4 (G 17) 1,5" x 1,5"

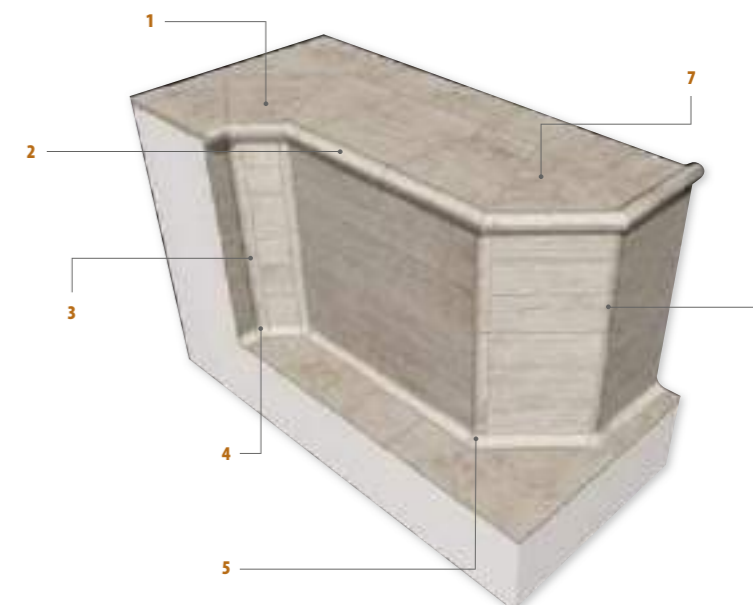

PACKING BASES

FORMATO	PULGADAS	PZ/CAJA	M ²	CAJA/PLT	PESO/CAJA	PESO/PLT
21 x 60	8" x 23,6"	8	1	72	23,17	1.682
10,5 x 60	4" x 23,6"	16	1	72	20,58	1.496

PACKING DECORADO

FORMATO	PULGADAS	PZ/CAJA	ML	CAJA/PLT	PESO/CAJA	PESO/PLT
15,5 x 30	6" x 11,8"	15	4,5	56	14,9	850

PACKING PIEZAS ESPECIALES

FORMATO	PULGADAS	PZ/CAJA	ML	CAJA/PLT	PESO/CAJA	PESO/PLT
PELDAÑO ANG. 32 x 32/4	13" x 13"	4	1,28	54	11,55	640
ZÓCALO 9 x 30	3,5" x 11,8"	30	9	48	19,6	955
ZANQUÍN 9 x 30	3,5" x 11,8"	30	9	48	16,24	794
ANG. PELD. ANG. 32 x 46/4	13" x 18"	2	0,32	90	3,20	308

PACKING PIEZAS ESPECIALES

FORMATO	PULGADAS	PZ/CAJA	ML	CAJA/PLT	PESO/CAJA	PESO/PLT
BORDE PISCINA 30 x 36/4	11,8" x 14"	3	0,9	44	15,7	691
B. PISC. ESQ. EXT. 51,2 x 51,2	20,1" x 20,1"	1	0,51	18	12,71	245
B. PISC. ESQ. INT. 51,2 x 51,2	20,1" x 20,1"	1	0,51	18	12,71	245
MEDIA CAÑA INT. 4 x 30 x 4	1,5" x 11,8" x 1,5"	22	6,6	-	9,91	-
COMP. EXT. MEDIA CAÑA 4 x 4	1,5" x 1,5"	20	0,6	-	1,34	-
COMP. INT. MEDIA CAÑA 4 x 4	1,5" x 1,5"	20	0,66	-	1,84	-

PACKING PIEZAS ESPECIALES

FORMATO	PULGADAS	PZ/CAJA	ML	CAJA/PLT	PESO/CAJA	PESO/PLT
CUBRECANTO 4 x 30 x 4	1,5" x 11,8" x 1,5"	26	7,8	-	7,33	-
COMP. EXT. CUBRECANTO 4 x 4	1,5" x 1,5"	25	0,83	-	0,55	-
COMP. INT. CUBRECANTO 4 x 4	1,5" x 1,5"	10	0,33	-	0,85	-
PELDAÑO ANG. 120 x 32/2,5	48" x 12,5"/1"	2	2,4	14	36,7	530
PELDAÑO ANG. 60 x 32/2,5	23,6" x 12,5"/1"	2	1,2	28	18,9	542
ZANQUÍN 2,5 A 9 x 30	3,5" x 11,8"	30	9	48	16,24	794
REMATE PELDAÑO 2,5 x 32	1" x 12,5"	20	6,4	60	3,5	219

Tucson

PORCELÁNICO
PORCELAIN TILE

ANTI-BACTERIAL

Comfort floor

CLASE I - R9
UNE-EN 12633:2003
DIN 51130:2004

fine RESISTANCE

CLASE III - R11
UNE-EN 12633:2003
DIN 51130:2004

PORCELÁNICO
PORCELAIN TILE

RECTIFICADO
RECTIFIED

RESIST. A LA HELADA
FROST PROOF

MOSH - 5 - CLASE I
MOSH - 6 - CLASE III

DESTONIF. ARMONIOSO
CONTROLLED DESTONIF.

RESIST. A ÁCIDOS Y BASES
RESIST. TO ACIDS & BASES

PEI (III - IV) - CLASE I
PEI (V) - CLASE III

SUPERFICIE MATE
MATT SURFACE

SIN MANTENIMIENTO
NO MAINTENANCE

FORMATO
80 x 80 - 31,5" x 31,5"



COLORES · COLORS



TUCSON WHITE
80 x 80 (G 69) 31,5" x 31,5"

TUCSON WHITE ANTISLIP
80 x 80 (G 71) 31,5" x 31,5"



TUCSON NATURAL
80 x 80 (G 69) 31,5" x 31,5"



TUCSON GREY
80 x 80 (G 69) 31,5" x 31,5"

TUCSON GREY ANTISLIP
80 x 80 (G 71) 31,5" x 31,5"



TUCSON IRON
80 x 80 (G 69) 31,5" x 31,5"

PACKING BASES

FORMATO	PULGADAS	PZ/CAJA	M ²	CAJA/PLT	PESO/CAJA	PESO/PLT
80 x 80	31,5" x 31,5"	2	1,28	40	29	1.180

PACKING PIEZAS ESPECIALES

FORMATO	PULGADAS	PZ/CAJA	ML	CAJA/PLT	PESO/CAJA	PESO/PLT
PELDAÑO ANG. 120 x 32/3	48" x 12,5"/1"	2	2,4	14	36,7	530
ANG. PELDAÑO 120 INT. 120 x 32 x 45	48" x 12,5" x 17,7"	2	2,4	14	32	450
ANG. PELDAÑO 120 EXT. 120 x 32 x 45	48" x 12,5" x 17,7"	2	2,4	14	32	450
PELDAÑO ANG. 60 x 32/3	23,6" x 12,5"/1"	2	1,2	28	18,9	542
REMATE PELDAÑO 3 x 32	1" x 12,5"	20	6,4	60	3,5	219
ZANQUÍN 7,5 x 30	3" x 11,8"	30	9	48	16,24	794
ZÓCALO 7,5 x 80	3" x 31,5"	20	16	60	25	1.515
ZÓCALO 7,5 x 60	3" x 23,6"	24	14,4	66	22,9	1.526

PIEZAS ESPECIALES · SPECIAL PIECES

Disponible en todos los colores
Available in all colors



Disponible en WHITE y GREY
Available in WHITE & GREY



PELDAÑO ANGULAR
120 x 32/3 (G 72) 48" x 12,5" x 1"

Consultar disponibilidad
Check availability

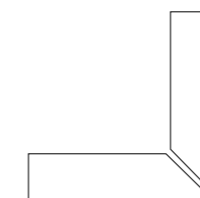

ÁNGULO PELDAÑO 120. INT
120 x 32 x 45/3 (G 46 x 2)
48" x 12,6" x 17,7" / 1"

Consultar disponibilidad
Check availability

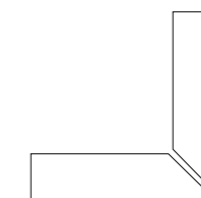

ÁNGULO PELDAÑO 120. EXT
120 x 32 x 45/3 (G 46 x 2)
48" x 12,6" x 17,7" / 1"

Consultar disponibilidad
Check availability



PELDAÑO ANG.
60 x 32/3 (G 73) 23,6" x 12,6"

Consultar disponibilidad
Check availability



ZÓCALO
7,5 x 80 (G 15) 3" x 31,5"
7,5 x 60 (G 74) 3" x 23,6"

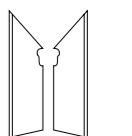

ZANQUÍN - IZQ. / DRCH.
7,5 x 30 (G 12) 3" x 11,8"

Consultar disponibilidad
Check availability

Comfort floor ▶ R9 - Class I

fine RESISTANCE ▶ R11 - Class III

TECH·TUCSON

fine **RESISTANCE**

EVOLUTION
EXTRUDED PORCELAIN TILE
CLASE III - R 11
UNE EN 12633-2003
DIN 51130-2004
ANTI-BACTERIAL

- RESISTE LA FLEXIÓN 32 N/m2
- RESISTE EL DESGASTE PEI (III - IV)
- RESISTE EL RAYADO MOHS- 8-9
- ANTIDESLIZANTE Class I - R9
- MANCHAS Class 5 - Class A
- ABSORCIÓN <0,3%
- DILATACIÓN 5,7° 10° / °C

14 mm
ESPESOR

- GRES EXTRUSIONADO PORCELÁNICO / PORCELAIN EXTRUDED TILE
- PAVIMENTO DE EXTERIOR / OUTDOOR FLOOR TILE
- SUPERFICIE MATE / SURFACE MATT
- RESISTENCIA A ÁCIDOS Y BASES / RESISTANCE TO ACIDS AND BASES
- RESISTENCIA A LA HELADA / FROST PROOF
- DESTONIFICADO ARMONIOSO / CONTROLLED DESTONIFICATION
- SIN MANTENIMIENTO / NO MAINTENANCE



COLORES · COLORS

14 mm
ESPESOR



TECH TUCSON WHITE ANTISLIP
30 x 90 (G 58) 11,8" x 35,4" m²



TECH TUCSON GREY ANTISLIP
30 x 90 (G 58) 11,8" x 35,4" m²



TECH TUCSON NATURAL ANTISLIP
30 x 90 (G 58) 11,8" x 35,4" m²



TECH TUCSON IRON ANTISLIP
30 x 90 (G 58) 11,8" x 35,4" m²

COLORES · COLORS



TUCSON WHITE ANTISLIP
30 x 60 (G 69) 11,8" x 23,6" m²



TUCSON GREY ANTISLIP
30 x 60 (G 69) 11,8" x 23,6" m²



TUCSON NATURAL ANTISLIP
30 x 60 (G 69) 11,8" x 23,6" m²



TUCSON IRON ANTISLIP
30 x 60 (G 69) 11,8" x 23,6" m²

APLICACIONES · APPLICATIONS

- ZONAS RESIDENCIALES / RESIDENTIAL AREAS
- PASEOS URBANOS / URBAN AREAS
- TERRAZAS Y PATIOS / TERRACE & PATIOS
- ZONAS COMERCIALES / COMMERCIAL AREAS
- PISCINAS / SWIMMING POOLS
- JARDINES / GARDENS
- ZONAS TRANSITABLES / HIGH TRAFFIC AREAS



PIEZAS ESPECIALES · SPECIAL PIECES

Disponible en NATURAL ANTISLIP
Available in NATURAL ANTISLIP

- DESBORDANTE**
30 x 30/2,2 (G 17) 11,8" x 11,8" ♦
- ESQ. EXT. DESBORDANTE**
30 x 30 x 41,5/2,2 (G 19 x 2)
11,8" x 11,8" x 16" ♦
- ESQ. INT. DESBORDANTE**
30 x 30 x 41,5/2,2 (G 19 x 2)
11,8" x 11,8" x 16" ♦
- GRATTING**
19 x 30/2,2 (G 18)
7" x 11,8" ♦
- ESQUINA GRATTING**
30 x 19 x 25,5/2,2 (G 20 x 2)
11,8" x 7" x 10" ♦

PIEZAS ESPECIALES · SPECIAL PIECES

Disponible en NATURAL ANTISLIP e IRON ANTISLIP
Available in NATURAL ANTISLIP & IRON ANTISLIP

- PELDAÑO ANG.**
30 x 32/4 (G 17) 13" x 13" ♦
- ÁNGULO PELDAÑO ANG.**
32 x 46/4 (G 18 x 2PZ) 13" x 18" ♦

PIEZAS ESPECIALES · SPECIAL PIECES

Disponible en WHITE ANTISLIP y GREY ANTISLIP
Available in WHITE ANTISLIP & GREY ANTISLIP

- PELDAÑO ANGULAR**
120 x 32/3 (G 72) 48" x 12,5" x 1" ♦
60 x 32/3 (G 73) 23,6" x 12,5" x 1" ♦
 - ÁNGULO PELDAÑO 120. INT**
120 x 32 x 45/3 (G 46 x 2)
48" x 12,6" x 17,7" / 1" ♦
 - ÁNGULO PELDAÑO 120. EXT**
120 x 32 x 45/3 (G 46 x 2)
48" x 12,6" x 17,7" / 1" ♦
- Consultar disponibilidad / Check availability

PIEZAS ESPECIALES · SPECIAL PIECES

Disponible en todos los colores
Available in all colors

- ZÓCALO**
7,5 x 60 (G 74) 3" x 23,6" ♦
- ZANQUÍN - IZQ. / DCHA.**
7,5 x 30 (G 12) 3" x 11,8" ♦
- REMATE PELDAÑO ANGULAR - IZQ. / DRCH.**
3 x 32 (G 15) 1" x 12,5" ♦
- BORDE PISCINA**
30 x 36/4 (G 19) 11,8" x 14" ♦
- BORDE PISCINA ESQ. INT.**
51,2 x 51,2 (G 62 x juego)
20,1" x 20,1" ♦
- BORDE PISCINA ESQ. EXT.**
51,2 x 51,2 (G 62 x juego)
20,1" x 20,1" ♦

PACKING BASES

FORMATO	PULGADAS	PZ/CAJA	M²	CAJA/PLT	PESO/CAJA	PESO/PLT
30 x 90	11,8" x 35,4"	3	0,81	40	23,5	955

PACKING PIEZAS ESPECIALES

FORMATO	PULGADAS	PZ/CAJA	ML	CAJA/PLT	PESO/CAJA	PESO/PLT
ZÓCALO 7,5 x 60	3" x 11,8"	24	14,4	66	22,9	1.526
ZANQUÍN 7,5 x 30	3" x 11,8"	30	9	48	16,24	794
PELD. ANG. 30 x 32/4	11,8" x 13"	4	1,2	54	11,94	660
ANG. PELDAÑO ANG. 32 x 46/4	13" x 18"	2	0,32	90	3,2	300
GRATTING 19 x 30/2,2	7" x 11,8"	6	3,3	56	15	850
ESQ. GRATTING 30 x 19 x 25,5/2,2	11,8" x 7" x 10"	6	3,3	56	11,4	640

PACKING PIEZAS ESPECIALES

FORMATO	PULGADAS	PZ/CAJA	ML	CAJA/PLT	PESO/CAJA	PESO/PLT
DESBORDANTE 30 x 30/2,2	11,8" x 11,8"	6	1,8	44	17,75	796
ESQ. EXT. DESBORDANTE 30 x 30 x 41,5/2,2	11,8" x 11,8" x 16"	2	0,6	90	6,3	578
ESQ. INT. DESBORDANTE 30 x 30 x 41,5/2,2	11,8" x 11,8" x 16"	2	0,6	90	6,3	578
PELDAÑO ANG. 120 x 32/3	48" x 12,5" / 1"	2	2,4	14	36,7	530
PELDAÑO ANG. 60 x 32/3	23,6" x 12,5" / 1"	2	1,2	28	18,9	542
REMATE PELDAÑO 3 x 32	1" x 12,5"	20	6,4	60	3,5	219
ANG. PELDAÑO 120 INT. 120 x 32 x 45	48" x 12,5" x 17,7"	2	2,4	14	32	450
ANG. PELDAÑO 120 EXT. 120 x 32 x 45	48" x 12,5" x 17,7"	2	2,4	14	32	450
BORDE PISCINA 30 x 36/4	11,8" x 14"	3	0,90	44	15,7	691
B. PISC. ESQ. INT. 51,2 x 51,2	20,1" x 20,1"	1	0,51	18	12,71	245
B. PISC. ESQ. EXT. 51,2 x 51,2	20,1" x 20,1"	1	0,51	18	12,71	245

RESISTE LA FLEXIÓN	RESISTE EL DESGASTE	RESISTE EL RAYADO	ANTIDESLIZANTE	ANTID.TORUS	MANCHAS	ABSORCIÓN	DILATACIÓN	
29 N/mm2	PEI (II - IV)	MOHS - 9	Class III - R11	0,80 - 0,75	Class S - Class A	<0,5%	6,0° 10°/°C	fine RESISTANCE
29 N/mm2	PEI (II - IV)	MOHS - 7	Class II - R9	0,40 - 0,55	Class S - Class A	<0,5%	6,0° 10°/°C	<i>Comfort floor</i>

- GRES EXTR. PORCELÁNICO / PORCELAIN EXTR. TILE
- PAV. DE INTERIOR / INDOOR FLOOR TILE
- PAV. DE EXTERIOR / OUTDOOR FLOOR TILE
- SUPERFICIE MATE / SURFACE MATT
- SIN MANTENIMIENTO / NO MAINTENANCE
- RES. A ÁCIDOS Y BASES / RES. TO ACIDS AND BASES
- RES. A LA HELADA / FROST PROOF
- DESTONIFICADO ARMONIOSO / CONTROLLED DESTONIFICATION



COLORES · COLORS

Comfort floor ▶ R 9 - Class II



EVEREST SUR 30 x 60 (G 57) 11,8" x 23,6" m² | EVEREST CENTRO 30 x 60 (G 57) 11,8" x 23,6" m² | EVEREST OESTE 30 x 60 (G 57) 11,8" x 23,6" m² | EVEREST ESTE 30 x 60 (G 57) 11,8" x 23,6" m² | EVEREST NORTE 30 x 60 (G 57) 11,8" x 23,6" m²

COLORES · COLORS

fine **RESISTANCE** ▶ R11 - Class III



EVEREST NIEVE 30 x 60 (G 57) 11,8" x 23,6" m² | EVEREST LLUVIA 30 x 60 (G 57) 11,8" x 23,6" m² | EVEREST TIERRA 30 x 60 (G 57) 11,8" x 23,6" m² | EVEREST PIEDRA 30 x 60 (G 57) 11,8" x 23,6" m² | EVEREST GRAFITO 30 x 60 (G 57) 11,8" x 23,6" m²



PIEZAS ESPECIALES · SPECIAL PIECES

Disponible en todos los colores · Available in all colors

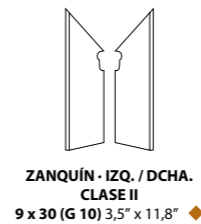
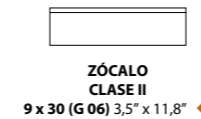

PACKING BASES

FORMATO	PULGADAS	PZ/CAJA	M ²	CAJA/PLT	PESO/CAJA	PESO/PLT
30 x 60	11,8" x 23,6"	6	1,08	48	24,82	1.205

PACKING PIEZAS ESPECIALES

FORMATO	PULGADAS	PZ/CAJA	ML	CAJA/PLT	PESO/CAJA	PESO/PLT
PELD. CURVO 30 x 33/4	11,8" x 13"	4	1,2	54	11,94	660
VIERTEAGUAS 15 x 30/4	5,9" x 11,8"	14	4,2	36	17,6	560
ZÓCALO 9 x 30	3,5" x 11,8"	30	9	56	19,6	1.112
ZANQUÍN 9 x 30	3,5" x 11,8"	30	9	56	16,24	924



▲ EVEREST SUR
CLASE II - R9

▲ EVEREST NIEVE
CLASE III - R11



▲ EVEREST CENTRO
CLASE II - R9

▲ EVEREST LLUVIA
CLASE III - R11



▲ EVEREST OESTE
CLASE II - R9

▲ EVEREST TIERRA
CLASE III - R11



▲ EVEREST ESTE
CLASE II - R9

▲ EVEREST PIEDRA
CLASE III - R11

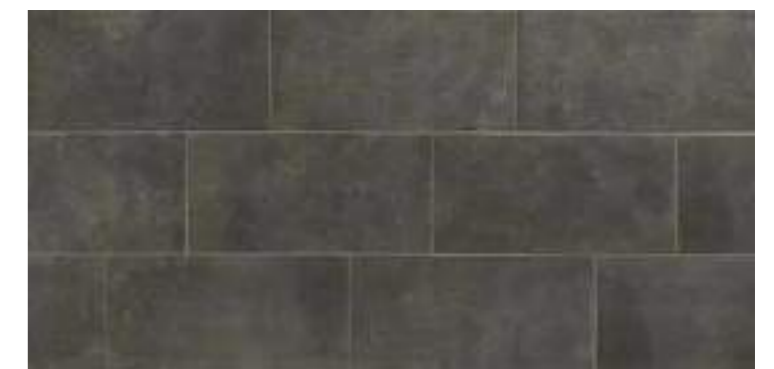

▲ EVEREST NORTE
CLASE II - R9

▲ EVEREST GRAFITO
CLASE III - R11

PALAZZO



GRANO GRUESO
COARSE GRAINED



COLORES · COLORS

Comfort floor ▶ R 9 - Class I



PIEZAS ESPECIALES · SPECIAL PIECES

Disponibile en todos los colores · Available in all colors

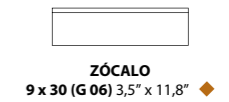

DECORACIÓN · DECORATION

Decoración serie PALAZZO completa en pág. 92-93 · Complete PALAZZO decor on pág. 92-93

30 x 30 (G 57) 11,8" x 11,8" m

Escala reducida



PALAZZO
SAN POLO



PALAZZO
SAN MARCOS



PALAZZO
SAN ROCCO

PACKING BASES

FORMATO	PULGADAS	PZ/CAJA	M²	CAJA/PLT	PESO/CAJA	PESO/PLT
30 x 30	11,8" x 11,8"	11	1	72	20,27	1,474
HEX. 36 x 41,5	14" x 16,2"	9	1	48	22,6	1,103

PACKING PIEZAS ESPECIALES

FORMATO	PULGADAS	PZ/CAJA	ML	CAJA/PLT	PESO/CAJA	PESO/PLT
ZÓCALO 9 x 30	3,5" x 11,8"	30	9	56	19,6	1,112

PALAZZO



GRANO FINO
FINE GRAINED



COLORES · COLORS

Comfort floor ▶ R 9 - Class I



PALAZZO LUCE
22,5 x 22,5 (G 25) 8,8" x 8,8" m²



PALAZZO BEIGE
22,5 x 22,5 (G 25) 8,8" x 8,8" m²



PALAZZO NUVOVA
22,5 x 22,5 (G 25) 8,8" x 8,8" m²



PALAZZO COLORI
22,5 x 22,5 (G 25) 8,8" x 8,8" m²

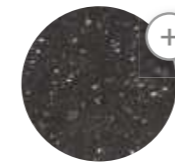

PALAZZO NERO
22,5 x 22,5 (G 25) 8,8" x 8,8" m²



PALAZZO LUCE
7,5 x 30 (G 56) 3" x 11,8" m²



PALAZZO BEIGE
7,5 x 30 (G 56) 3" x 11,8" m²



PALAZZO NUVOVA
7,5 x 30 (G 56) 3" x 11,8" m²



PALAZZO COLORI
7,5 x 30 (G 56) 3" x 11,8" m²



PALAZZO NERO
7,5 x 30 (G 56) 3" x 11,8" m²

DECORACIÓN · DECORATION

Decoración serie PALAZZO completa en pág. 86-91 · Complete PALAZZO decor on pág. 86-91

22,5 x 22,5 (G 57) 8,8" x 8,8" m²

Escala reducida



PALAZZO MEDICI

PALAZZO LUIGI

PALAZZO DUCALE

PALAZZO RIALTO

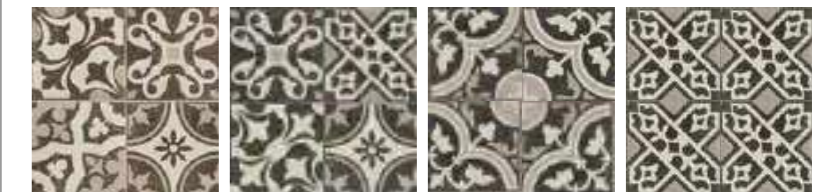

PALAZZO BALBI COLORI

PALAZZO BALBI

PALAZZO PIERO

PALAZZO NICOLA

7,5 x 30 (G 56) 3" x 11,8" m²

Escala reducida

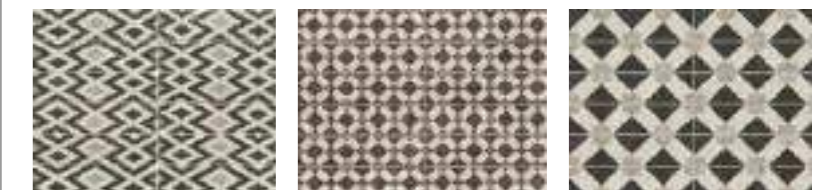

PALAZZO SAN NICCOLO

PALAZZO SAN LORENZO

PALAZZO SAN GIACOMO

PACKING BASES

FORMATO	PULGADAS	PZ/CAJA	M ²	CAJA/PLT	PESO/CAJA	PESO/PLT
22,5 x 22,5	8,8" x 8,8"	20	1,01	72	20,27	1.474
7,5 x 30	3" x 11,8"	22	0,5	120	10,25	1.245

ROCKS

fineRESISTANCE
R11 - Class III

EVOLUTION
EXTRUDED PORCELAIN TILE

ANTI-BACTERIAL
AntiSlip - R11

RESISTE LA FLEXIÓN
32 N/mm2

RESISTE EL DESGASTE
PEI (III - IV)

RESISTE EL RAYADO
MOHS - 8

ANTIDESLIZANTE
Class III - R11

MANCHAS
Class 5 - Class A

ABSORCIÓN
<0,5%

DILATACIÓN
6,0° 10° / °C

ANTIBACTERIANO
Norma JIS Z 2801

PE GRES EXTRUSIONADO PORCELÁNICO
PORCELAIN EXTRUDED TILE

PAV. DE EXTERIOR
OUTDOOR FLOOR TILE

SUPERFICIE MATE
SURFACE MATT

SIN MANTENIMIENTO
NO MAINTENANCE

RES. A ÁCIDOS Y BASES
RES. TO ACIDS AND BASES

RES. A LA HELADA
FROST PROOF

DESTONIFICADO ARMONIOSO
CONTROLLED DESTONIFICATION



COLORES · COLORS

fineRESISTANCE ▶ R11 - Class III



ROCKS WHITE
30 x 60 (G 57) 11,8" x 23,6" m²



ROCKS BEIGE
30 x 60 (G 57) 11,8" x 23,6" m²



ROCKS BROWN
30 x 60 (G 57) 11,8" x 23,6" m²

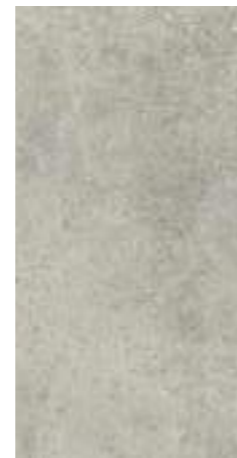

ROCKS GREY
30 x 60 (G 57) 11,8" x 23,6" m²



ROCKS DARK
30 x 60 (G 57) 11,8" x 23,6" m²

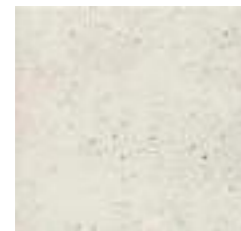

ROCKS WHITE
30 x 30 (G 25) 11,8" x 11,8" m²



ROCKS BEIGE
30 x 30 (G 25) 11,8" x 11,8" m²



ROCKS BROWN
30 x 30 (G 25) 11,8" x 11,8" m²



ROCKS GREY
30 x 30 (G 25) 11,8" x 11,8" m²



ROCKS DARK
30 x 30 (G 25) 11,8" x 11,8" m²



ROCKS WHITE
36 x 36 (G 57) 14" x 14" m²



ROCKS BEIGE
36 x 36 (G 57) 14" x 14" m²



ROCKS BROWN
36 x 36 (G 57) 14" x 14" m²



ROCKS GREY
36 x 36 (G 57) 14" x 14" m²



ROCKS DARK
36 x 36 (G 57) 14" x 14" m²

PIEZAS ESPECIALES · SPECIAL PIECES

Disponibles en todos los colores · Available in all colors

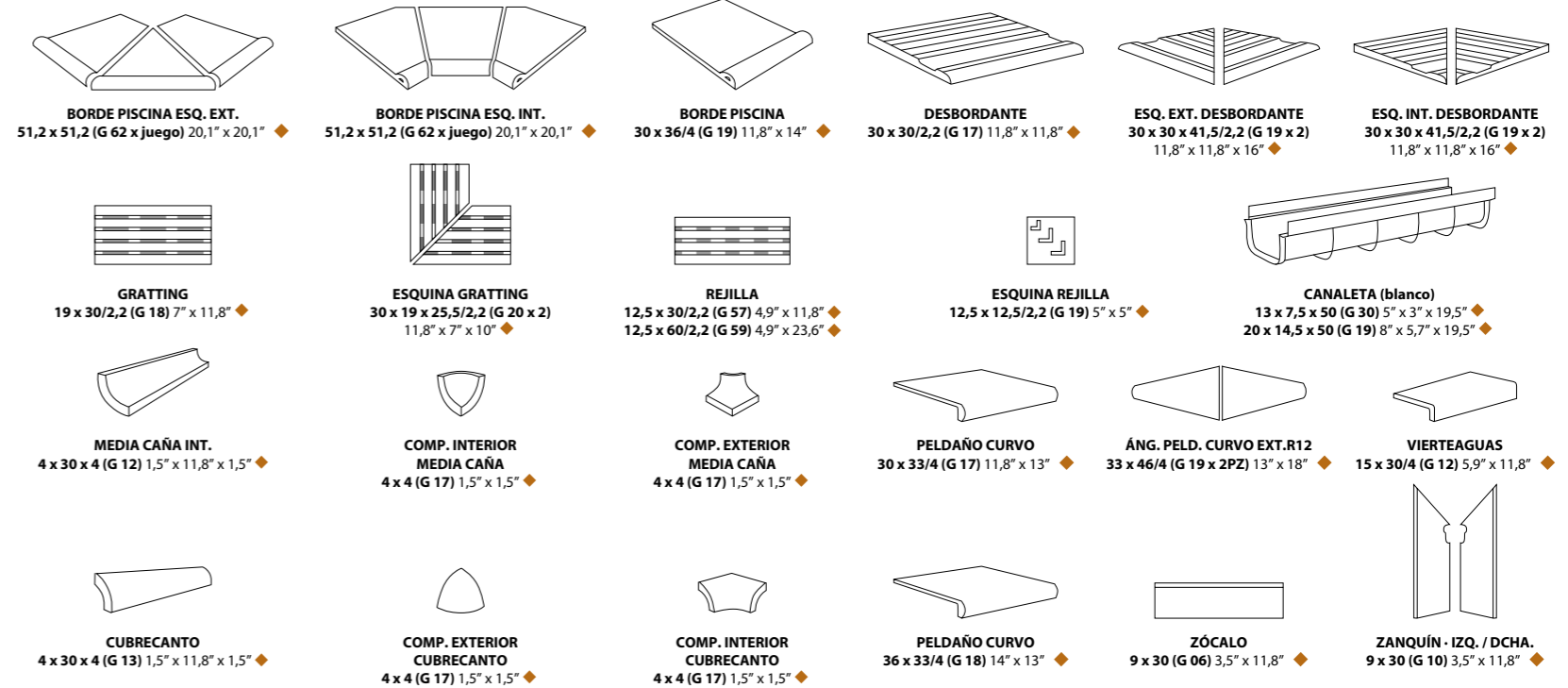

PACKING BASES

FORMATO	PULGADAS	PZ/CAJA	M²	CAJA/PLT	PESO/CAJA	PESO/PLT
36 x 36	14" x 14"	8	1	48	22,04	1.072
30 x 30	11,8" x 11,8"	11	1	72	20,27	1.474
30 x 60	11,8" x 23,6"	6	1,08	48	24,82	1.205

PACKING PIEZAS ESPECIALES

FORMATO	PULGADAS	PZ/CAJA	ML	CAJA/PLT	PESO/CAJA	PESO/PLT
ANG. PELD. CURVO 33 x 46/4	13" x 18"	2	0,33	90	3,46	325
PELD. CURVO 30 x 33/4	11,8" x 13"	4	1,2	54	11,94	660
PELD. CURVO 36 x 33/4	14" x 13"	4	1,44	54	13,40	740
VIERTEAGUAS 15 x 30/4	5,9" x 11,8"	14	4,2	36	17,6	560
MEDIA CAÑA INT. 4 x 30 x 4	1,5" x 11,8" x 1,5"	22	6,6	-	9,91	-
COMP. EXT. MEDIA CA. 4 x 4	1,5" x 1,5"	18	0,6	-	1,34	-
COMP. INT. MEDIA CA. 4 x 4	1,5" x 1,5"	20	0,66	-	1,84	-
CUBRECANTO 4 x 30 x 4	1,5" x 11,8" x 1,5"	26	7,8	-	7,33	-
COMP. EXT. CUBRECAN. 4 x 4	1,5" x 1,5"	25	0,83	-	0,55	-

PACKING PIEZAS ESPECIALES

FORMATO	PULGADAS	PZ/CAJA	ML	CAJA/PLT	PESO/CAJA	PESO/PLT
COMP. INT. CUBRECAN. 4 x 4	1,5" x 1,5"	10	0,33	-	0,85	-
BORDE PISC. ESQ. EXT. 51,2 x 51,2	20,1" x 20,1"	1	0,51	18	12,71	245
BORDE PISC. ESQ. INT. 51,2 x 51,2	20,1" x 20,1"	1	0,51	18	12,71	245
BORDE PISCINA 30 x 36/4	11,8" x 14"	3	0,9	44	15,7	691
GRATTING 19 x 30/2,2	7" x 11,8"	6	3,3	56	15	850
ESQ. GRATTING 30 x 19 x 25,5/2,2	11,8" x 7" x 10"	6	3,3	56	11,4	640
REJILLA 12,5 x 60	5" x 23,6"	6	3,6	66	16,55	1.092
REJILLA 12,5 x 30	5" x 11,8"	10	3	36	20,4	735
ESQUINA REJILLA 12,5 x 12,5/2,2	4,9" x 4,9"	-	-	-	-	-
ZANQUÍN 9 x 30	3,5" x 11,8"	30	9	56	16,24	924
ZÓCALO 9 x 30	3,5" x 11,8"	30	9	56	19,6	1.112
DESBORDANTE 30 x 30/2,2	11,8" x 11,8"	6	1,8	44	17,75	796
ESQ. EXT. DESB. 30 x 30 x 41,5/2,2	11,8" x 11,8" x 16"	2	0,6	90	6,3	578
ESQ. INT. DESB. 30 x 30 x 41,5/2,2	11,8" x 11,8" x 16"	2	0,6	90	6,3	578
CANALETA 13 x 7,5 x 50	5" x 3" x 19,5"	24	12	20	13,5	300
CANALETA 20 x 14,5 x 50	8" x 5,7" x 19,5"	12	6	20	10,5	225

TECH • GEO



14 mm
ESPESOR



TECH GEO GLACIER 22,5 x 33 - 8,8" x 13" - TECH GEO GLACIER 22,5 x 22,5 - 8,8" x 8,8"
TECH GEO GLACIER 11 x 22,5 - 4,3" x 8,8"



TECH GEO RIVER 22,5 x 22,5 - 8,8" x 8,8" - TECH GEO RIVER 11 x 22,5 - 4,3" x 8,8"

COLORES • COLORS

14 mm
ESPESOR



TECH GEO GLACIER
11 x 22,5 (G 39) 4,3" x 8,8" m²



TECH GEO RIVER
11 x 22,5 (G 39) 4,3" x 8,8" m²



TECH GEO MOUNTAIN
11 x 22,5 (G 39) 4,3" x 8,8" m²



TECH GEO VOLCANO
11 x 22,5 (G 39) 4,3" x 8,8" m²



TECH GEO GLACIER
22,5 x 22,5 (G 58) 8,8" x 8,8" m²



TECH GEO RIVER
22,5 x 22,5 (G 58) 8,8" x 8,8" m²



TECH GEO MOUNTAIN
22,5 x 22,5 (G 58) 8,8" x 8,8" m²



TECH GEO VOLCANO
22,5 x 22,5 (G 58) 8,8" x 8,8" m²



TECH GEO GLACIER
22,5 x 33 (G 58) 8,8" x 13" m²



TECH GEO RIVER
22,5 x 33 (G 58) 8,8" x 13" m²



TECH GEO MOUNTAIN
22,5 x 33 (G 58) 8,8" x 13" m²



TECH GEO VOLCANO
22,5 x 33 (G 58) 8,8" x 13" m²



TECH GEO MOUNTAIN 22,5 x 33 - 8,8" x 13" - TECH GEO MOUNTAIN 22,5 x 22,5 - 8,8" x 8,8"
TECH GEO MOUNTAIN 11 x 22,5 - 4,3" x 8,8"



TECH GEO VOLCANO 22,5 x 22,5 - 8,8" x 8,8" - TECH GEO VOLCANO 11 x 22,5 - 4,3" x 8,8"

APLICACIONES • APPLICATIONS



ZONAS RESIDENCIALES
RESIDENTIAL AREAS



PASEOS URBANOS
URBAN AREAS



TERRAZAS Y PATIOS
TERRACE & PATIOS



ZONAS COMERCIALES
COMMERCIAL AREAS



PISCINAS
SWIMMING POOLS



JARDINES
GARDENS



ZONAS TRANSITABLES
HIGH TRAFFIC AREAS

PACKING BASES

FORMATO	PULGADAS	PZ/CAJA	M ²	CAJA/PLT	PESO/CAJA	PESO/PLT
22,5 x 33	8,8" x 13"	11	0,82	68	23,3	1.600
22,5 x 22,5	8,8" x 8,8"	17	0,86	60	24,8	1.503
11 x 22,5	4,3" x 8,8"	20	0,5	112	13,7	1.550

PACKING PIEZAS ESPECIALES

FORMATO	PULGADAS	PZ/CAJA	ML	CAJA/PLT	PESO/CAJA	PESO/PLT
PELDAÑO CURVO 22,5 x 33/4	8,8" x 13"	6	13,5	64	12	785
ANG. PELD. CURVO 1PZ 33 x 33/4	13" x 13"	1	0,33	90	3,7	333
ZÓCALO 9 x 30	3,5" x 11,8"	30	9	48	19,60	955
ZANQUÍN 9 x 30	3,5" x 11,8"	30	9	48	16,24	794

PIEZAS ESPECIALES • SPECIAL PIECES

Disponible en todos los colores • Available in all colors



PELDAÑO CURVO
22,5 x 33/4 (G 16) 8,8" x 13" ◆



ÁNGULO PELDAÑO CURVO 1PZ.
33 x 33/4 (G 56) 13" x 13" ◆

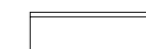

ZÓCALO
9 x 30 (G 06) 3,5" x 11,8" ◆

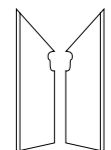

ZANQUÍN - IZQ. / DCHA.
9 x 30 (G 10) 3,5" x 11,8" ◆

MONTE



FORMATO
 30 x 60 - 11,8" x 23,6"
 30 x 30 - 11,8" x 11,8"
 10 x 60 - 4" x 23,6"
 NAVETA 18,5 x 42 - 7" x 16,4"
 HEX. 36 x 41,5 - 14" x 16,2"



PIEZAS ESPECIALES · SPECIAL PIECES

Disponible en BLAT, TORTOLA y PEDRA
 Available in BLAT, TORTOLA & PEDRA



PELDAÑO ANGULAR
 120 x 32/2,5 (G 42) 48" x 12,5"/1"
 60 x 32/2,5 (G 57) 23,6" x 12,5"/1"

REMATE PELDAÑO ANGULAR - IZQ. / DRCH.
 2,5 x 32 (G 15) 1" x 12,5"

COLORES DISPONIBLES:
 Remate Peldaño Angular CAVA combinable con TORTOLA y BLAT
 Remate Peldaño Angular PIMIENTA combinable con PEDRA



DECORACIÓN · DECORATION

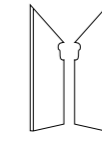

ZANQUÍN 2,5 A - IZQ. / DRCH.
 9 x 30 (G 11) 3,5" x 11,8"



FRONTAL STONE
 15,5 x 30 (G 12) 6" x 11,8"

PIEZAS ESPECIALES · SPECIAL PIECES

Disponible en todos los colores · Available in all colors

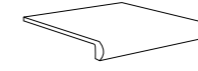

PELDAÑO CURVO
 30 x 33/4 (G 17) 11,8" x 13"

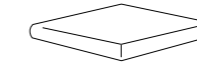

ÁNGULO PELDAÑO CURVO 1PZ.
 33 x 33/4 (G 56) 13" x 13"

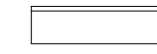

ZÓCALO
 9 x 30 (G 06) 3,5" x 11,8"

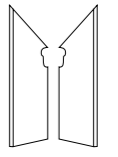

ZANQUÍN - IZQ. / DCHA.
 9 x 30 (G 10) 3,5" x 11,8"

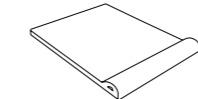

BORDE PISCINA MONTE
 30 x 36/4 (G 19) 11,8" x 14"

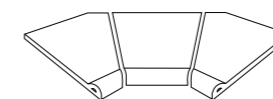

BORDE PISCINA ESQ. INT. MONTE
 51,2 x 51,2 (G 62 x juego) 20,1" x 20,1"

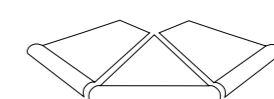

BORDE PISCINA ESQ. EXT. MONTE
 51,2 x 51,2 (G 62 x juego) 20,1" x 20,1"



VIERTEAGUAS
 15 x 30/4 (G 12) 5,9" x 11,8"

COLORES · COLORS



MONTE BLAT HEX.
 36 x 41,5 (G 58) 14" x 16,2"



MONTE BLAT NAVETA
 18,5 x 42 (G 39) 7" x 16,4"



MONTE CANYELLA HEX.
 36 x 41,5 (G 58) 14" x 16,2"



MONTE CANYELLA NAVETA
 18,5 x 42 (G 39) 7" x 16,4"



MONTE TORTOLA HEX.
 36 x 41,5 (G 58) 14" x 16,2"



MONTE TORTOLA NAVETA
 18,5 x 42 (G 39) 7" x 16,4"

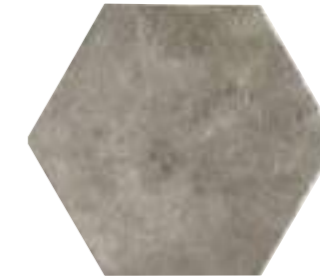

MONTE PEDRA HEX.
 36 x 41,5 (G 58) 14" x 16,2"



MONTE PEDRA NAVETA
 18,5 x 42 (G 39) 7" x 16,4"



MONTE BLAT
 30 x 60 (G 38) 11,8" x 23,6"



MONTE BLAT
 30 x 30 (G 25) 11,8" x 11,8"



MONTE CANYELLA
 30 x 60 (G 38) 11,8" x 23,6"



MONTE CANYELLA
 30 x 30 (G 25) 11,8" x 11,8"



MONTE TORTOLA
 30 x 60 (G 38) 11,8" x 23,6"



MONTE TORTOLA
 30 x 30 (G 25) 11,8" x 11,8"



MONTE PEDRA
 30 x 60 (G 38) 11,8" x 23,6"



MONTE PEDRA
 30 x 30 (G 25) 11,8" x 11,8"



MONTE BLAT
 10 x 60 (G 27) 4" x 23,6"



MONTE CANYELLA
 10 x 60 (G 27) 4" x 23,6"



MONTE TORTOLA
 10 x 60 (G 27) 4" x 23,6"



MONTE PEDRA
 10 x 60 (G 27) 4" x 23,6"

PACKING BASES

FORMATO	PULGADAS	PZ/CAJA	M ²	CAJA/PLT	PESO/CAJA	PESO/PLT
30 x 30	11,8" x 11,8"	11	1	72	20,27	1474
30 x 60	11,8" x 23,6"	6	1,08	48	24,82	1.205
10 x 60	4" x 23,6"	16	0,96	72	20,9	1.519
HEX. 36 x 41,5	14" x 16,2"	9	1	48	22,6	1.103
NAVETA 18,5 x 42	7" x 16,4"	13	1,01	64	19,93	1.289

PACKING DECORADO

FORMATO	PULGADAS	PZ/CAJA	ML	CAJA/PLT	PESO/CAJA	PESO/PLT
15,5 x 30	6" x 11,8"	15	4,5	56	14,9	850

PACKING PIEZAS ESPECIALES

FORMATO	PULGADAS	PZ/CAJA	M ² /ML	CAJA/PLT	PESO/CAJA	PESO/PLT
PELD. CURVO 30 x 33 / 4	11,8" x 13"	4	1,2	54	11,94	660
ANG. PEL. CURVO 1PZA 33 x 33/4	13" x 13"	1	0,33	90	3,7	348
VIERTEAGUAS 15 x 30/4	5,9" x 11,8"	14	4,2	48	15,08	738
ZÓCALO 9 x 30	3,5" x 11,8"	30	9	56	19,6	1.112
ZANQUIN 9 x 30	3,5" x 11,8"	30	9	56	16,24	924
BORDE PISCINA 30 x 36/4	11,8" x 14"	3	0,9	40	15,7	643

PACKING PIEZAS ESPECIALES

FORMATO	PULGADAS	PZ/CAJA	M ² /ML	CAJA/PLT	PESO/CAJA	PESO/PLT
BORDE PISC. ESQ. EXT. 51,2 x 51,2	20,1" x 20,1"	1	0,51	18	12,71	245
BORDE PISC. ESQ. INT. 51,2 x 51,2	20,1" x 20,1"	1	0,51	18	12,71	245
PELDAÑO ANG. 120 x 32/2,5	48" x 12,5"/1"	2	2,4	14	36,7	530
PELDAÑO ANG. 60 x 32/2,5	23,6" x 12,5"/1"	2	1,2	28	18,9	542
ZANQUIN 2,5 A 9 x 30	3,5" x 11,8"	30	9	48	16,24	794
REMATE PELDAÑO 2,5 x 32	1" x 12,5"	20	6,4	60	3,5	219

GRAND CANYON



RESISTE LA FLEXIÓN	RESISTE EL DESGASTE	RESISTE EL RAYADO	ANTIDESLIZANTE	ANTID. TORUS	MANCHAS	ABSORCIÓN	DILATACIÓN
29 N/m2	PEI (III - IV)	MOHS - 9	Class III - R13	0.85 - 0.82	Class 5 - Class A	0,3%	5,7° 10° / °C

GRES EXTRUS. PORCELÁNICO PORCELAIN EXTRUDED TILE	PAV. DE EXTERIOR OUTDOOR FLOOR TILE	MODULARIDAD MODULARITY	SUPERFICIE MATE SURFACE MATT	SIN MANTENIMIENTO NO MAINTENANCE	RES. A ÁCIDOS Y BASES RES. TO ACIDS AND BASES	RES. A LA HELADA FROST PROOF	DESTONIFICADO ARMONIOSO CONTROLLED DESTONIFICATION



COLORES · COLORS



GRAND CANYON NEVADA
22,5 x 45 (G 25) 8,8" x 17,7"



GRAND CANYON NEVADA
22,5 x 22,5 (G 25) 8,8" x 8,8"



GRAND CANYON ARIZONA
22,5 x 45 (G 25) 8,8" x 17,7"



GRAND CANYON ARIZONA
22,5 x 22,5 (G 25) 8,8" x 8,8"



GRAND CANYON UTAH
22,5 x 45 (G 25) 8,8" x 17,7"



GRAND CANYON UTAH
22,5 x 22,5 (G 25) 8,8" x 8,8"



GRAND CANYON NEVADA
30 x 45 (G 57) 11,8" x 17,7"



GRAND CANYON NEVADA
30 x 30 (G 25) 11,8" x 11,8"



GRAND CANYON ARIZONA
30 x 45 (G 57) 11,8" x 17,7"



GRAND CANYON ARIZONA
30 x 30 (G 25) 11,8" x 11,8"



GRAND CANYON UTAH
30 x 45 (G 57) 11,8" x 17,7"



GRAND CANYON UTAH
30 x 30 (G 25) 11,8" x 11,8"



GRAND CANYON NEVADA
6,5 x 25 (G 39) 2,5" x 10"



GRAND CANYON NEVADA TRAB. ENM.
25 x 50 (G 60) 10" x 20"



GRAND CANYON UTAH
6,5 x 25 (G 39) 2,5" x 10"



GRAND CANYON UTAH TRAB. ENM.
25 x 50 (G 60) 10" x 20"

MODULACIÓN · MODULATION

Disponible en todos los colores · Available in all colors

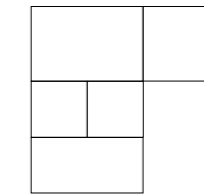

GRAND CANYON MODULO A (G 38)
packing: 0,86 m²/caja

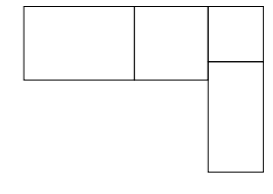

GRAND CANYON MODULO B (G 38)
packing: 1,13 m²/caja

Escala a un 75% de la utilizada en este catálogo.

PIEZAS ESPECIALES · SPECIAL PIECES

Disponible en todos los colores · Available in all colors

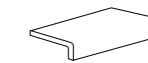

VIERTEAGUAS
15 x 30/4 (G 12) 5,9" x 11,8"
15 x 22,5/4 (G 10) 5,9" x 8,8"

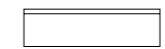

ZÓCALO
9 x 30 (G 06) 3,5" x 11,8"
9 x 22,5 (G 05) 3,5" x 8,8"

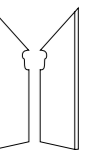

ZANQUÍN - IZQ. / DCHA.
9 x 30 (G 10) 3,5" x 11,8"



PELDAÑO CURVO
30 x 33/4 (G 17) 11,8" x 13"



ÁNGULO PELDAÑO CURVO 1PZ.
33 x 33/4 (G 56) 13" x 13"

PACKING BASES

FORMATO	PULGADAS	PZ/CAJA	M ²	CAJA/PLT	PESO/CAJA	PESO/PLT
30 x 45	11,8" x 17,7"	8	1,08	48	22,9	1.113
30 x 30	11,8" x 11,8"	11	1	72	20,27	1474
22,5 x 45	8,8" x 17,7"	10	1,01	72	20,97	1524
22,5 x 22,5	8,8" x 8,8"	20	1,01	72	20,74	1.507

PACKING BASES

FORMATO	PULGADAS	PZ/CAJA	M ²	CAJA/PLT	PESO/CAJA	PESO/PLT
6,5 x 25	2,5" x 10"	27	0,439	176	9,31	1657
TRAB. ENM. 25 x 50	10" x 20"	6	0,75	52	14,1	753
MODULO A	-	10	0,86	48	18,21	888
MODULO B	-	12	1,13	40	24,1	978

PACKING PIEZAS ESPECIALES

FORMATO	PULGADAS	PZ/CAJA	ML	CAJA/PLT	PESO/CAJA	PESO/PLT
ANG. PELD. CURVO 1PZ 33 x 33/4	13" x 13"	1	0,33	90	3,7	333
PELD. CURVO 30 x 33/4	11,8" x 13"	4	1,2	54	11,94	660
VIERTEAGUAS 15 x 30/4	5,9" x 11,8"	14	4,2	48	17,6	859
VIERTEAGUAS 15 x 22,5/4	5,9" x 8,8"	14	3,15	48	15,08	739

PACKING PIEZAS ESPECIALES

FORMATO	PULGADAS	PZ/CAJA	ML	CAJA/PLT	PESO/CAJA	PESO/PLT
ZÓCALO 9 x 30	3,5" x 11,8"	30	9	56	19,6	1.112
ZÓCALO 9 x 22,5	3,5" x 8,8"	40	9	60	19,7	1.197
ZANQUÍN 9 x 30	3,5" x 11,8"	30	9	56	16,24	924

GRANITE



COLORES · COLORS



MODULACIÓN · MODULATION

Disponible en todos los colores · Available in all colors

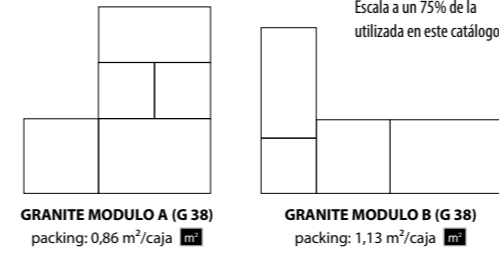

ENMALLADOS · ON A MESH



COLORES · COLORS



PIEZAS ESPECIALES · SPECIAL PIECES

Disponible en todos los colores · Available in all colors

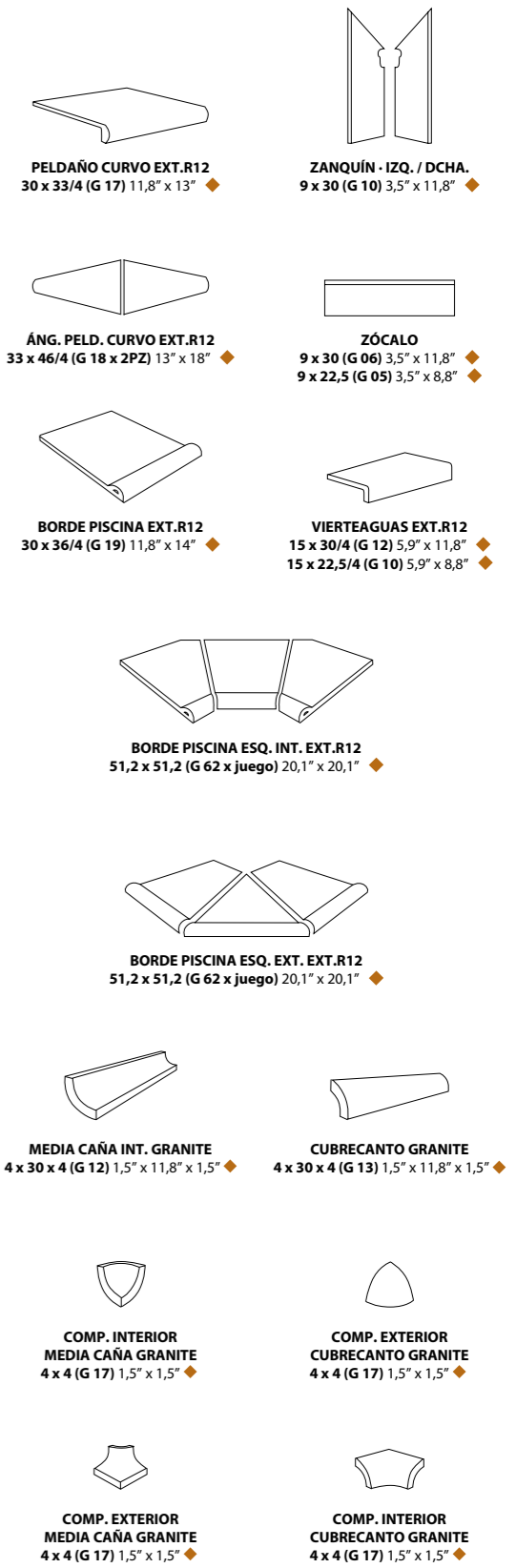

PACKING BASES

FORMATO	PULGADAS	PZ/CAJA	M ²	CAJA/PLT	PESO/CAJA	PESO/PLT
30 x 45	11,8" x 17,7"	8	1,08	48	22,9	1.113
30 x 30	11,8" x 11,8"	11	1	72	20,27	1474
22,5 x 45	8,8" x 17,7"	10	1,01	72	20,97	1524
22,5 x 22,5	8,8" x 8,8"	20	1,01	72	20,74	1.507
30 x 30 ENM.	11,8" x 11,8"	11	1	72	22,43	1.629

PACKING BASES

FORMATO	PULGADAS	PZ/CAJA	M ²	CAJA/PLT	PESO/CAJA	PESO/PLT
6,5 x 25	2,5" x 10"	27	0,439	176	9,31	1657
TRAB. ENM. 25 x 50	10" x 20"	6	0,75	52	14,1	753
MODULO A	-	10	0,86	48	18,21	888
MODULO B	-	12	1,13	40	24,1	978

PACKING PIEZAS ESPECIALES

FORMATO	PULGADAS	PZ/CAJA	ML	CAJA/PLT	PESO/CAJA	PESO/PLT
ANG. PELD. CURVO 33 x 46/4	13" x 18"	2	0,33	90	3,46	325
PELD. CURVO 30 x 33/4	11,8" x 13"	4	1,2	54	11,94	660
VIERTEGUAS 15 x 30/4	5,9" x 11,8"	14	4,2	48	17,6	859
VIERTEGUAS 15 x 22,5/4	5,9" x 8,8"	14	3,15	48	15,08	739
BORDE PISCINA 30 x 36/4	11,8" x 14"	3	0,9	40	15,7	643
BORDE PISC. ESQ. INT. 51,2 x 51,2	20,1" x 20,1"	1	0,51	18	12,71	245
BORDE PISC. ESQ. EXT. 51,2 x 51,2	20,1" x 20,1"	1	0,51	18	12,71	245
MEDIA CAÑA INT. 4 x 30 x 4	1,5" x 11,8" x 1,5"	22	6,6	-	9,91	-

PACKING PIEZAS ESPECIALES

FORMATO	PULGADAS	PZ/CAJA	ML	CAJA/PLT	PESO/CAJA	PESO/PLT
COMP. EXT. MEDIA CA. 4 x 4	1,5" x 1,5"	18	0,6	-	1,34	-
COMP. INT. MEDIA CA. 4 x 4	1,5" x 1,5"	20	0,66	-	1,84	-
CUBRECANTO 4 x 30 x 4	1,5" x 11,8" x 1,5"	26	7,8	-	7,33	-
COMP. EXT. CUBRECANTO 4 x 4	1,5" x 1,5"	25	0,83	-	0,55	-
COMP. INT. CUBRECANTO 4 x 4	1,5" x 1,5"	10	0,33	-	0,85	-
ZANQUIN 9 x 30	3,5" x 11,8"	30	9	56	16,24	924
ZÓCALO 9 x 30	3,5" x 11,8"	30	9	56	19,6	1.112
ZÓCALO 9 x 22,5	3,5" x 8,8"	40	9	60	19,7	1.197

STONE KLINKER



EVOLUTION
EXTRUDED PORCELAIN TILE



AntiSlip

30 N/mm2	PEI (III - IV)	MOHS - 8	Class III - R10	0,84 - 0,77	Class 5 - Class A	0,2%	5,7° 10°/°C	fine RESISTANCE
30 N/mm2	PEI (III - IV)	MOHS - 5	Class I	0,53 - 0,29	Class 5 - Class A	0,2%	5,7° 10°/°C	Confort floor

fine RESISTANCE								
	PORCELAIN EXTRUDED TILE	OUTDOOR FLOOR TILE	SURFACE MATT	RES. TO ACIDS & BASES	FROST PROOF	CONTROLLED DESTONIF.	NO MAINTENANCE	MODULARITY

Confort floor								
	PORCELAIN EXTRUDED TILE	INDOOR FLOOR TILE	GLOSSY SURFACE	RES. TO ACIDS & BASES	FROST PROOF	CONTROLLED DESTONIF.	NO MAINTENANCE	MODULARITY



COLORES · COLORS — Confort floor ▶ Class I



STONE KLINKER BONE
18 x 18 (G 57) 7" x 7"



STONE KLINKER BONE
18 x 36 (G 57) 7" x 14"

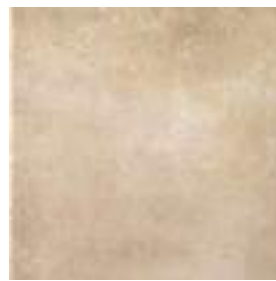

STONE KLINKER BONE
36 x 36 (G 57) 14" x 14"



STONE KLINKER DESERT
18 x 18 (G 57) 7" x 7"



STONE KLINKER DESERT
18 x 36 (G 57) 7" x 14"

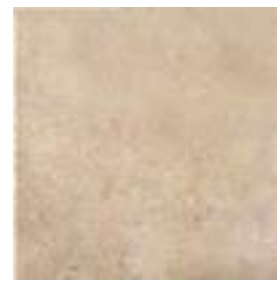

STONE KLINKER DESERT
36 x 36 (G 57) 14" x 14"



STONE KLINKER TOBACCO
18 x 18 (G 57) 7" x 7"



STONE KLINKER TOBACCO
18 x 36 (G 57) 7" x 14"



STONE KLINKER TOBACCO
36 x 36 (G 57) 14" x 14"



STONE KLINKER GROUND
18 x 18 (G 57) 7" x 7"



STONE KLINKER GROUND
18 x 36 (G 57) 7" x 14"



STONE KLINKER GROUND
36 x 36 (G 57) 14" x 14"

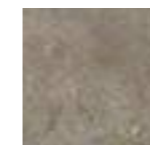

STONE KLINKER PARK
18 x 18 (G 57) 7" x 7"



STONE KLINKER PARK
18 x 36 (G 57) 7" x 14"



STONE KLINKER PARK
36 x 36 (G 57) 14" x 14"

fine RESISTANCE ▶ R10 - Class III

DECORACIÓN · DECORATION

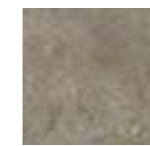

STONE KLINKER PARK
18 x 18 (G 57) 7" x 7"



STONE KLINKER PARK
18 x 36 (G 57) 7" x 14"



STONE KLINKER PARK
36 x 36 (G 57) 14" x 14"



FRONTAL MOSAICO TACO STONE K.
15,5 x 36 (G 16) 6" x 14"



FRONTAL MOSAICO TIRA STONE K.
15,5 x 36 (G 16) 6" x 14"

CENTRO MOSAICO TIRA STONE K.
36 x 36 (G 19) 14" x 14"

MODULACIÓN · MODULATION — Confort floor | fine RESISTANCE

Disponibles en CLASE I y CLASE III - R10

Available in CLASS I & CLASS III - R10

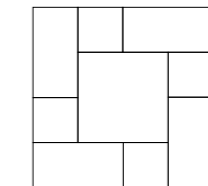

STONE KLINKER MODULO C (G 56)
packing: 1,04 m²/caja

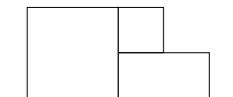

STONE KLINKER MODULO D (G 56)
packing: 0,91 m²/caja

Escala a un 75% de la utilizada en este catálogo.

PIEZAS ESPECIALES · SPECIAL PIECES

Disponibles en todos los colores · Available in all colors

SE FABRICAN EN CLASE III - R10

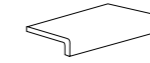

VIERTEAGUAS
15 x 36/4 (G 14) 5,9" x 14"

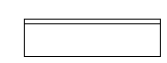

ZÓCALO
9 x 36 (G 07) 3,5" x 14"

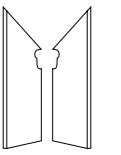

ZANQUÍN - IQ. / DCHA.
9 x 36 (G 10) 3,5" x 14"



PELDAÑO CURVO
36 x 33/4 (G 18) 14" x 13"

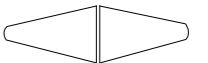

ÁNGULO PELDAÑO
33 x 46/4 (G 19 x 2PZ) 13" x 18"

PACKING BASES

FORMATO	PULGADAS	PZ/CAJA	M ²	CAJA/PLT	PESO/CAJA	PESO/PLT
36 x 36	14" x 14"	8	1	48	22,04	1072
18 x 36	7" x 14"	16	1	72	23,33	1694
18 x 18	7" x 7"	30	0,97	72	21,4	1.555
MODULO C	-	18	1,04	48	23	1.120
MODULO D	-	12	0,91	64	20	1.300

PACKING PIEZAS ESPECIALES

FORMATO	PULGADAS	PZ/CAJA	ML	CAJA/PLT	PESO/CAJA	PESO/PLT
PELD. CURVO 36 x 33/4	14" x 13"	4	1,44	54	13,36	736
ANG. PELD. 33 x 46/4	13" x 18"	2	0,33	90	3,46	325
VIERTEAGUAS 15 x 36/4	5,9" x 14"	8	2,88	48	12,1	604
ZÓCALO 9 x 36	3,5" x 14"	30	10,8	56	23,8	1.275
ZANQUÍN 9 x 36	3,5" x 14"	30	10,8	56	19,6	1.135

PACKING DECORADO

FORMATO	PULGADAS	PZ/CAJA	ML	CAJA/PLT	PESO/CAJA
CENTRO 36 x 36	14" x 14"	11	3,96	48	31,34
FRONTAL 15,5 x 36	6" x 14"	12	4,32	72	14,5

Pietra di
Firenze

fine **RESISTANCE**
R12 - CLASS III

EVOLUTION
EXTRUDED PORCELAIN TILE

AntiSlip

RESISTE LA FLEXIÓN 33 N/m2	RESISTE EL DESGASTE PEI (III - IV)	RESISTE EL RAYADO MOHS - 9	ANTIDESLIZANTE Class III - R12	ANTID. TORUS 0,88 - 0,85	MANCHAS Class 5 - Class A	ABSORCIÓN 0,1%	DILATACIÓN 6,5* 10 ⁻⁶ / °C
-------------------------------	---------------------------------------	-------------------------------	-----------------------------------	-----------------------------	------------------------------	-------------------	--

GRES EXTRUSIONADO PORCELÁNICO PORCELAIN EXTRUDED TILE	PAV. DE EXTERIOR OUTDOOR FLOOR TILE	SUPERFICIE MATE SURFACE MATT	SIN MANTENIMIENTO NO MAINTENANCE	RES. A ÁCIDOS Y BASES RES. TO ACIDS AND BASES	RES. A LA HELADA FROST PROOF	DESTONIFICADO ARMONIOSO CONTROLLED DESTONIFICATION
--	--	---------------------------------	-------------------------------------	--	---------------------------------	---



COLORES · COLORS

fine **RESISTANCE** ▶ R12 - Class III

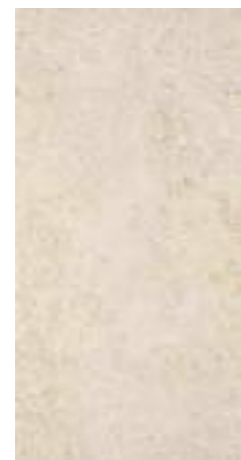

PIETRA DI FIRENZE ALBINO
30 x 60 (G 56) 11,8" x 23,6" m²

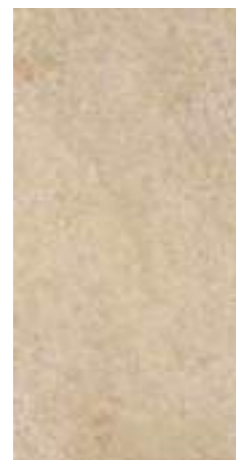

PIETRA DI FIRENZE NOCCIOLA
30 x 60 (G 56) 11,8" x 23,6" m²

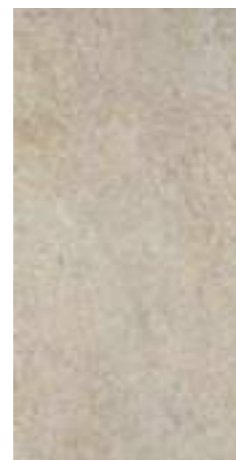

PIETRA DI FIRENZE GIADA
30 x 60 (G 56) 11,8" x 23,6" m²

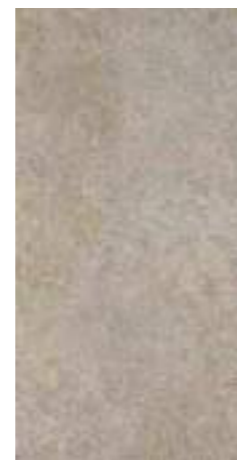

PIETRA DI FIRENZE NEBBIA
30 x 60 (G 56) 11,8" x 23,6" m²



PIETRA DI FIRENZE NERO
30 x 60 (G 56) 11,8" x 23,6" m²

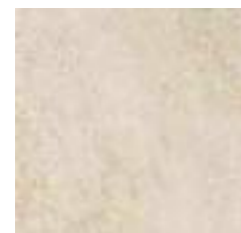

PIETRA DI FIRENZE ALBINO
30 x 30 (G 25) 11,8" x 11,8" m²

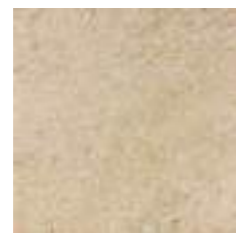

PIETRA DI FIRENZE NOCCIOLA
30 x 30 (G 25) 11,8" x 11,8" m²

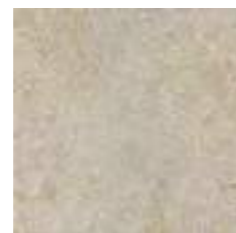

PIETRA DI FIRENZE GIADA
30 x 30 (G 25) 11,8" x 11,8" m²

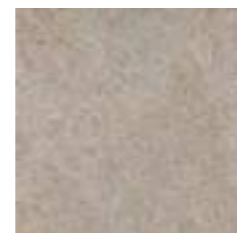

PIETRA DI FIRENZE NEBBIA
30 x 30 (G 25) 11,8" x 11,8" m²

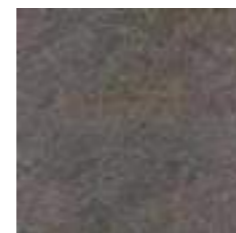

PIETRA DI FIRENZE NERO
30 x 30 (G 25) 11,8" x 11,8" m²

PACKING BASES

FORMATO	PULGADAS	PZ/CAJA	M ²	CAJA/PLT	PESO/CAJA	PESO/PLT
30 x 60	11,8" x 23,6"	6	1,08	48	24,82	1.205
30 x 30	11,8" x 11,8"	11	1	72	20,27	1474
ENM. 30 x 30	11,8" x 11,8"	11	1	72	18,36	1.336

PACKING PIEZAS ESPECIALES

FORMATO	PULGADAS	PZ/CAJA	ML	CAJA/PLT	PESO/CAJA	PESO/PLT
ANG. PELD. 33 x 46/4	13" x 18"	2	0,33	90	3,46	325
PELD. CURVO 30 x 33/4	11,8" x 13"	4	1,2	54	11,94	660
PASAMANOS 18 x 30/4	7" x 11,8"	8	2,4	64	15,38	1.000
VIERTEAGUAS 15 x 30/4	5,9" x 11,8"	14	4,2	36	19,84	729
ZANQUÍN 9 x 30	3,5" x 11,8"	30	9	56	16,24	924
ZÓCALO 9 x 30	3,5" x 11,8"	30	9	56	19,6	1.112

ENMALLADOS · ON A MESH

Disponible en todos los colores · Available in all colors



ENMALLADO PIETRA DI FIRENZE
30 x 30 (G 17) 11,8" x 11,8" m²

PIEZAS ESPECIALES · SPECIAL PIECES

Disponible en todos los colores · Available in all colors



PELDAÑO CURVO
30 x 33/4 (G 17) 11,8" x 13"



ÁNGULO PELDAÑO
33 x 46/4 (G 19 x 2PZ) 13" x 18"

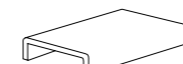

PASAMANOS
18 x 30/4 (G 30) 7" x 11,8"

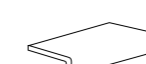

VIERTEAGUAS
15 x 30/4 (G 12) 5,9" x 11,8"

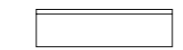

ZÓCALO
9 x 30 (G 06) 3,5" x 11,8"

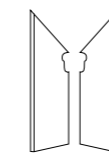

ZANQUÍN · IZQ. / DCHA.
9 x 30 (G 10) 3,5" x 11,8"

Consultar disponibilidad
Check availability



RESISTE LA FLEXIÓN	RESISTE EL DESGASTE	RESISTE EL RAYADO	ANTIDESLIZANTE	ANTI.TORUS	MANCHAS	ABSORCIÓN	DILATACIÓN	
28 N/mm2	PEI (III - IV)	MOHS - 9	Class III - R12	0,85 - 0,78	Class 5 - Class A	0,1%	6° 10° / °C	EXTERIOR - R12
34 N/mm2	PEI (III - IV)	MOHS - 9	Class II	0,55 - 0,27	Class 5 - Class A	0,1%	6,7° 10° / °C	Comfort floor

EXTERIOR - R12

GRES EXTRUS. PORCELÁNICO PORCELAIN EXTRUDED TILE	PAV. DE EXTERIOR OUTDOOR FLOOR TILE	MODULARIDAD MODULARITY	SUPERFICIE SEMIBRILLO SURFACE SEMI-GLOSS	RES. A ÁCIDOS Y BASES RES. TO ACIDS & BASES	RES. A LA HELADA FROST PROOF	DESTONIF. ARMONIOSO CONTROLLED DESTONIF.	SIN MANTENIMIENTO NO MAINTENANCE

Comfort floor

GRES EXTRUS. PORCELÁNICO PORCELAIN EXTRUDED TILE	PAV. DE EXTERIOR OUTDOOR FLOOR TILE	PAV. DE INTERIOR INDOOR FLOOR TILE	SUPERFICIE BRILLO SURFACE BRIGHTNESS	RES. A ÁCIDOS Y BASES RES. TO ACIDS & BASES	RES. A LA HELADA FROST PROOF	DESTONIF. ARMONIOSO CONTROLLED DESTONIF.	SIN MANTENIMIENTO NO MAINTENANCE

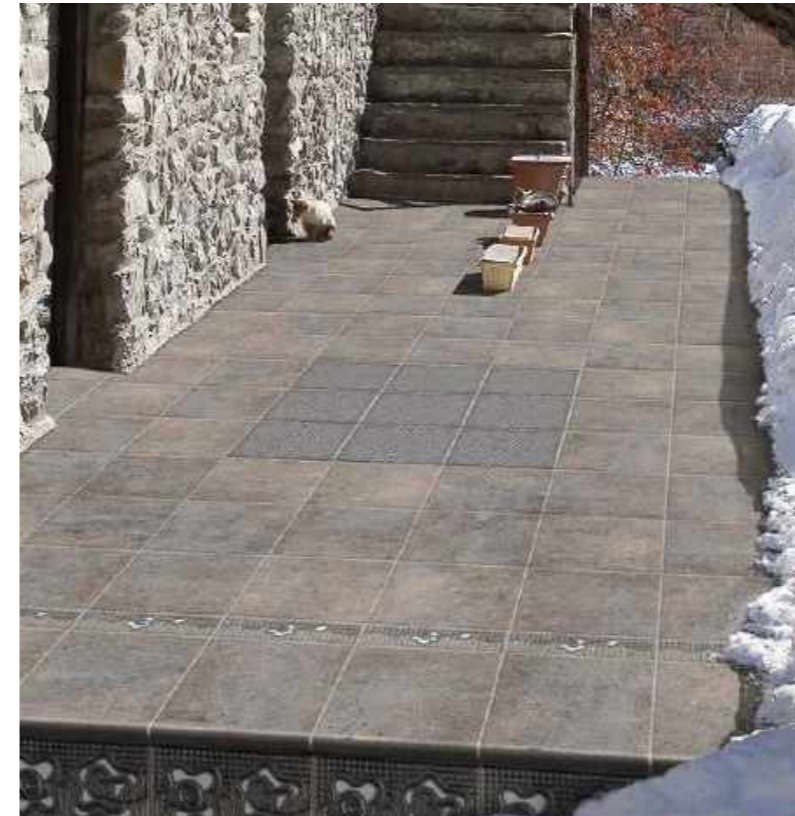

COLORES · COLORS

Comfort floor ▶ Class II

PIEZAS ESPECIALES · SPECIAL PIECES
Disponible en todos los colores
Available in all colors



ROCAS DE GALICIA VERIN 30 x 60 (G 56) 11,8" x 23,6" m²
ROCAS DE GALICIA NOYA 30 x 60 (G 56) 11,8" x 23,6" m²
ROCAS DE GALICIA TUI 30 x 60 (G 56) 11,8" x 23,6" m²
ROCAS DE GALICIA SADA 30 x 60 (G 56) 11,8" x 23,6" m²
ROCAS DE GALICIA BURELA 30 x 60 (G 56) 11,8" x 23,6" m²



ROCAS DE GALICIA VERIN 30 x 30 (G 25) 11,8" x 11,8" m²
ROCAS DE GALICIA NOYA 30 x 30 (G 25) 11,8" x 11,8" m²
ROCAS DE GALICIA TUI 30 x 30 (G 25) 11,8" x 11,8" m²
ROCAS DE GALICIA SADA 30 x 30 (G 25) 11,8" x 11,8" m²
ROCAS DE GALICIA BURELA 30 x 30 (G 25) 11,8" x 11,8" m²

EXTERIOR - R12 Comfort floor



PELDAÑO CURVO
30 x 33/4 (G 17) 11,8" x 13" ◆

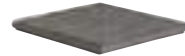

ÁNGULO PELDAÑO
33 x 46/4 (G 18 x 2PZ) 13" x 18" ◆



ZANQUÍN · IZQ. / DRCH.
9 x 30 (G 10) 3,5" x 11,8" ◆



ZÓCALO
9 x 30 (G 06) 3,5" x 11,8" ◆

COLORES · COLORS

EXTERIOR ▶ R12 - Class III

PIEZAS ESPECIALES · SPECIAL PIECES
Disponible en todos los colores
Available in all colors



ROCAS DE GALICIA ORENSE 30 x 60 (G 56) 11,8" x 23,6" m²
ROCAS DE GALICIA SANTIAGO 30 x 60 (G 56) 11,8" x 23,6" m²
ROCAS DE GALICIA PONTEVEDRA 30 x 60 (G 56) 11,8" x 23,6" m²
ROCAS DE GALICIA LA CORUÑA 30 x 60 (G 56) 11,8" x 23,6" m²
ROCAS DE GALICIA LUGO 30 x 60 (G 56) 11,8" x 23,6" m²



ROCAS DE GALICIA ORENSE 30 x 30 (G 25) 11,8" x 11,8" m²
ROCAS DE GALICIA SANTIAGO 30 x 30 (G 25) 11,8" x 11,8" m²
ROCAS DE GALICIA PONTEVEDRA 30 x 30 (G 25) 11,8" x 11,8" m²
ROCAS DE GALICIA LA CORUÑA 30 x 30 (G 25) 11,8" x 11,8" m²
ROCAS DE GALICIA LUGO 30 x 30 (G 25) 11,8" x 11,8" m²

EXTERIOR - R12 SE FABRICA EN CLASE III

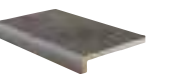

VIERTEAGUAS
15 x 30/4 (G 12) 5,9" x 11,8" ◆

PACKING BASES

FORMATO	PULGADAS	PZ/CAJA	M ²	CAJA/PLT	PESO/CAJA	PESO/PLT
30 x 60	11,8" x 23,6"	6	1,08	48	24,82	1.205
30 x 30	11,8" x 11,8"	11	1	72	20,27	1474

PACKING BASES

FORMATO	PULGADAS	PZ/CAJA	M ²	CAJA/PLT	PESO/CAJA	PESO/PLT
15 x 30	5,9" x 11,8"	22	1	60	22,32	1.353
15 x 15	5,9" x 5,9"	44	1	60	22,51	1.358

PACKING PIEZAS ESPECIALES

FORMATO	PULGADAS	PZ/CAJA	ML	CAJA/PLT	PESO/CAJA	PESO/PLT
PELD. CURVO 30 x 33/4	11,8" x 13"	4	1,2	54	11,94	660
VIERTEAGUAS 15 x 30/4	5,9" x 11,8"	14	4,2	36	19,84	729
ÁNGULO PELD. 33 x 46/4	13" x 18"	2	0,33	90	3,46	325

PACKING PIEZAS ESPECIALES

FORMATO	PULGADAS	PZ/CAJA	ML	CAJA/PLT	PESO/CAJA	PESO/PLT
ZÓCALO 9 x 30	3,5" x 11,8"	30	9	56	19,6	1.112
ZANQUÍN 9 x 30	3,5" x 11,8"	30	9	56	16,24	924

FUERZA DE ROTURA	RESISTE LA FLEXIÓN	RESISTE EL DESGASTE	RESISTE EL RAYADO	ANTIDESLIZANTE	ANTI-TORUS	MANCHAS	ABSORCIÓN	DILATACIÓN	
3306 Nw	30 N/mm2	PEI (III - IV)	MOHS - 9	Class III - R12	0,93 - 0,85	Class 5 - Class A	0,1%	6,6° 10° / °C	GROSSO 14,2mm.
2380 Nw	31 N/mm2	PEI (III - IV)	MOHS - 9	Class III - R12	0,93 - 0,85	Class 5 - Class A	0,2%	6,6° 10° / °C	FINE 10mm.

GRES EXTRUS. PORCELÁNICO PORCELAIN EXTRUDED TILE	PAV. DE EXTERIOR OUTDOOR FLOOR TILE	PAV. DE INTERIOR INDOOR FLOOR TILE	SUPERFICIE SEMIBRILLO SURFACE SEMI-GLOSS	SIN MANTENIMIENTO NO MAINTENANCE	RES. A ÁCIDOS Y BASES RES. TO ACIDS AND BASES	RES. A LA HELADA FROST PROOF	DESTONIFICADO ARMÓNICO CONTROLLED DESTONIFICATION



PIEZAS ESPECIALES · SPECIAL PIECES

Disponible en todos los colores · Available in all colors

ZÓCALO 9 x 30 (G 06) 3,5" x 11,8" 9 x 25 (G 05) 3,5" x 10"	PELDAÑO CURVO 25 x 33/4 (G 16) 10" x 13"	ÁNGULO PELDAÑO CURVO 33 x 46/4 (G 18 x 2PZ) 13" x 18"	VIERTHEADAS 15 x 30/4 (G 12) 5,9" x 11,8" 15 x 25/4 (G 10) 5,9" x 10"
ZANQUÍN - IZQ. / DRCH. 9 x 30 (G 10) 3,5" x 11,8" PARA PELDAÑO CURVO	PELDAÑO ANGULAR 30 x 33/4 (G 17) 11,8" x 13"	ÁNGULO PELDAÑO ANGULAR 32 x 46 / 4 (G 18 X 2PZ) 13" x 18"	PASAMANOS 18 x 30/4 (G 30) 7" x 11,8" 18 x 25/4 (G 13) 7" x 10" Consultar disponibilidad Check availability
ZANQUÍN - IZQ. / DRCH. 9 x 30 (G 10) 3,5" x 11,8" PARA PELDAÑO ANGULAR	CUBRECANTO 4 x 30 x 4 (G 13) 1,5" x 11,8" x 1,5"	COMP. EXT. CUBRECANTO 4 x 4 (G 17) 1,5" x 1,5"	COMP. INT. CUBRECANTO 4 x 4 (G 17) 1,5" x 1,5"
ZANQUÍN - IZQ. / DRCH. 9 x 30 (G 10) 3,5" x 11,8" PARA PELDAÑO ANGULAR	MEDIA CAÑA INTERIOR 4 x 30 x 4 (G 12) 1,5" x 11,8" x 1,5"	COMP. INT. MEDIA CAÑA 4 x 4 (G 17) 1,5" x 1,5"	COMP. EXT. MEDIA CAÑA 4 x 4 (G 17) 1,5" x 1,5"
ZÓCALO ANGULAR 9,5 x 30 x 4 (G 16) 4" x 11,8" x 1,5"	ESQUINA INT. ZÓCALO ANGULAR 9,5 x 4 (G 17) 4" x 1,5"	ESQUINA EXT. ZÓCALO ANGULAR 9,5 x 4 (G 17) 4" x 1,5"	

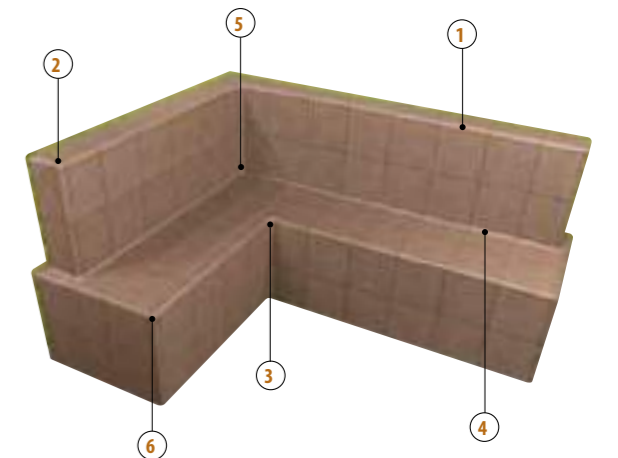

COLORES · COLORS

GROSSO ▶ R12 - Class III

QUARTZ KLINKER LATTEO HEX. 15 x 17 (G 46) 6" x 7" m²	QUARTZ KLINKER RUTILIO HEX. 15 x 17 (G 46) 6" x 7" m²	QUARTZ KLINKER CITRINO HEX. 15 x 17 (G 46) 6" x 7" m²	QUARTZ KLINKER FUME HEX. 15 x 17 (G 46) 6" x 7" m²	QUARTZ KLINKER GALENA HEX. 15 x 17 (G 46) 6" x 7" m²
QUARTZ KLINKER LATTEO 15 x 15 (G 39) 5,9" x 5,9" m²	QUARTZ KLINKER RUTILIO 15 x 15 (G 39) 5,9" x 5,9" m²	QUARTZ KLINKER CITRINO 15 x 15 (G 39) 5,9" x 5,9" m²	QUARTZ KLINKER FUME 15 x 15 (G 39) 5,9" x 5,9" m²	QUARTZ KLINKER GALENA 15 x 15 (G 39) 5,9" x 5,9" m²
QUARTZ KLINKER LATTEO 15 x 30 (G 38) 5,9" x 11,8" m²	QUARTZ KLINKER RUTILIO 15 x 30 (G 38) 5,9" x 11,8" m²	QUARTZ KLINKER CITRINO 15 x 30 (G 38) 5,9" x 11,8" m²	QUARTZ KLINKER FUME 15 x 30 (G 38) 5,9" x 11,8" m²	QUARTZ KLINKER GALENA 15 x 30 (G 38) 5,9" x 11,8" m²
QUARTZ KLINKER LATTEO 30 x 30 (G 38) 11,8" x 11,8" m²	QUARTZ KLINKER RUTILIO 30 x 30 (G 38) 11,8" x 11,8" m²	QUARTZ KLINKER CITRINO 30 x 30 (G 38) 11,8" x 11,8" m²	QUARTZ KLINKER FUME 30 x 30 (G 38) 11,8" x 11,8" m²	QUARTZ KLINKER GALENA 30 x 30 (G 38) 11,8" x 11,8" m²

COLORES · COLORS

FINE ▶ R12 - Class III

QUARTZ KLINKER LATTEO 30 x 60 (G 56) 11,8" x 23,6" m²	QUARTZ KLINKER RUTILIO 30 x 60 (G 56) 11,8" x 23,6" m²	QUARTZ KLINKER CITRINO 30 x 60 (G 56) 11,8" x 23,6" m²	QUARTZ KLINKER FUME 30 x 60 (G 56) 11,8" x 23,6" m²	QUARTZ KLINKER GALENA 30 x 60 (G 56) 11,8" x 23,6" m²
QUARTZ KLINKER LATTEO 25 x 25 (G 24) 10" x 10" m²	QUARTZ KLINKER RUTILIO 25 x 25 (G 24) 10" x 10" m²	QUARTZ KLINKER CITRINO 25 x 25 (G 24) 10" x 10" m²	QUARTZ KLINKER FUME 25 x 25 (G 24) 10" x 10" m²	QUARTZ KLINKER GALENA 25 x 25 (G 24) 10" x 10" m²

PACKING BASES

FORMATO	PULGADAS	PZ/CAJA	M²	CAJA/PLT	PESO/CAJA	PESO/PLT
GROSSO 30 x 30	11,8" x 11,8"	10	0,9	60	25	1.520
GROSSO 15 x 30	5,9" x 11,8"	20	0,9	54	25	1.369
GROSSO 15 x 15	5,9" x 5,9"	22	0,5	80	13,74	1.113
HEX. 15 x 17	6" x 7"	21	0,4	80	12,45	1.010
FINE 30 x 60	11,8" x 23,6"	6	1,08	48	24,82	1.205
FINE 25 x 25	10" x 10"	16	1	72	21,06	1.530

PACKING PIEZAS ESPECIALES

FORMATO	PULGADAS	PZ/CAJA	ML	CAJA/PLT	PESO/CAJA	PESO/PLT
ZÓCALO 9 x 30	3,5" x 11,8"	30	9	56	19,6	1.112
ZÓCALO 9 x 25	3,5" x 10"	40	10	48	24,1	1.171
ZANQUÍN 9 x 30	3,5" x 11,8"	30	9	56	16,24	924
PELD. CURVO 25 x 33/4	10" x 13"	6	1,5	54	13,48	743
PELD. ANG. 30 x 33/4	11,8" x 13"	4	1,2	54	11,94	660
ANG. PELD. ANG. 32 x 46/4	13" x 18"	2	0,32	90	3,46	308
ANG. PELD. CURV. 33 x 46/4	13" x 18"	2	0,33	90	3,46	325

PACKING PIEZAS ESPECIALES

FORMATO	PULGADAS	PZ/CAJA	ML	CAJA/PLT	PESO/CAJA	PESO/PLT
PASAMANOS 18 x 30/4	7" x 11,8"	8	2,4	64	15,38	1.000
PASAMANOS 18 x 25/4	7" x 10"	8	2	52	12,74	682
VIERTHEADAS 15 x 30/4	5,9" x 11,8"	14	4,2	36	19,84	729
VIERTHEADAS 15 x 25/4	5,9" x 10"	14	3,5	48	16,9	831
ZÓCALO ANG. 9,5 x 30 x 4	4" x 11,8" x 1,5"	10	3	50	8,5	440
ESQ. INT. ZOC. ANG. 9,5 x 4	4" x 1,5"	10	0,4	-	1,28	-
ESQ. EXT. ZOC. ANG. 9,5 x 4	4" x 1,5"	6	0,24	-	1,17	-

PACKING PIEZAS ESPECIALES

FORMATO	PULGADAS	PZ/CAJA	ML	CAJA/PLT	PESO/CAJA	PESO/PLT
CUBRECANTO 4 x 30 x 4	1,5" x 11,8" x 1,5"	26	7,8	-	7,33	-
COMP. EXT. CUBRE. 4 x 4	1,5" x 1,5"	25	0,83	-	0,55	-
COMP. INT. CUBRE. 4 x 4	1,5" x 1,5"	10	0,33	-	0,85	-
MEDIA CAÑA INT. 4 x 30 x 4	1,5" x 11,8" x 1,5"	22	6,6	-	9,91	-
COMP. EXT. MEDIA CA. 4 x 4	1,5" x 1,5"	18	0,6	-	1,34	-
COMP. INT. MEDIA CA. 4 x 4	1,5" x 1,5"	20	0,66	-	1,84	-

CUARCITA

fine **RESISTANCE**
R11 - Class III

EVOLUTION
EXTRUDED PORCELAIN TILE

in & out
INTERIOR - EXTERIOR

AntiSlip



FUERZA DE ROTURA
1143 Nw



CARGA DE ROTURA
1241 Nw



RESISTE LA FLEXIÓN
36 N/mm2



RESISTE EL DESGASTE
PEI (III)



RESISTE EL RAYADO
MOHS - 8



ANTIDESLIZANTE
Class III - R11



ANTID.TORUS
0,82 - 0,77



MANCHAS
Class 5
Class A



ABSORCIÓN
0,1%



DILATACIÓN
5,7* 10⁻⁴ / °C

PE GRES EXTRUSIONADO PORCELÁNICO
PORCELAIN EXTRUDED TILE

PAV. DE EXTERIOR
OUTDOOR FLOOR TILE

SUPERFICIE SEMIBRILLO
SURFACE SEMI-GLOSS

SIN MANTENIMIENTO
NO MAINTENANCE

RES. A ÁCIDOS Y BASES
RES. TO ACIDS AND BASES

RES. A LA HELADA
FROST PROOF

DESTONIFICADO ARMONIOSO
CONTROLLED DESTONIFICATION



COLORES · COLORS

fine **RESISTANCE** ▶ R11 - Class III



CUARCITA BEIGE
30 x 30 (G 22) 11,8" x 11,8" m²

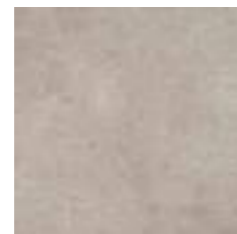

CUARCITA GRIS
30 x 30 (G 22) 11,8" x 11,8" m²



CUARCITA MARRÓN
30 x 30 (G 22) 11,8" x 11,8" m²

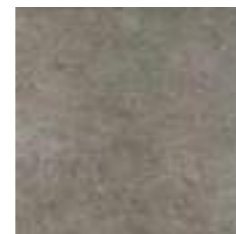

CUARCITA ANTRACITA
30 x 30 (G 22) 11,8" x 11,8" m²

PIEZAS ESPECIALES · SPECIAL PIECES

Disponibles en todos los colores · Available in all colors



PELDAÑO CURVO
30 x 33/4 (G 17) 11,8" x 13"



ÁNGULO PELDAÑO
33 x 46/4 (G 18 x 2PZ) 13" x 18"

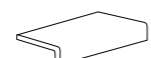

VIERTEAGUAS
15 x 30/4 (G 12) 6" x 11,8"



ZÓCALO
9 x 30 (G 06) 3,5" x 11,8"

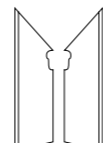

ZANQUÍN · IZQ. / DCHA.
9 x 30 (G 10) 3,5" x 11,8"

PACKING BASES

FORMATO	PULGADAS	PZ/CAJA	M ²	CAJA/PLT	PESO/CAJA	PESO/PLT
30 x 30	11,8" x 11,8"	15	1,35	72	22,24	1615

PACKING PIEZAS ESPECIALES

FORMATO	PULGADAS	PZ/CAJA	ML	CAJA/PLT	PESO/CAJA	PESO/PLT
PELD. CURVO 30 x 33/4	11,8" x 13"	4	1,2	54	11,94	660
VIERTEAGUAS 15 x 30/4	6" x 11,8"	14	4,2	36	17,6	648
ÁNGULO PELD. 33 x 46/4	13" x 18"	2	0,33	90	3,46	325
ZÓCALO 9 x 30	3,5" x 11,8"	30	9	56	19,6	1.112
ZANQUÍN 9 x 30	3,5" x 11,8"	30	9	56	16,24	924



TECH·LAND

fine **RESISTANCE**
EVOLUTIO
 EXTRUDED PORCELAIN TILE
 CLASE III-R11
 SOFT

in & out
 INTERIOR - EXTERIOR
ANTI-BACTERIAL

14 mm
 ESPESOR
 THICKNESS

PE GRES EXTR. PORCELÁNICO
 PORCELAIN EXTRUDED TILE
PAV. DE INTERIOR
 INDOOR FLOOR TILE
PAVIMENTO DE EXTERIOR
 OUTDOOR FLOOR TILE

SUPERFICIE MATE
 MATT SURFACE
SIN MANTENIMIENTO
 NO MAINTENANCE
DESTONIFICADO ARMONIOSO
 CONTROLLED DESTONIFICATION

RESIST. A LA HELADA
 FROST PROOF
RESIST. A ÁCIDOS Y BASES
 RESIST. TO ACIDS & BASES

FUERZA DE ROTURA
 3119 Nw
CARGA DE ROTURA
 3408 Nw
RESISTE LA FLEXIÓN
 28 N/mm2
RESISTE EL DESGASTE
 PEI (II-III)
RESISTE EL RAYADO
 MOHS - 8
ANTIDESLIZANTE
 Clase III - R11
ANTID. DCOF.
 0,69
ANTID. DIN 51097
 Clase C > 37°
MANCHAS
 Class 5 - Class A
ABSORCIÓN
 0,3%
DILATACIÓN
 6,6" 10"/°C
ANTIBACTERIANO
 Norma IIS 2 2801

FORMATOS
 11 x 22,5 - 4,3" x 8,8"
 22,5 x 22,5 - 8,8" x 8,8"
 22,5 x 33 - 8,8" x 13"
 30 x 30 - 11,8" x 11,8"
 7 x 60 - 3" x 23,6"
ARROW 7 x 33,5 - 3" x 13,1"
HEX. 18 x 20,5 - 7" x 8"
 15,5 x 15,5 - 6" x 6"



TECH LAND FIRE



DECORADOS · DECORATION

EVOLUTIO
 EXTRUDED PORCELAIN TILE
PINTADO A MANO



DECORACIÓN · DECORATION

Decoración serie TECH LAND completa en pág. 78-81
 Complete TECH LAND decor on pág. 78-81

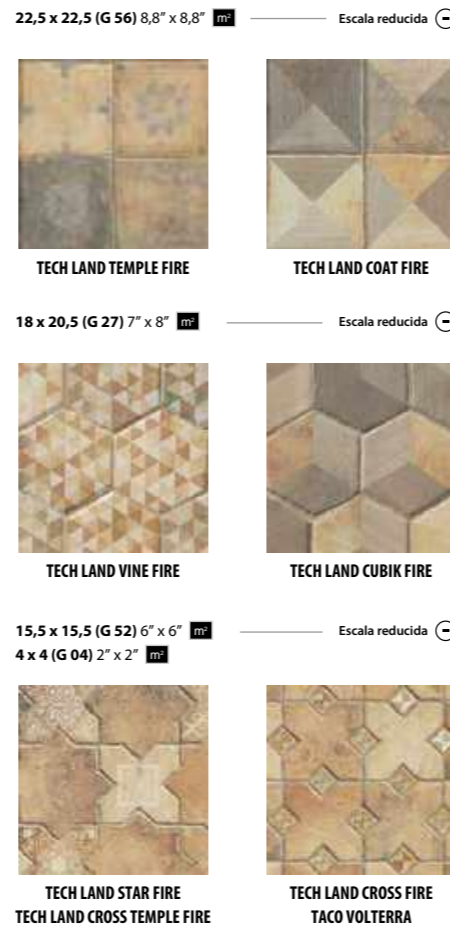

TECH LAND NATURAL



DECORACIÓN · DECORATION

Decoración serie TECH LAND completa en pág. 82-83
 Complete TECH LAND decor on pág. 82-83



PACKING DECORADO

FORMATO	PULGADAS	PZ/CAJA	M ²	CAJA/PLT	PESO/CAJA	PESO/PLT
TACO 6,5 x 6,5	3" x 3"	60	3,9	60	5,02	-
TACO 4 x 4	2" x 2"	50	2	60	2,1	-

PACKING BASES

FORMATO	PULGADAS	PZ/CAJA	M ²	CAJA/PLT	PESO/CAJA	PESO/PLT
7 x 60	3" x 23,6"	18	0,76	66	21,96	1.464
STAR 15,5 x 15,5	6" x 6"	12	0,34	96	9,9	966
CROSS 15,5 x 15,5	6" x 6"	18	0,44	105	10,40	1.107

PACKING BASES

FORMATO	PULGADAS	PZ/CAJA	M ²	CAJA/PLT	PESO/CAJA	PESO/PLT
30 x 30	11,8" x 11,8"	10	0,90	60	25	1.520
ARROW 7 x 33,5	3" x 13,1"	36	0,85	48	23,68	1.152
HEX. 18 x 20,5	7" x 8"	30	0,83	48	22,57	1.098

PACKING BASES

FORMATO	PULGADAS	PZ/CAJA	M ²	CAJA/PLT	PESO/CAJA	PESO/PLT
22,5 x 33	8,8" x 13"	11	0,82	68	23,3	1.600
22,5 x 22,5	8,8" x 8,8"	17	0,86	60	23,19	1.406
11 x 22,5	4,3" x 8,8"	20	0,5	112	13,70	1.550



COLORES · COLORS

fine RESISTANCE ▶ R11 - Class III

PIEZAS ESPECIALES · SPECIAL PIECES

Disponible en todos los colores · Available in all colors



ÁNGULO PELDAÑO CURVO 1PZ.
33 x 33/4 (G 56) 13\"/>



PELDAÑO CURVO
22,5 x 33/4 (G 16) 8,8\"/>

PIEZAS ESPECIALES · SPECIAL PIECES

Disponible en BIANCO y AZURRO · Available in BIANCO & AZURRO



PELDAÑO ANGULAR
120 x 32/2,5 (G 42) 48\"/>



REMATE PELDAÑO ANGULAR - IZQ. / DRCH.
2,5 x 32 (G 15) 1\"/>

COLORES DISPONIBLES:
Remate Peldaño Angular CAVA combinable con BIANCO
Remate Peldaño Angular MOKA combinable con AZURRO

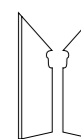

ZANQUÍN 2,5 A - IZQ. / DRCH.
9 x 30 (G 11) 3,5\"/>

DECORACIÓN · DECORATION

Decoración serie D'ANTICATTO completa en pág. 94-95 · Complete D'ANTICATTO decor on pág. 94-95

22,5 x 22,5 (G 57) 8,8\"/>

MIX VARESE	FLORENCE	VARENNA	LATERZA	TRIANGOLI	OBLIQUA	QUADRATI

PACKING BASES

FORMATO	PULGADAS	PZ/CAJA	M ²	CAJA/PLT	PESO/CAJA	PESO/PLT
22,5 x 45	8,8\"/>	10	1,01	72	21,1	1.530
22,5 x 22,5	8,8\"/>	20	1,01	72	20,7	1.505
11 x 22,5	4,3\"/>	20	0,5	144	10,4	1.513

PACKING PIEZAS ESPECIALES

FORMATO	PULGADAS	PZ/CAJA	ML	CAJA/PLT	PESO/CAJA	PESO/PLT
ÁNG. PELD. 1PZ. 33x33/4	13\"/>	1	0,33	90	3,7	333
PELDAÑO CUR. 22,5x33/4	8,8\"/>	6	13,5	64	12	783
PELDAÑO ANG. 120 x 32/2,5	48\"/>	2	2,4	14	36,7	530,2
PELDAÑO ANG. 60 x 32/2,5	23,6\"/>	2	1,2	28	18,75	542,8

PACKING PIEZAS ESPECIALES

FORMATO	PULGADAS	PZ/CAJA	ML	CAJA/PLT	PESO/CAJA	PESO/PLT
ZANQUÍN 2,5 A 9x30	3,5\"/>	30	9	48	19,5	955,8
REMATE PELDAÑO 2,5x32	1\"/>	20	6,4	60	3,4	219
MEDIA CAÑA INT. 4 x 30 x 4	1,5\"/>	22	6,6		9,91	
COMP. EXT. M. CAÑA 4 x 4	1,5\"/>	18	0,6		1,34	

PACKING PIEZAS ESPECIALES

FORMATO	PULGADAS	PZ/CAJA	ML	CAJA/PLT	PESO/CAJA	PESO/PLT
COMP. INT. M. CAÑA 4 x 4	1,5\"/>	20	0,66		1,84	
CUBRECANTO 4 x 30 x 4	1,5\"/>	26	7,8		7,33	
COMP. EXT. CUBREC. 4 x 4	1,5\"/>	25	0,83		0,55	
COMP. INT. CUBREC. 4 x 4	1,5\"/>	10	0,33		0,85	



COLORES · COLORS



D'ANTICATTO BIANCO
CHEVRON IZQ./DCHA.
14 x 32,5 (G 39) 6" x 12,7" m²



D'ANTICATTO MARRONE
CHEVRON IZQ./DCHA.
14 x 32,5 (G 39) 6" x 12,7" m²



D'ANTICATTO GRIGIO
CHEVRON IZQ./DCHA.
14 x 32,5 (G 39) 6" x 12,7" m²



D'ANTICATTO AZURRO
CHEVRON IZQ./DCHA.
14 x 32,5 (G 39) 6" x 12,7" m²



D'ANTICATTO MUSCHIO
CHEVRON IZQ./DCHA.
14 x 32,5 (G 39) 6" x 12,7" m²



D'ANTICATTO NOTTE
CHEVRON IZQ./DCHA.
14 x 32,5 (G 39) 6" x 12,7" m²

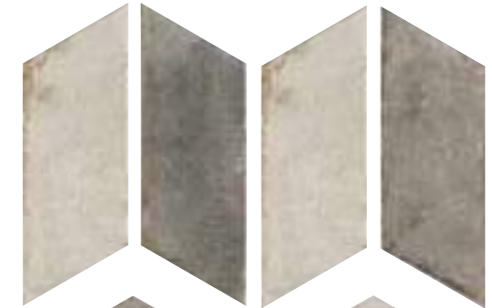

D'ANTICATTO MIX
CHEVRON IZQ./DCHA.
14 x 32,5 (G 39) 6" x 12,7" m²
Se suministra mezclado por
BIANCO · GRIGIO · NOTTE



D'ANTICATTO BIANCO
HEX. 28,5 x 32,5 (G 56)
11,2" x 12,7" m²



D'ANTICATTO MARRONE
HEX. 28,5 x 32,5 (G 56)
11,2" x 12,7" m²



D'ANTICATTO GRIGIO
HEX. 28,5 x 32,5 (G 56)
11,2" x 12,7" m²



D'ANTICATTO AZURRO
HEX. 28,5 x 32,5 (G 56)
11,2" x 12,7" m²

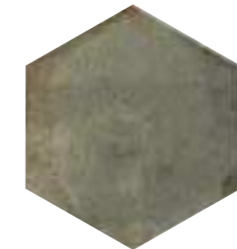

D'ANTICATTO MUSCHIO
HEX. 28,5 x 32,5 (G 56)
11,2" x 12,7" m²

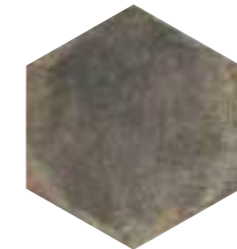

D'ANTICATTO NOTTE
HEX. 28,5 x 32,5 (G 56)
11,2" x 12,7" m²



D'ANTICATTO MIX
HEX. 28,5 x 32,5 (G 56)
11,2" x 12,7" m²
Se suministra mezclado por
BIANCO · GRIGIO · NOTTE



D'ANTICATTO BIANCO
7 x 45 (G 27) 3" x 17,7" m²



D'ANTICATTO MARRONE
7 x 45 (G 27) 3" x 17,7" m²



D'ANTICATTO GRIGIO
7 x 45 (G 27) 3" x 17,7" m²



D'ANTICATTO AZURRO
7 x 45 (G 27) 3" x 17,7" m²



D'ANTICATTO MUSCHIO
7 x 45 (G 27) 3" x 17,7" m²



D'ANTICATTO NOTTE
7 x 45 (G 27) 3" x 17,7" m²



D'ANTICATTO MIX
7 x 45 (G 27) 3" x 17,7" m²
Se suministra mezclado por
BIANCO · GRIGIO · NOTTE

PACKING BASES

FORMATO	PULGADAS	PZ/CAJA	M ²	CAJA/PLT	PESO/CAJA	PESO/PLT
HEX. 28,5 x 32,5	11,2" x 12,7"	15	1,05	48	21,9	1.063
CHEVRON 14 x 32,5	6" x 12,7"	21	0,96	72	21,46	1.560
7 x 45	3" x 17,7"	32	1	60	21,40	1.300

PACKING PIEZAS ESPECIALES

FORMATO	PULGADAS	PZ/CAJA	ML	CAJA/PLT	PESO/CAJA	PESO/PLT
ZÓCALO 9 x 30	3,5" x 11,8"	30	9	48	19,7	960
ZANQUÍN 9 x 30	3,5" x 11,8"	30	9	48	16,24	794

RESISTE LA FLEXIÓN 37 N/mm2	RESISTE EL DESGASTE PEI (III - IV)	RESISTE EL RAYADO MOHS - 9	ANTIDESLIZANTE Class III - R11	ANTID.TORUS 0,82 - 0,76	MANCHAS Class 5 - Class A	ABSORCIÓN 0,1%	DILATACIÓN 6,4° 10° / °C
--------------------------------	---------------------------------------	-------------------------------	-----------------------------------	----------------------------	------------------------------	-------------------	-----------------------------

GRES EXTRUSIONADO PORCELÁNICO PORCELAIN EXTRUDED TILE	SUPERFICIE MATE MATT SURFACE	PAV. DE EXTERIOR OUTDOOR FLOOR TILE	SIN MANTENIMIENTO NO MAINTENANCE	RES. A ÁCIDOS Y BASES RES. TO ACIDS AND BASES	RES. A LA HELADA FROST PROOF	DESTONIFICADO ARMONIOSO CONTROLLED DESTONIFICATION
--	---------------------------------	--	-------------------------------------	--	---------------------------------	---



FERRO DI BOSTON BIANCO



FERRO DI BOSTON CREMA

COLORES · COLORS



FERRO DI BOSTON BIANCO
15 x 30 (G 25) 5,9" x 11,8" m



FERRO DI BOSTON CREMA
15 x 30 (G 25) 5,9" x 11,8" m



FERRO DI BOSTON ROSSO
15 x 30 (G 25) 5,9" x 11,8" m



FERRO DI BOSTON OMBRA
15 x 30 (G 25) 5,9" x 11,8" m



FERRO DI BOSTON BIANCO
HEX. 36 x 41,5 (G 58) 14" x 16,2" m



FERRO DI BOSTON CREMA
HEX. 36 x 41,5 (G 58) 14" x 16,2" m

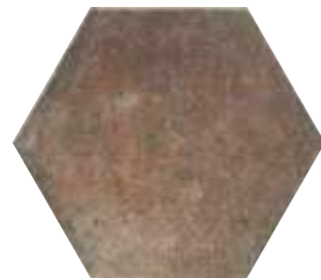

FERRO DI BOSTON ROSSO
HEX. 36 x 41,5 (G 58) 14" x 16,2" m



FERRO DI BOSTON OMBRA
HEX. 36 x 41,5 (G 58) 14" x 16,2" m



FERRO DI BOSTON BIANCO
NAVETA 18,5 x 42 (G 39) 7" x 16,4" m



FERRO DI BOSTON CREMA
NAVETA 18,5 x 42 (G 39) 7" x 16,4" m



FERRO DI BOSTON ROSSO
NAVETA 18,5 x 42 (G 39) 7" x 16,4" m



FERRO DI BOSTON OMBRA
NAVETA 18,5 x 42 (G 39) 7" x 16,4" m



FERRO DI BOSTON BIANCO
36 x 36 (G 57) 14" x 14" m



FERRO DI BOSTON CREMA
36 x 36 (G 57) 14" x 14" m



FERRO DI BOSTON ROSSO
36 x 36 (G 57) 14" x 14" m



FERRO DI BOSTON OMBRA
36 x 36 (G 57) 14" x 14" m

PIEZAS ESPECIALES · SPECIAL PIECES

Disponible en CREMA, ROSSO y OMBRA
Available in CREMA, ROSSO & OMBRA



PELDAÑO CURVO
120 x 32/2,5 (G 42) 48" x 12,5"/1"
60 x 32/2,5 (G 57) 23,6" x 12,5"/1"

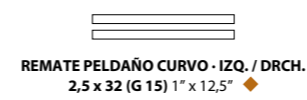

REMATE PELDAÑO CURVO - IZQ. / DRCH.
2,5 x 32 (G 15) 1" x 12,5"

COLORES DISPONIBLES:

Remate Peldaño Curvo PIMIENTA combinable con OMBRA
Remate Peldaño Curvo MOKA combinable con ROSSO y CREMA

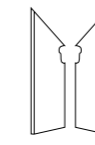

ZANQUÍN 2,5 C · IZQ. / DRCH.
9 x 36 (G 11) 3,5" x 14"

PIEZAS ESPECIALES · SPECIAL PIECES

Disponible en todos los colores · Available in all colors

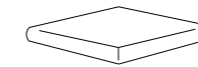

ÁNGULO PELDAÑO CURVO 1PZ.
33 x 33/4 (G 56) 13" x 13"

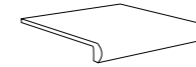

PELDAÑO CURVO
36 x 33/4 (G 18) 14" x 13"

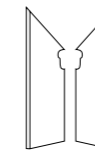

ZANQUÍN · IZQ. / DCHA.
9 x 36 (G 10) 3,5" x 14"

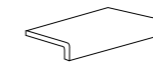

VIERTEAGUAS
15 x 30/4 (G 12) 5,9" x 11,8"

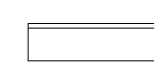

ZÓCALO
9 x 36 (G 07) 3,5" x 14"



FERRO DI BOSTON ROSSO



FERRO DI BOSTON OMBRA

PACKING PIEZAS ESPECIALES

FORMATO	PULGADAS	PZ/CAJA	ML	CAJA/PLT	PESO/CAJA	PESO/PLT
ÁNG. PELD. 1PZ. 33 x 33/4	13" x 13"	1	0,33	90	3,7	333
PELDAÑO CUR. 36 x 33/4	14" x 13"	4	1,44	54	13,36	736
VIERTEAGUAS 15 x 30/4	5,9" x 11,8"	14	4,20	48	15,08	738
ZÓCALO 9 x 36	3,5" x 14"	30	10,8	56	22,5	1.275
ZANQUÍN 9 x 36	3,5" x 14"	30	10,8	56	20	1.135
PELDAÑO CURV. 120 x 32/2,5	48" x 12,5"/1"	2	2,4	14	36,7	530
PELDAÑO CURV. 60 x 32/2,5	23,6" x 12,5"/1"	2	1,2	28	18,9	542
ZANQUÍN 2,5 C 9 x 36	3,5" x 14"	30	10,8	48	20	970
REMATE PELDAÑO 2,5 x 32	1" x 12,5"	20	6,4	60	3,5	219

PACKING BASES

FORMATO	PULGADAS	PZ/CAJA	M²	CAJA/PLT	PESO/CAJA	PESO/PLT
36 x 36	14" x 14"	8	1	48	20,6	1005
HEX. 36 x 41,5	14" x 16,2"	9	1	48	22,6	1.103
15 x 30	5,9" x 11,8"	22	1	60	22,32	1.353
NAVETA 18,5 x 42	7" x 16,4"	13	1,01	64	19,93	1.289

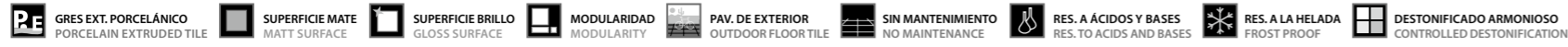

COLORES · COLORS



BOSTON DOWNTOWN
11 x 22,5 (G 57) 4,3" x 8,8" m²



BOSTON EAST
11 x 22,5 (G 57) 4,3" x 8,8" m²



BOSTON NORTH
11 x 22,5 (G 57) 4,3" x 8,8" m²



BOSTON SOUTH
11 x 22,5 (G 57) 4,3" x 8,8" m²



BOSTON WEST
11 x 22,5 (G 57) 4,3" x 8,8" m²



BOSTON DOWNTOWN
22,5 x 22,5 (G 25) 8,8" x 8,8" m²



BOSTON EAST
22,5 x 22,5 (G 25) 8,8" x 8,8" m²



BOSTON NORTH
22,5 x 22,5 (G 25) 8,8" x 8,8" m²



BOSTON SOUTH
22,5 x 22,5 (G 25) 8,8" x 8,8" m²



BOSTON WEST
22,5 x 22,5 (G 25) 8,8" x 8,8" m²



BOSTON DOWNTOWN
22,5 x 45 (G 25) 8,8" x 17,7" m²



BOSTON EAST
22,5 x 45 (G 25) 8,8" x 17,7" m²



BOSTON NORTH
22,5 x 45 (G 25) 8,8" x 17,7" m²



BOSTON SOUTH
22,5 x 45 (G 25) 8,8" x 17,7" m²



BOSTON WEST
22,5 x 45 (G 25) 8,8" x 17,7" m²

DECORACIÓN · DECORATION Decor AMERICAN completa en pág. 96-97 · Complete AMERICAN decor on pág. 96-97



MELROSE



NEWTON



CLEVELAND



HARVARD

PACKING BASES

FORMATO	PULGADAS	PZ/CAJA	M ²	CAJA/PLT	PESO/CAJA	PESO/PLT
11 x 22,5	4,3" x 8,8"	20	0,5	144	10,4	1.513
22,5 x 22,5	8,8" x 8,8"	20	1,01	72	20,7	1.505
22,5 x 45	8,8" x 17,7"	10	1,01	72	21,1	1.530

PIEZAS ESPECIALES · SPECIAL PIECES Disponible en DOWNTOWN, EAST y NORTH Available in DOWNTOWN, EAST & NORTH



PELDAÑO CURVO
120 x 32/2,5 (G 42) 48" x 12,5"/1"
60 x 32/2,5 (G 57) 23,6" x 12,5"/1"

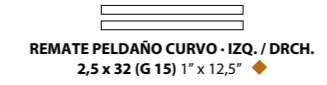

REMATE PELDAÑO CURVO - IZQ. / DRCH.
2,5 x 32 (G 15) 1" x 12,5"

COLORES DISPONIBLES:
Remate Peldaño Curvo CAVA combinable con DOWNTOWN
Remate Peldaño Curvo TABASCO combinable con NORTH
Remate Peldaño Curvo MALTA combinable con EAST

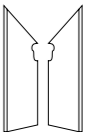

ZANQUÍN 2,5 C - IZQ. / DRCH.
9 x 36 (G 11) 3,5" x 14"

DECORACIÓN · DECORATION



FRONTAL COTTO
15,5 x 30 (G 12) 6" x 11,8"

PACKING DECORADO

FORMATO	PULGADAS	PZ/CAJA	ML	CAJA/PLT	PESO/CAJA	PESO/PLT
15,5 x 30	6" x 11,8"	15	4,5	56	14,9	850

PACKING PIEZAS ESPECIALES

FORMATO	PULGADAS	PZ/CAJA	ML	CAJA/PLT	PESO/CAJA	PESO/PLT
PELDAÑO CURV. 120 x 32/2,5	48" x 12,5"/1"	2	2,4	14	36,7	530
PELDAÑO CURV. 60 x 32/2,5	23,6" x 12,5"/1"	2	1,2	28	18,9	542
ZANQUÍN 2,5 9 x 36	3,5" x 14"	30	10,8	48	20	970
REMATE PELDAÑO 2,5 x 32	1" x 12,5"	20	6,4	60	3,5	219



RESISTE LA FLEXIÓN
37 N/mm2

RESISTE EL DESGASTE
PEI (III - IV)

RESISTE EL RAYADO
MOHS - 9

ANTIDESLIZANTE
Class III - R11

ANTID.TORUS
0,82 - 0,76

MANCHAS
Class 5 - Class A

ABSORCIÓN
0,1%

DILATACIÓN
6,4° 10⁴ / °C

- GRES EXTRUSIONADO PORCELÁNICO / PORCELAIN EXTRUDED TILE
- SUPERFICIE MATE / MATT SURFACE
- SUPERFICIE BRILLO / GLOSS SURFACE
- MODULARIDAD / MODULARITY
- PAV. DE EXTERIOR / OUTDOOR FLOOR TILE
- SIN MANTENIMIENTO / NO MAINTENANCE
- RES. A ÁCIDOS Y BASES / RES. TO ACIDS AND BASES
- RES. A LA HELADA / FROST PROOF
- DESTONIFICADO ARMONIOSO / CONTROLLED DESTONIFICATION



COLORES · COLORS



BOSTON DOWNTOWN
HEX. 28,5 x 32,5 (G 39) 11,2" x 12,7" m²



BOSTON EAST
HEX. 28,5 x 32,5 (G 39) 11,2" x 12,7" m²

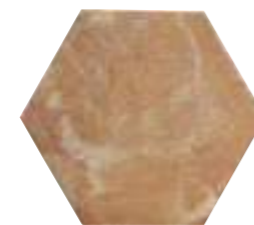

BOSTON NORTH
HEX. 28,5 x 32,5 (G 39) 11,2" x 12,7" m²



BOSTON SOUTH
HEX. 28,5 x 32,5 (G 39) 11,2" x 12,7" m²



BOSTON WEST
HEX. 28,5 x 32,5 (G 39) 11,2" x 12,7" m²



BOSTON DOWNTOWN
HEX. 36 x 41,5 (G 58) 14" x 16,2" m²



BOSTON EAST
HEX. 36 x 41,5 (G 58) 14" x 16,2" m²



BOSTON NORTH
HEX. 36 x 41,5 (G 58) 14" x 16,2" m²



BOSTON WEST
HEX. 36 x 41,5 (G 58) 14" x 16,2" m²



BOSTON DOWNTOWN
36 x 36 (G 57) 14" x 14" m²



BOSTON EAST
36 x 36 (G 57) 14" x 14" m²



BOSTON NORTH
36 x 36 (G 57) 14" x 14" m²



BOSTON SOUTH
36 x 36 (G 57) 14" x 14" m²



BOSTON WEST
36 x 36 (G 57) 14" x 14" m²

BOSTON COLORS

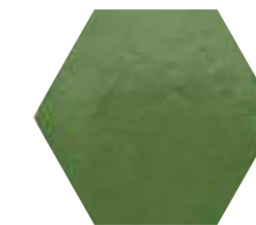

BOSTON GREEN HEX
28,5 x 32,5 (G 63) 11,2" x 12,7" m²

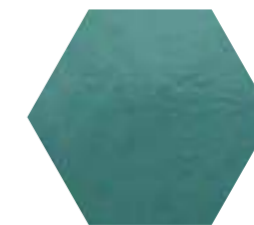

BOSTON TURQUOISE HEX
28,5 x 32,5 (G 63) 11,2" x 12,7" m²

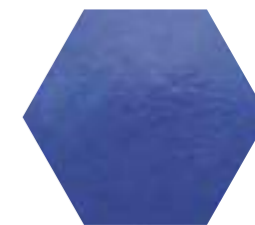

BOSTON BLUE HEX
28,5 x 32,5 (G 63) 11,2" x 12,7" m²

PIEZAS ESPECIALES · SPECIAL PIECES

Disponible en todos los colores · Available in all colors

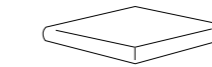

ÁNGULO PELDAÑO CURVO 1PZ.
33 x 33/4 (G 56) 13" x 13"

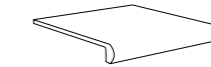

PELDAÑO CURVO
36 x 33/4 (G 18) 14" x 13"

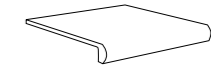

PELDAÑO CURVO
22,5 x 33/4 (G 16) 8,8" x 13"

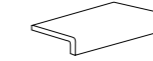

VIERTEAGUAS
15 x 22,5/4 (G 10) 5,9" x 8,8"

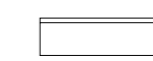

ZÓCALO
9 x 36 (G 07) 3,5" x 14"

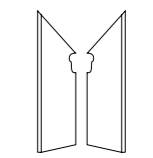

ZANQUÍN · IZQ. / DCHA.
9 x 36 (G 10) 3,5" x 14"

PACKING BASES

FORMATO	PULGADAS	PZ/CAJA	M ²	CAJA/PLT	PESO/CAJA	PESO/PLT
HEX. 28,5 x 32,5	11,2" x 12,7"	15	1,05	48	21,9	1.063
HEX. 36 x 41,5	14" x 16,2"	9	1	48	22,6	1.103
36 x 36	14" x 14"	8	1	48	22,04	1.072

PACKING PIEZAS ESPECIALES

FORMATO	PULGADAS	PZ/CAJA	ML	CAJA/PLT	PESO/CAJA	PESO/PLT
ÁNG. PELD. 1PZ. 33 x 33/4	13" x 13"	1	0,33	90	3,7	333
PELDAÑO CUR. 36 x 33/4	14" x 13"	4	1,44	54	13,36	736
PELDAÑO CUR. 22,5 x 33/4	8,8" x 13"	6	1,35	64	12	783

PACKING PIEZAS ESPECIALES

FORMATO	PULGADAS	PZ/CAJA	ML	CAJA/PLT	PESO/CAJA	PESO/PLT
VIERTEAGUAS 15 x 22,5/4	5,9" x 8,8"	14	3,15	48	15,08	739
ZÓCALO 9 x 36	3,5" x 14"	30	10,8	56	23,8	1.275
ZANQUÍN 9 x 36	3,5" x 14"	30	10,8	56	19,6	1.135



EVOLUTIO
EXTRUDED PORCELAIN TILE

COLA DE MILANO - DOVETAIL
Seguridad de agarre - Grip safety

PE GRES EXTRUSIONADO PORCELÁNICO
PORCELAIN EXTRUDED TILE

PAV. DE EXTERIOR
OUTDOOR FLOOR TILE

PAV. DE INTERIOR
INDOOR FLOOR TILE

RESISTENTE AL DESGASTE
WEAR RESISTANCE

RESISTENTE AL RAYADO
SCRATCH RESISTANCE

ANTIDESLIZANTE
ANTISLIP

RES. A LA HELADA
FROST PROOF

RESIST. A ÁCIDOS Y BASES
RESIST. TO ACIDS & BASES

SIN MANTENIMIENTO
NO MAINTENANCE

SUPERFICIE BRILLO
GLOSS SURFACE

SUPERFICIE MATE
MATT SURFACE

DESTONIFICADO ARMONIOSO
CONTROLLED DESTONIFICATION

FORMATOS

6,5 x 25 - 2,5" x 10"
TRAB. ENM.
25 x 50 - 10" x 20"



BRILLO - GLOSSY



BOSTON BRICK DAY TRAB. ENM.
25 x 50 (G 60) 10" x 20"



BOSTON BRICK DAY
6,5 x 25 (G 39) 2,5" x 10"



BOSTON BRICK NIGHT TRAB. ENM.
25 x 50 (G 60) 10" x 20"



BOSTON BRICK NIGHT
6,5 x 25 (G 39) 2,5" x 10"

MATE - MATT

fine RESISTANCE ▶ R12 - Class III



BOSTON BRICK DOWNTOWN TRAB. ENM.
25 x 50 (G 60) 10" x 20"



BOSTON BRICK DOWNTOWN
6,5 x 25 (G 39) 2,5" x 10"



BOSTON BRICK EAST - NORTH TRAB. ENM.
25 x 50 (G 60) 10" x 20"



BOSTON BRICK EAST - NORTH
6,5 x 25 (G 39) 2,5" x 10"



BOSTON BRICK SOUTH TRAB. ENM.
25 x 50 (G 60) 10" x 20"



BOSTON BRICK SOUTH
6,5 x 25 (G 39) 2,5" x 10"



BOSTON BRICK WEST TRAB. ENM.
25 x 50 (G 60) 10" x 20"



BOSTON BRICK WEST
6,5 x 25 (G 39) 2,5" x 10"

PACKING BASES

FORMATO	PULGADAS	PZ/CAJA	M ²	CAJA/PLT	PESO/CAJA	PESO/PLT
6,5 x 25	2,5" x 10"	27	0,439	176	9,31	1,657
TRAB. 25 x 50	10" x 20"	6	0,75	53	14,1	753



COTTO NATURE



RESISTE LA FLEXIÓN 29 N/mm2	RESISTE EL DESGASTE PEI (III-IV)	RESISTE EL RAYADO MOHS - 8	ANTIDESLIZANTE CLASS III- R10	ANTID.TORUS 0,89 - 0,81	MANCHAS Class 5 - Class A	ABSORCIÓN 0,2%	DILATACIÓN 5,7* 10 ⁻⁴ /°C	fine RESISTANCE
29 N/mm2	PEI (III-IV)	MOHS - 6	CLASS I	-	Class 5 - Class A	0,2%	5,7* 10 ⁻⁴ /°C	Comfort floor
29 N/mm2	PEI (III-IV)	MOHS - 4	CLASS I	-	Class 5 - Class A	0,2%	5,7* 10 ⁻⁴ /°C	Comfort floor Olio



COLORES · COLORS



COTTO NATURE CERDEÑA
36 x 36 (G 57) 14" x 14" m²



COTTO NATURE CERDEÑA
18 x 36 (G 57) 7" x 14" m²



LOSANGA COTTO NATURE CERDEÑA
18 x 36 (G 12) 7" x 14" ◆



COTTO NATURE CERDEÑA
18 x 18 (G 57) 7" x 7" m²



COTTO NATURE SIENA
36 x 36 (G 57) 14" x 14" m²



COTTO NATURE SIENA
18 x 36 (G 57) 7" x 14" m²



LOSANGA COTTO NATURE SIENA
18 x 36 (G 12) 7" x 14" ◆



COTTO NATURE SIENA
18 x 18 (G 57) 7" x 7" m²



COTTO NATURE SICILIA OCT.
36 x 36 (G 57) 14" x 14" m²



COTTO NATURE SICILIA
36 x 36 (G 57) 14" x 14" m²



COTTO NATURE SICILIA
18 x 36 (G 57) 7" x 14" m²



LOSANGA COTTO NATURE SICILIA
18 x 36 (G 12) 7" x 14" ◆

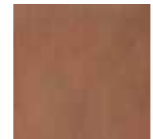

COTTO NATURE SICILIA
18 x 18 (G 57) 7" x 7" m²

PIEZAS ESPECIALES
SPECIAL PIECES
Disponibles en todos los colores
Available in all colors

SE FABRICAN EN CLASE I

Comfort floor



PELDAÑO CURVO
36 x 33/4 (G 18) 14" x 13" ◆

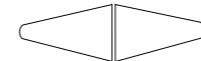

ÁNGULO PELDAÑO
33 x 46/4 (G 19 x 2PZ) 13" x 18" ◆

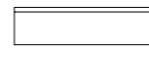

ZÓCALO
9 x 36 (G 07) 3,5" x 14" ◆

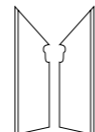

ZANQUÍN - IZQ. / DCHA.
9 x 36 (G 10) 3,5" x 14" ◆

COLORES OLIO · COLORS OLIO



COTTO NATURE CERDEÑA OLIO
36 x 36 (G 57) 14" x 14" m²



COTTO NATURE SIENA OLIO
36 x 36 (G 57) 14" x 14" m²



COTTO NATURE SICILIA OLIO
36 x 36 (G 57) 14" x 14" m²



COTTO NATURE SICILIA OLIO
18 x 36 (G 57) 7" x 14" m²



COTTO NATURE SICILIA OLIO
18 x 18 (G 57) 7" x 7" m²



LOSANGA COTTO NATURE SICILIA OLIO
18 x 36 (G 12) 7" x 14" ◆

MODULACIÓN · MODULATION — DISPONIBLE EN CLASE I

Comfort floor SICILIA OLIO · Comfort floor

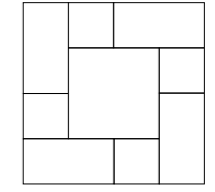

MODULO C (G 56)
packing: 1,04 m²/caja m²

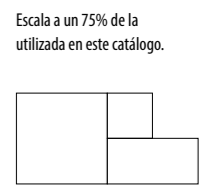

MODULO D (G 56)
packing: 0,91 m²/caja m²

Escala a un 75% de la utilizada en este catálogo.

PIEZAS ESPECIALES · SPECIAL PIECES — Disponible en todos los colores
Available in all colors

Comfort floor Olio



ZÓCALO
9 x 36 (G 07) 3,5" x 14" ◆

COLORES ANTIDESLIZANTE · COLORS ANTISLIP



COTTO NATURE CERDEÑA ANTISLIP
25 x 25 (G 24) 10" x 10" m²



COTTO NATURE SIENA ANTISLIP
25 x 25 (G 24) 10" x 10" m²



COTTO NATURE SICILIA ANTISLIP
25 x 25 (G 24) 10" x 10" m²



COTTO NATURE CERDEÑA ANTISLIP
36 x 36 (G 57) 14" x 14" m²



COTTO NATURE SIENA ANTISLIP
36 x 36 (G 57) 14" x 14" m²

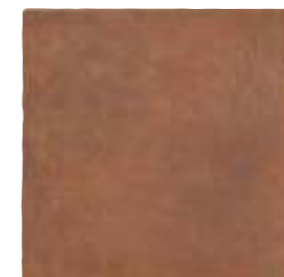

COTTO NATURE SICILIA ANTISLIP
36 x 36 (G 57) 14" x 14" m²

PIEZAS ESPECIALES · SPECIAL PIECES — SE FABRICAN EN CLASE III - R10
Available in all colors



PELDAÑO CURVO ANTISLIP
25 x 33/4 (G 16) 10" x 13" ◆
36 x 33/4 (G 18) 14" x 13" ◆



ZÓCALO ANTISLIP
9 x 25 (G 05) 3,5" x 10" ◆

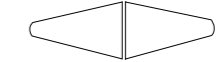

ÁNGULO PELDAÑO ANTISLIP
33 x 46/4 (G 19 x 2PZ) 13" x 18" ◆



VIERTEGUAS ANTISLIP
15 x 25/4 (G 10) 5,9" x 10" ◆

PACKING BASES

FORMATO	PULGADAS	PZ/CAJA	M ²	CAJA/PLT	PESO/CAJA	PESO/PLT
OCT. 36 x 36	14" x 14"	8	1	48	20,68	1.007
36 x 36	14" x 14"	8	1	48	22,04	1072
18 x 36	7" x 14"	16	1	72	23,33	1694
18 x 18	7" x 7"	30	0,97	72	21,4	1.555
25 x 25	10" x 10"	16	1	72	21,06	1.530
MODULO C	-	18	1,04	48	23	1.120
MODULO D	-	12	0,91	64	20	1.300

PACKING PIEZAS ESPECIALES

FORMATO	PULGADAS	PZ/CAJA	ML	CAJA/PLT	PESO/CAJA	PESO/PLT
LOSANGA 18 x 36	7" x 14"	16	5,76	72	22,82	1.657
ZÓCALO 9 x 36	3,5" x 14"	30	10,8	56	23,8	1.275
ZÓCALO 9 x 25	3,5" x 10"	40	10	48	24,1	1.171
PELD. CURVO 36 x 33/4	14" x 13"	4	1,44	54	13,36	736
PELD. CURVO 25 x 33/4	10" x 13"	6	1,5	54	13,48	743
ANG. PELD. 33 x 46/4	13" x 18"	2	0,33	90	3,46	325
ZANQUÍN 9 x 36	3,5" x 14"	30	10,8	56	19,6	1.135
VIERTEGUAS 15 x 25/4	5,9" x 10"	14	3,5	48	16,9	831

Nobleza



FORMATOS
25 x 25 - 10" x 10"
30 x 30 - 11,8" x 11,8"

Terracota

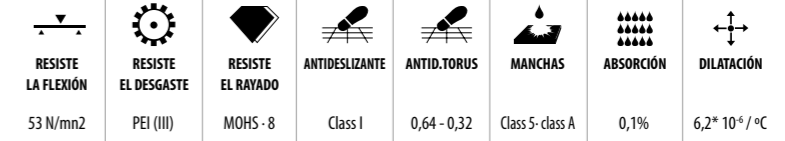

FORMATOS
25 x 25 - 10" x 10"

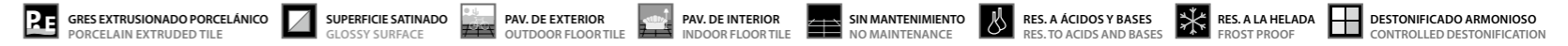

COLORES - COLORS EXTERIOR ▶ R10 - Class II



DECORACIÓN - DECORATION 3^o FUEGO



PACKING BASES

FORMATO	PULGADAS	PZ/CAJA	M ²	CAJA/PLT	PESO/CAJA	PESO/PLT
30 x 30	11,8" x 11,8"	11	1	72	20,27	1474
25 x 25	10" x 10"	16	1	72	21,06	1.530

PACKING PIEZAS ESPECIALES

FORMATO	PULGADAS	PZ/CAJA	ML	CAJA/PLT	PESO/CAJA	PESO/PLT
ANG. PELD. 33 x 46/4	13" x 18"	2	0,33	90	3,45	324
PELD. CURVO 30 x 33/4	11,8" x 13"	4	1,2	54	11,94	660
PELD. CURVO 25 x 33/4	10" x 13"	6	1,5	54	13,48	743
VIERTEGUAS 15 x 30/4	5,9" x 11,8"	14	4,2	36	19,84	729
VIERTEGUAS 15 x 25/4	5,9" x 10"	14	3,5	48	16,9	831
ZÓCALO 9 x 30	3,5" x 11,8"	30	9	56	19,6	1.112
ZÓCALO 9 x 25	3,5" x 10"	40	10	48	24,1	1.171
ZANQUÍN 9 x 30	3,5" x 11,8"	30	9	56	16,24	924

COLORES - COLORS Comfort floor ▶ Class I



DECORACIÓN - DECORATION 3^o FUEGO

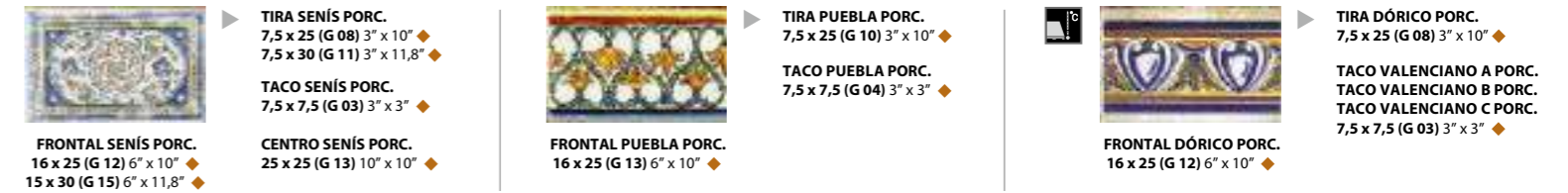

PACKING DECORADOS

FORMATO	PULGADAS	PZ/CAJA	ML	CAJA/PLT	PESO/CAJA	PESO/PLT
FRONTAL 16 x 25	6" x 10"	20	5	48	16,3	797
TIRA 7,5 x 25	3" x 10"	50	12,5	48	20,1	979
TACO 7,5 x 7,5	3" x 3"	60	4,5	44	7,06	325
FRONTAL 15 x 30	6" x 11,8"	20	6	56	19,4	-
TIRA 7,5 x 30	3" x 11,8"	36	10,18	64	16,91	-
CENTRO 25 x 25	10" x 10"	16	4	72	21,06	-

PACKING PIEZAS ESPECIALES

FORMATO	PULGADAS	PZ/CAJA	ML	CAJA/PLT	PESO/CAJA	PESO/PLT
ANG. PELD. 33 x 33	13" x 13"	1	0,33	90	3,98	373
PELD. CURVO 25 x 33/4	10" x 13"	6	1,5	54	13,48	743
VIERTEGUAS 15 x 25/4	5,9" x 10"	14	3,5	48	16,9	831
ZÓCALO 9 x 25	3,5" x 10"	40	10	48	24,1	1.171
ZANQUÍN 9 x 25	3,5" x 10"	40	10	48	24,1	-

TECH·LAND DECOR

fine **RESISTANCE**

EVOLUTIV
EXTRUDED PORCELAIN TILE

CLASE III-R11
CLASS II-R11

in & out
INTERIOR - EXTERIOR

ANTI-BACTERIAL



PE GRES EXTR. PORCELÁNICO
PORCELAIN EXTRUDED TILE

PAV. DE INTERIOR
INDOOR FLOOR TILE

PAVIMENTO DE EXTERIOR
OUTDOOR FLOOR TILE

SUPERFICIE MATE
MATT SURFACE

SIN MANTENIMIENTO
NO MAINTENANCE

DESTONIFICADO ARMONIOSO
CONTROLLED DESTONIFICATION

RESIST. A LA HELADA
FROST PROOF

RESIST. A ÁCIDOS Y BASES
RESIST. TO ACIDS & BASES



FUERZA DE ROTURA
3119 Nw



CARGA DE ROTURA
3408 Nw



RESISTE LA FLEXIÓN
28 N/mm2



RESISTE EL DESGASTE
PEI (II-III)



RESISTE EL RAYADO
MOHS - 8



ANTIDESLIZANTE
Clase III - R11



ANTID. DCOF.
0,69



ANTID. DIN 51097
Clase C > 37°



MANCHAS
Class 5 - Class A



ABSORCIÓN
0,3%



DILATACIÓN
6,6° 10° / °C



ANTIBACTERIANO
Norma JIS Z 2801



DECORACIÓN · DECORATION

La serie TECH LAND DECOR combina con las bases de la serie TECH LAND FIRE pág. 56
TECH LAND DECOR combines with TECH LAND FIRE collection, pág. 56

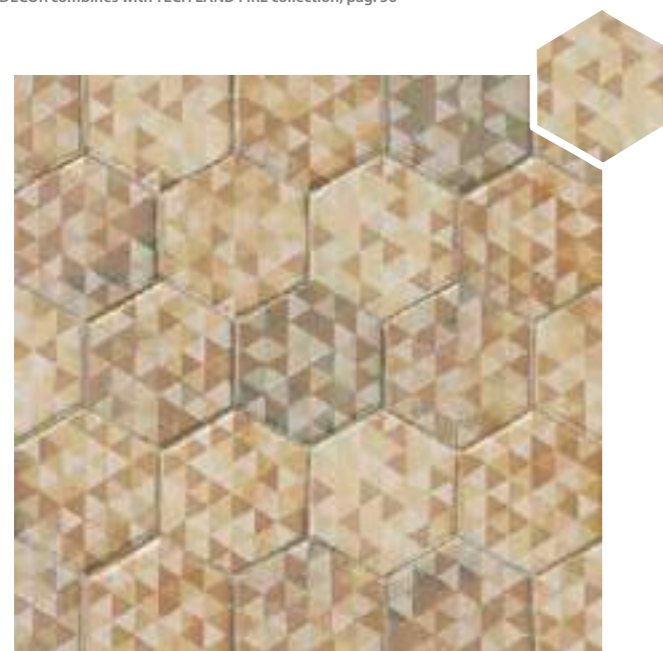

TECH LAND VINE FIRE
18 x 20,5 (G 27) 7" x 8" **ml**



TECH LAND CUBIK FIRE
18 x 20,5 (G 27) 7" x 8" **ml**



TECH LAND COAT FIRE
22,5 x 22,5 (G 56) 8,8" x 8,8" **ml**

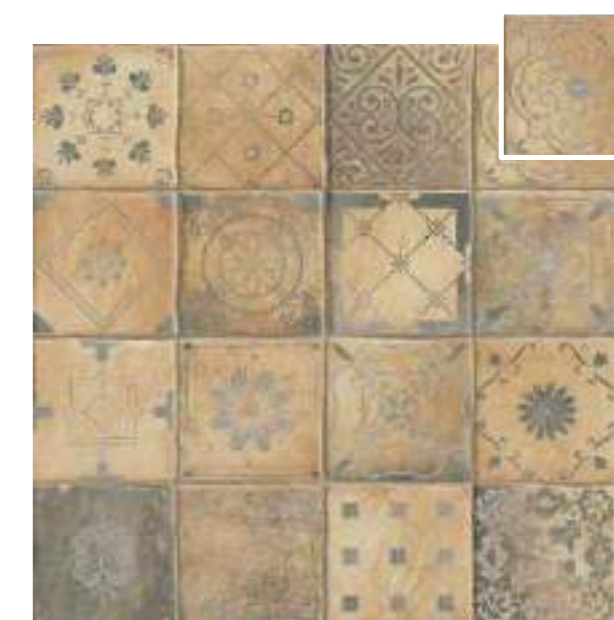

TECH LAND TEMPLE FIRE
22,5 x 22,5 (G 56) 8,8" x 8,8" **ml**

PACKING DECOR

FORMATO	PULGADAS	PZ/CAJA	M ²	CAJA/PLT	PESO/CAJA	PESO/PLT
HEX 18 x 20,5	7" x 8"	30	0,83	48	22,57	1,098

PACKING DECOR

FORMATO	PULGADAS	PZ/CAJA	M ²	CAJA/PLT	PESO/CAJA	PESO/PLT
22,5 x 22,5	8,8" x 8,8"	17	0,86	60	23,19	1,406

DECORACIÓN - DECORATION



TECH LAND STAR FIRE
15,5 x 15,5 (G 52) 6" x 6" m



TECH LAND STAR TEMPLE FIRE
15,5 x 15,5 (G 52) 6" x 6" m



TECH LAND CROSS FIRE
15,5 x 15,5 (G 52) 6" x 6" m



TECH LAND CROSS TEMPLE FIRE
15,5 x 15,5 (G 52) 6" x 6" m



TECH LAND CROSS FIRE
15,5 x 15,5 (G 52) 6" x 6" m

TECH LAND STAR FIRE
15,5 x 15,5 (G 52) 6" x 6" m



TECH LAND CROSS TEMPLE FIRE
15,5 x 15,5 (G 52) 6" x 6" m

TECH LAND STAR FIRE
15,5 x 15,5 (G 52) 6" x 6" m



TECH LAND STAR TEMPLE FIRE
15,5 x 15,5 (G 52) 6" x 6" m

TECH LAND CROSS FIRE
15,5 x 15,5 (G 52) 6" x 6" m

DECORADOS - DECORATION



TACO SANDRO PORC.
6,5 x 6,5 (G 11) 3" x 3" ◆



TACO VERSILIA
4 x 4 (G 04) 2" x 2" ◆



TACO VOLTERRA
4 x 4 (G 04) 2" x 2" ◆



TECH LAND CROSS TEMPLE FIRE
15,5 x 15,5 (G 52) 6" x 6" m

TECH LAND STAR TEMPLE FIRE
15,5 x 15,5 (G 52) 6" x 6" m

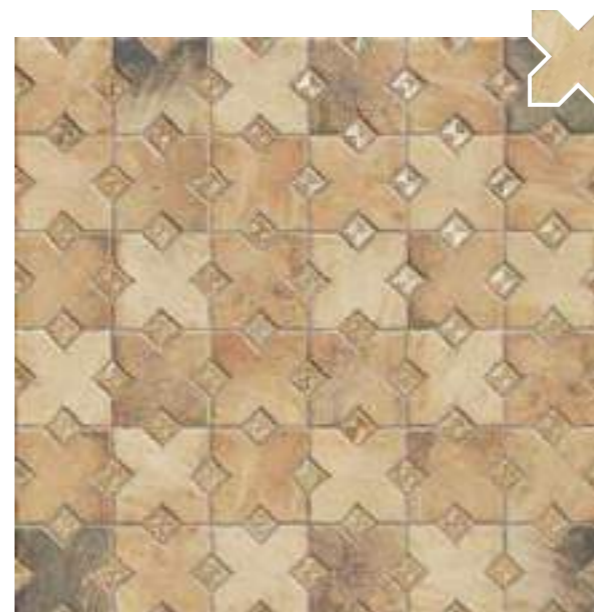

TECH LAND CROSS FIRE
15,5 x 15,5 (G 52) 6" x 6" m

TACO VOLTERRA
4 x 4 (G 04) 2" x 2" ◆



TECH LAND CROSS FIRE
15,5 x 15,5 (G 52) 6" x 6" m

TACO VERSILIA
4 x 4 (G 04) 2" x 2" ◆

PACKING DECOR

FORMATO	PULGADAS	PZ/CAJA	M ²	CAJA/PLT	PESO/CAJA	PESO/PLT
STAR 15,5 x 15,5	6" x 6"	12	0,34	96	9,9	966
CROSS 15,5 x 15,5	6" x 6"	18	0,44	105	10,40	1.107

PACKING DECOR

FORMATO	PULGADAS	PZ/CAJA	M ²	CAJA/PLT	PESO/CAJA	PESO/PLT
TACO 6,5 x 6,5	3" x 3"	60	3,9	60	5,02	-
TACO 4 x 4	2" x 2"	50	2	60	2,1	-

TECH·LAND DECOR

fine **RESISTANCE**

EVOLUTIVON
EXTRUDED PORCELAIN TILE

CLASE III-R11
CLASS III-R11

in & out
INTERIOR - EXTERIOR

ANTI-BACTERIAL



PE GRES EXTR. PORCELÁNICO
PORCELAIN EXTRUDED TILE

PAV. DE INTERIOR
INDOOR FLOOR TILE

PAVIMENTO DE EXTERIOR
OUTDOOR FLOOR TILE

SUPERFICIE MATE
MATT SURFACE

SIN MANTENIMIENTO
NO MAINTENANCE

DESTONIFICADO ARMONIOSO
CONTROLLED DESTONIFICATION

RESIST. A LA HELADA
FROST PROOF

RESIST. A ÁCIDOS Y BASES
RESIST. TO ACIDS & BASES



FUERZA DE ROTURA
3119 Nw



CARGA DE ROTURA
3408 Nw



RESISTE LA FLEXIÓN
28 N/mm2



RESISTE EL DESGASTE
PEI (II-III)



RESISTE EL RAYADO
MOHS - 8



ANTIDESLIZANTE
Clase III - R11



ANTID. DCOF.
0,69



ANTID. DIN 51097
Clase C > 37°



MANCHAS
Class S - Class A



ABSORCIÓN
0,3%



DILATACIÓN
6,6° 10° / °C



ANTIBACTERIANO
Norma JIS Z 2801



TECH LAND ASTRO TERRA
22,5 x 22,5 (G 56) 8,8" x 8,8" m



TECH LAND ASTRO DARK
22,5 x 22,5 (G 56) 8,8" x 8,8" m



TECH LAND TEMPLE NATURAL
22,5 x 22,5 (G 56) 8,8" x 8,8" m



TECH LAND CRAYON SKY NATURAL
22,5 x 22,5 (G 56) 8,8" x 8,8" m

DECORACIÓN · DECORATION

La serie TECH LAND DECOR combina con las bases de la serie TECH LAND NATURAL pág. 57
TECH LAND DECOR combines with TECH LAND NATURAL collection, pág. 57



TECH LAND FIBBER NATURAL
18 x 20,5 (G 27) 7" x 8" m



TECH LAND CRAYON RED NATURAL
18 x 20,5 (G 27) 7" x 8" m



TECH LAND PLANET NATURAL
22,5 x 22,5 (G 56) 8,8" x 8,8" m

TECH LAND PLANET PERMITE
MÚLTIPLES POSIBILIDADES
COMPOSITIVAS
TECH LAND PLANET OFFERS
INFINITE COMPOSITIVE
POSSIBILITIES

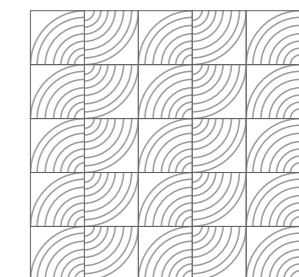
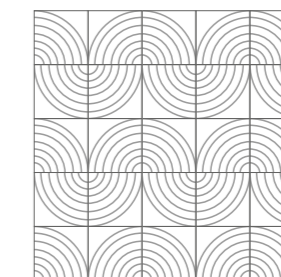
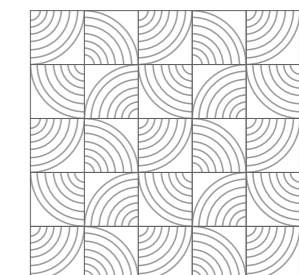

PACKING DECOR

FORMATO	PULGADAS	PZ/CAJA	M ²	CAJA/PLT	PESO/CAJA	PESO/PLT
HEX 18 x 20,5	7" x 8"	30	0,83	48	22,57	1.098

PACKING DECOR

FORMATO	PULGADAS	PZ/CAJA	M ²	CAJA/PLT	PESO/CAJA	PESO/PLT
22,5 x 22,5	8,8" x 8,8"	17	0,86	60	23,19	1.406

TECH·LAND DECOR

fine **RESISTANCE**

EVOLUTION
EXTRUDED PORCELAIN TILE

CLASE III-R11
CLASS II-R11 SOFT

in & out
INTERIOR - EXTERIOR

ANTI-BACTERIAL



PE GRES EXTR. PORCELÁNICO
PORCELAIN EXTRUDED TILE

SUPERFICIE MATE
MATT SURFACE

PAV. DE INTERIOR
INDOOR FLOOR TILE

SIN MANTENIMIENTO
NO MAINTENANCE

RESIST. A LA HELADA
FROST PROOF

PAVIMENTO DE EXTERIOR
OUTDOOR FLOOR TILE

DESTONIFICADO ARMONIOSO
CONTROLLED DESTONIFICATION

RESIST. A ÁCIDOS Y BASES
RESIST. TO ACIDS & BASES



FUERZA DE ROTURA
3119 Nw



CARGA DE ROTURA
3408 Nw



RESISTE LA FLEXIÓN
28 N/mm2



RESISTE EL DESGASTE
PEI (II-III)



RESISTE EL RAYADO
MOHS - 8



ANTIDESLIZANTE
Clase III - R11



ANTID. DCOF.
0,69



ANTID. DIN 51097
Clase C > 37°



MANCHAS
Class 5 - Class A



ABSORCIÓN
0,3%



DILATACIÓN
6,6° 10° / °C



ANTIBACTERIANO
Norma JIS Z 2801



DECORACIÓN · DECORATION

La serie **TECH LAND DECOR** combina con las bases de la serie **TECH LAND BASALT** pág. 58
TECH LAND DECOR combines with TECH LAND BASALT collection, pág. 58



TECH LAND FIBBER BASALT
18 x 20,5 (G 27) 7" x 8" m



TECH LAND CRAYON RED BASALT
18 x 20,5 (G 27) 7" x 8" m

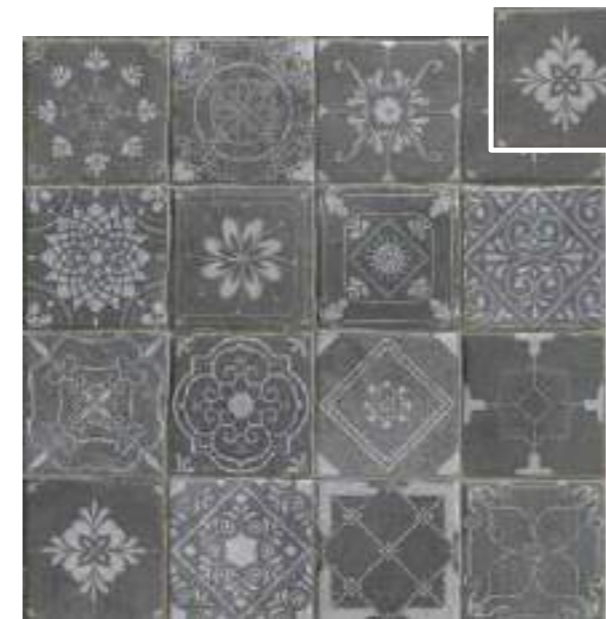

TECH LAND TEMPLE BASALT
22,5 x 22,5 (G 56) 8,8" x 8,8" m



TECH LAND CRAYON SKY BASALT
22,5 x 22,5 (G 56) 8,8" x 8,8" m



TECH LAND PLANET BASALT
22,5 x 22,5 (G 56) 8,8" x 8,8" m

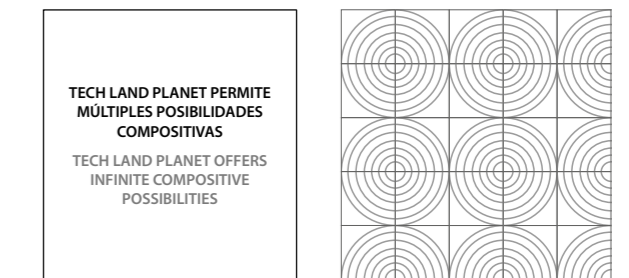

**TECH LAND PLANET PERMITE
MÚLTIPLES POSIBILIDADES
COMPOSITIVAS**
TECH LAND PLANET OFFERS
INFINITE COMPOSITIVE
POSSIBILITIES

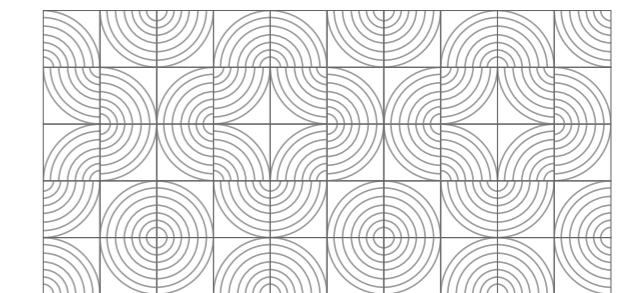

PACKING DECOR

FORMATO	PULGADAS	PZ/CAJA	M ²	CAJA/PLT	PESO/CAJA	PESO/PLT
HEX 18 x 20,5	7" x 8"	30	0,83	48	22,57	1,098

PACKING DECOR

FORMATO	PULGADAS	PZ/CAJA	M ²	CAJA/PLT	PESO/CAJA	PESO/PLT
22,5 x 22,5	8,8" x 8,8"	17	0,86	60	23,19	1,406

PALAZZO



- RESISTE LA FLEXIÓN**
30 N/m2
- RESISTE EL DESGASTE**
PEI (II - V)
- RESISTE EL RAYADO**
MOHS - 9
- ANTIDESLIZANTE**
Class I - R9
- MANCHAS**
Class 5 - Class A
- ABSORCIÓN**
<0,5%
- DILATACIÓN**
6,0° 10°/°C

-
-
-
-
-
-
-
-
-
-



DECORACIÓN · DECORATION

GRANO FINO · FINE GRAINED

La serie PALAZZO combina con las bases de la serie PALAZZO pág. 32-35
 PALAZZO combines with PALAZZO collection, pág. 32-35

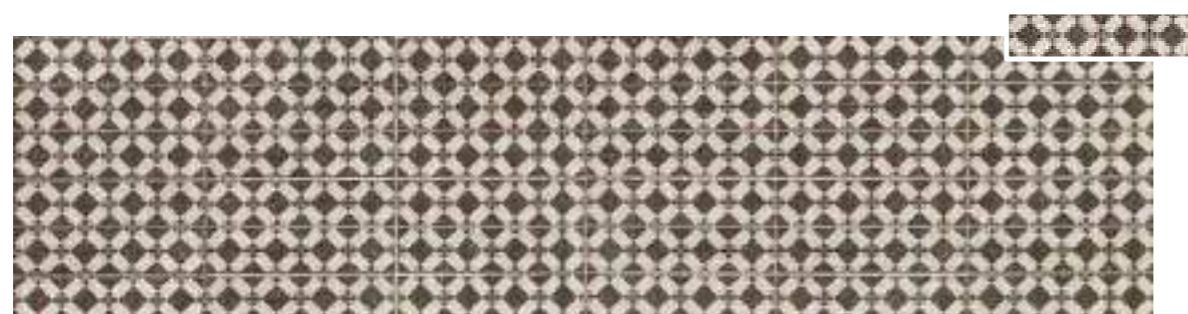

PALAZZO SAN LORENZO
 7,5 x 30 (G 56) 3" x 11,8" m



PALAZZO SAN GIACOMO
 7,5 x 30 (G 56) 3" x 11,8" m



PALAZZO SAN NICCOLO
 7,5 x 30 (G 56) 3" x 11,8" m

PACKING DECOR

FORMATO	PULGADAS	PZ/CAJA	M²	CAJA/PLT	PESO/CAJA	PESO/PLT
7,5 x 30	3" x 11,8"	22	0,5	120	10,25	1.245

PALAZZO



DECORACIÓN · DECORATION

La serie PALAZZO combina con las bases de la serie PALAZZO pág. 32-35
PALAZZO combines with PALAZZO collection, pág. 32-35

GRANO FINO · FINE GRAINED



PALAZZO PIERO
22,5 x 22,5 (G 57) 8,8" x 8,8" m



PALAZZO BALBI
22,5 x 22,5 (G 57) 8,8" x 8,8" m



PALAZZO NICOLA
22,5 x 22,5 (G 57) 8,8" x 8,8" m



PALAZZO DUCALE
22,5 x 22,5 (G 57) 8,8" x 8,8" m

PACKING DECOR

FORMATO	PULGADAS	PZ/CAJA	M ²	CAJA/PLT	PESO/CAJA	PESO/PLT
22,5 x 22,5	8,8" x 8,8"	20	1,01	72	20,27	1,474

PALAZZO



DECORACIÓN · DECORATION

La serie PALAZZO combina con las bases de la serie PALAZZO pág. 32-35
PALAZZO combines with PALAZZO collection, pág. 32-35

GRANO FINO · FINE GRAINED



PALAZZO RIALTO
22,5 x 22,5 (G 57) 8,8" x 8,8" m



PALAZZO BALBI COLORI
22,5 x 22,5 (G 57) 8,8" x 8,8" m



PALAZZO LUIGI
22,5 x 22,5 (G 57) 8,8" x 8,8" m

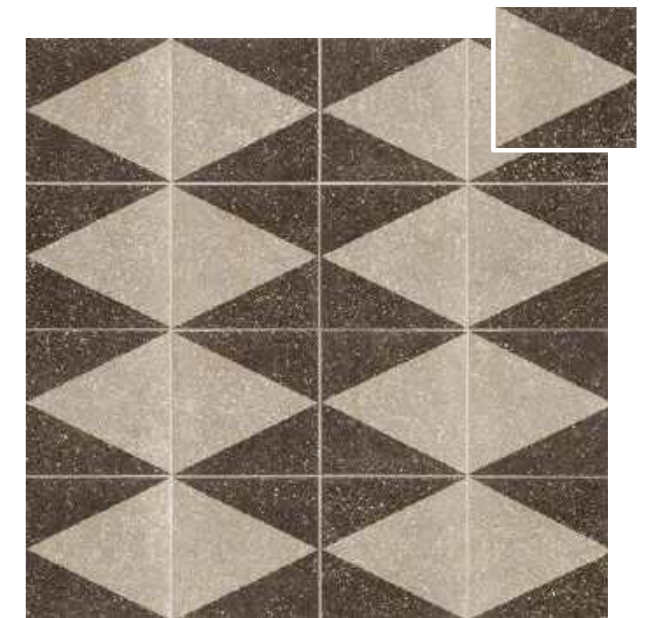

PALAZZO MEDICI
22,5 x 22,5 (G 57) 8,8" x 8,8" m

PACKING DECOR

FORMATO	PULGADAS	PZ/CAJA	M ²	CAJA/PLT	PESO/CAJA	PESO/PLT
22,5 x 22,5	8,8" x 8,8"	20	1,01	72	20,27	1,474

PALAZZO



DECORACIÓN · DECORATION

La serie PALAZZO combina con las bases de la serie PALAZZO pág. 32-35
PALAZZO combines with PALAZZO collection, pág. 32-35

GRANO GRUESO · COARSE GRAINED



PALAZZO SAN POLO
30 x 30 (G 57) 11,8" x 11,8" m



PALAZZO SAN ROCCO
30 x 30 (G 57) 11,8" x 11,8" m



PALAZZO SAN MARCOS
30 x 30 (G 57) 11,8" x 11,8" m

SAN MARCOS
POSIBILIDADES
COMPOSITIVAS

SAN MARCOS
COMPOSITE
POSSIBILITIES

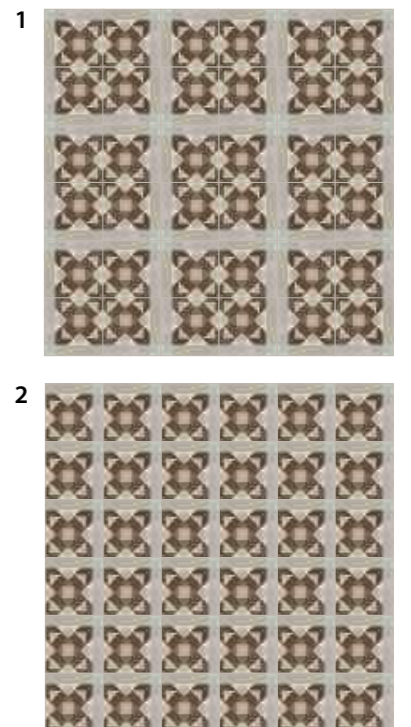

PACKING DECOR

FORMATO	PULGADAS	PZ/CAJA	M ²	CAJA/PLT	PESO/CAJA	PESO/PLT
30 x 30	11,8" x 11,8"	11	1	72	20,27	1,474



MIX VARESE
22,5 x 22,5 (G 57) 8,8" x 8,8" m



VARENNA
22,5 x 22,5 (G 57) 8,8" x 8,8" m



FLORENCE
22,5 x 22,5 (G 57) 8,8" x 8,8" m



LATERZA
22,5 x 22,5 (G 57) 8,8" x 8,8" m

DECORACIÓN · DECORATION

La serie D'ANTICATTO DECOR combina con las bases de la serie D'ANTICATTO pág. 60-63
D'ANTICATTO DECOR combines with D'ANTICATTO collection, pág. 60-63

fine RESISTANCE ▶ R11 - Class III



TRIANGOLI
22,5 x 22,5 (G 57) 8,8" x 8,8" m



QUADRATI
22,5 x 22,5 (G 57) 8,8" x 8,8" m



OBLIQUA
22,5 x 22,5 (G 57) 8,8" x 8,8" m

D'ANTICATTO OBLIQUA PERMITE
MÚLTIPLES POSIBILIDADES
COMPOSITIVAS
D'ANTICATTO OBLIQUA OFFERS
INFINITE COMPOSITE
POSSIBILITIES

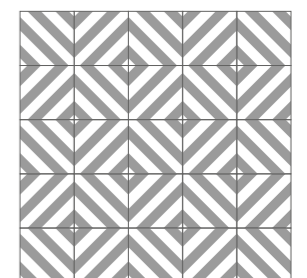
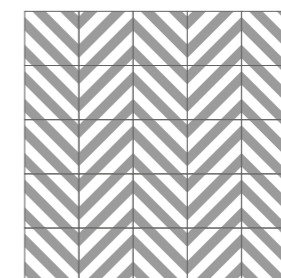
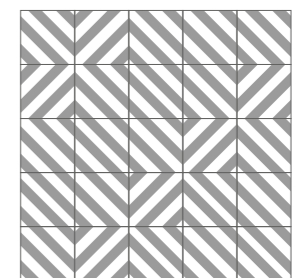

PACKING DECOR

FORMATO	PULGADAS	PZ/CAJA	M ²	CAJA/PLT	PESO/CAJA	PESO/PLT
22,5 x 22,5	8,8" x 8,8"	20	1,01	72	20,7	1,505



RESISTE LA FLEXIÓN 37 N/mm ²	RESISTE EL DESGASTE PEI (III - IV)	RESISTE EL RAYADO MOHS - 9	ANTIDESLIZANTE Class III - R12	ANTID.TORUS 0,82 - 0,76	MANCHAS Class 5 - Class A	ABSORCIÓN 0,1%	DILATACIÓN 6,4° 10° / °C
--	---------------------------------------	-------------------------------	-----------------------------------	----------------------------	------------------------------	-------------------	-----------------------------

GRES EXTRUDEDADO PORCELÁNICO PORCELAIN EXTRUDED TILE	SUPERFICIE MATE MATT SURFACE	PAV. DE INTERIOR INDOOR FLOOR TILE	PAV. DE EXTERIOR OUTDOOR FLOOR TILE	SIN MANTENIMIENTO NO MAINTENANCE	RES. A ÁCIDOS Y BASES RES. TO ACIDS AND BASES	RES. A LA HELADA FROST PROOF	DESTONIFICADO ARMONIOSO CONTROLLED DESTONIFICATION
---	---------------------------------	---------------------------------------	--	-------------------------------------	--	---------------------------------	---



DECORACIÓN · DECORATION

La serie AMERICAN combina con las bases de la serie BOSTON pág. 66-69
AMERICAN combines with BOSTON collection, pág. 66-69



AMERICAN MELROSE (MIX)
22,5 x 22,5 (G 57) 8,8" x 8,8" m



AMERICAN HARVARD (MIX)
22,5 x 22,5 (G 57) 8,8" x 8,8" m



AMERICAN NEWTON
22,5 x 22,5 (G 57) 8,8" x 8,8" m



AMERICAN CLEVELAND
22,5 x 22,5 (G 57) 8,8" x 8,8" m

PACKING DECOR

FORMATO	PULGADAS	PZ/CAJA	M ²	CAJA/PLT	PESO/CAJA	PESO/PLT
22,5 x 22,5	8,8" x 8,8"	20	1,01	72	20,7	1,505



DECORACIÓN · DECORATION

Comfort floor ▶ Class I

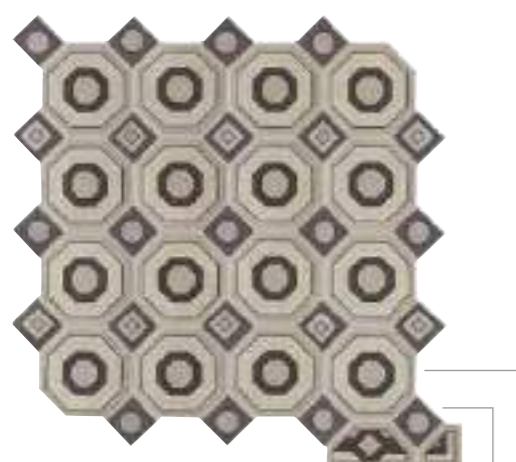

CEMENTI OTTO LIN

CENEFA 6,1 x 12,2 (G 06) 2,8" x 4,8" ◆
ESQUINA 6,1 x 6,1 (G 06) 2,8" x 2,8" ◆
TACO 5 x 5 (G 02) 2" x 2" ◆
OCT. 12,2 x 12,2 (G 06) 4,8" x 4,8" ◆
ENM. (12,2 x 12,2) 37 x 37 (G 40) 14,5" x 14,5" m



CEMENTI OTTO VIC

TACO 5 x 5 (G 02) 2" x 2" ◆
OCT. 12,2 x 12,2 (G 06) 4,8" x 4,8" ◆
ENM. (12,2 x 12,2) 37 x 37 (G 40) 14,5" x 14,5" m

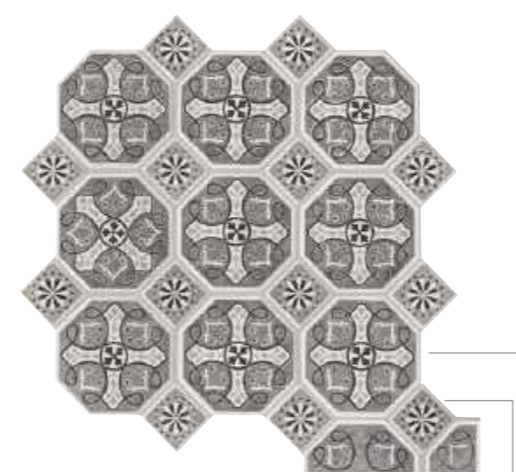

CEMENTI OTTO FLO

CENEFA 8,5 x 17 (G 10) 3,3" x 6,6" ◆
ESQUINA 8,5 x 8,5 (G 10) 3,3" x 3,3" ◆
TACO 7 x 7 (G 02) 2,7" x 2,7" ◆
OCT. 17 x 17 (G 10) 6,6" x 6,6" ◆
ENM. (17 x 17) 35 x 35 (G 53) 13,7" x 13,7" m

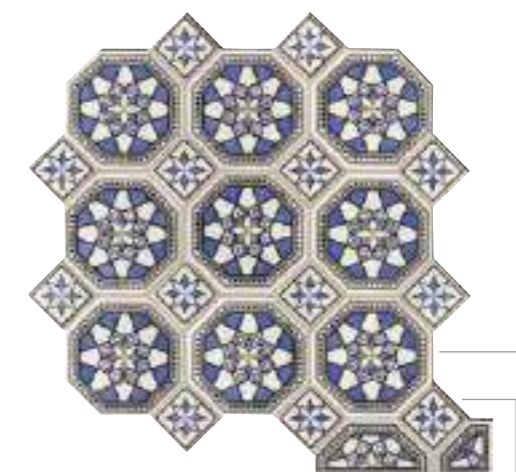

CEMENTI OTTO ALA BLUE

CENEFA 8,5 x 17 (G 10) 3,3" x 6,6" ◆
ESQUINA 8,5 x 8,5 (G 10) 3,3" x 3,3" ◆
TACO 7 x 7 (G 02) 2,7" x 2,7" ◆
OCT. 17 x 17 (G 10) 6,6" x 6,6" ◆
ENM. (17 x 17) 35 x 35 (G 53) 13,7" x 13,7" m

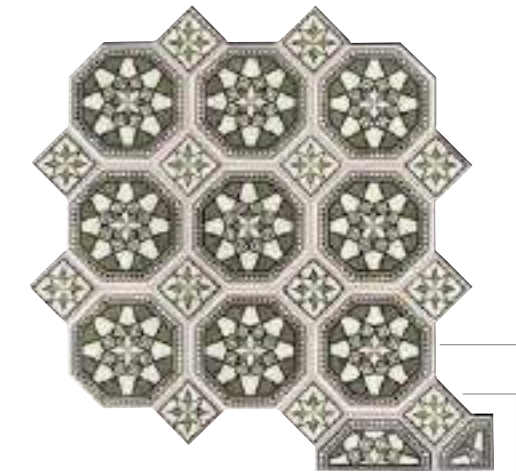

CEMENTI OTTO ALA VERDE

CENEFA 8,5 x 17 (G 10) 3,3" x 6,6" ◆
ESQUINA 8,5 x 8,5 (G 10) 3,3" x 3,3" ◆
TACO 7 x 7 (G 02) 2,7" x 2,7" ◆
OCT. 17 x 17 (G 10) 6,6" x 6,6" ◆
ENM. (17 x 17) 35 x 35 (G 53) 13,7" x 13,7" m

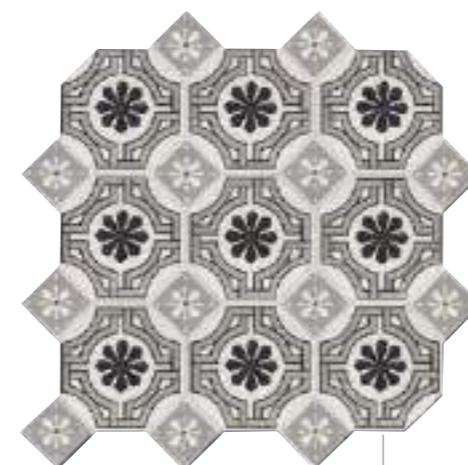

CEMENTI OTTO MED GRIS

TACO GRIS 7 x 7 (G 02) 2,7" x 2,7" ◆
OCT. 17 x 17 (G 10) 6,6" x 6,6" ◆
ENM. (17 x 17) 35 x 35 (G 53) 13,7" x 13,7" m



CEMENTI OTTO MED

TACO GRIS 7 x 7 (G 02) 2,7" x 2,7" ◆
OCT. 17 x 17 (G 10) 6,6" x 6,6" ◆
ENM. (17 x 17) 35 x 35 (G 53) 13,7" x 13,7" m

PACKING

FORMATO	PULGADAS	PZ/CAJA	M ²	ML	CAJA/PLT	PESO/CAJA	PESO/PLT
17 x 17	6,6" x 6,6"	31	0,74	5,27	72	17,15	1.249
12,2 x 12,2	4,8" x 4,8"	42	0,525	5,12	60	12,90	790
CENEFA 8,5 x 17	3,3" x 6,6"	26	-	4,42	56	7,25	-
CENEFA 6,1 x 12,2	2,8" x 4,8"	15	-	1,28	56	2,17	-
ESQUINA 8,5 x 8,5	3,3" x 3,3"	15	-	1,28	56	2,17	-
ESQUINA 6,1 x 6,1	2,8" x 2,8"	36	-	4,39	56	5,61	-
TACO 7 x 7	2,7" x 2,7"	58	-	4,06	44	2,6	-
TACO 5 x 5	2" x 2"	90	-	4,5	60	2,08	-
ENM. (17x17) 35 x 35	13,7" x 13,7"	7	0,86	2,45	40	24,6	998
ENM. (12,2x12,2) 37 x 37	14,5" x 14,5"	7	0,96	2,59	56	21,8	1.235

Composición por metro:

17 x 17 Cementi Oct. 35Pz · 7 x 7 Taco Cementi 35 Pz.
12,2 x 12,2 Cementi Oct. 68 Pz · 5 x 5 Taco Cementi 68 Pz.

MODELI

Comfort floor
EVOLUTION
EXTRUDED PORCELAIN TILE

RESISTE LA FLEXIÓN
30 N/mn2

ANTIDESLIZANTE
Class I

MANCHAS
Class 5 - Class A

ABSORCIÓN
0,2%

DILATACIÓN
6,6° 10° / °C

PE GRES EXTRUSIONADO PORCELÁNICO
PORCELAIN EXTRUDED TILE

SUPERFICIE SATINADO
GLOSSY SURFACE

PAV. DE INTERIOR
INDOOR FLOOR TILE

SIN MANTENIMIENTO
NO MAINTENANCE

RES. A ÁCIDOS Y BASES
RES. TO ACIDS AND BASES

RES. A LA HELADA
FROST PROOF

DESTONIFICADO ARMONIOSO
CONTROLLED DESTONIFICATION



DECORACIÓN · DECORATION

Comfort floor ▶ Class I

COMBINA · COMBINE



MODELI MIX
HEX. 15 x 17 (G 54) 6" x 7" m



HEX. (10) NEW PANAL FARINA
15 x 17 (G 63) 6" x 7" m



HEX. (10) NEW PANAL CARBO
15 x 17 (G 63) 6" x 7" m



PACKING

FORMATO	PULGADAS	PZ/CAJA	M²	ML	CAJA/PLT	PESO/CAJA
HEX. 15 x 17	6" x 7"	26	0,5	80	12,45	1.010

BELLA

Pasta Blanca

EFFECT
MICRO CRAQUELÉ

EFFECT ABOMBED

 SUPERFICIE BRILLO
SURFACE BRIGTNES

 REVESTIMIENTO
WALL TILE

FORMATOS
7,5 x 15 - 3" x 6"

 SUPERFICIE MATE
MATT SURFACE

 SIN MANTENIMIENTO
NO MAINTENANCE



MATE - MATT



BELLA BIANCA MATTE
7,5 x 15 (G 59) 3" x 6" m²

BRILLO - GLOSSY



BELLA CRAQUELÉ BIANCA
7,5 x 15 (G 59) 3" x 6" m²



BELLA CRAQUELÉ BEIGE
7,5 x 15 (G 59) 3" x 6" m²



BELLA CRAQUELÉ GRIGIA
7,5 x 15 (G 59) 3" x 6" m²



BELLA CRAQUELÉ ROSA
7,5 x 15 (G 59) 3" x 6" m²



BELLA CRAQUELÉ MENTA
7,5 x 15 (G 59) 3" x 6" m²

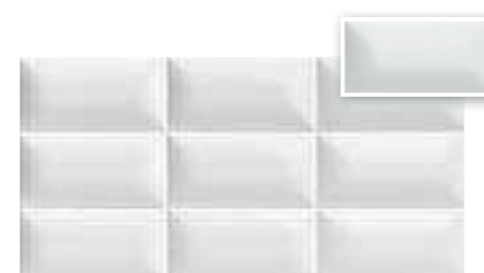

BELLA CRAQUELÉ AZURRA
7,5 x 15 (G 59) 3" x 6" m²



EFFECT
MICRO CRAQUELÉ

PACKING BASES

FORMATO	PULGADAS	PZ/CAJA	M²	CAJA/PLT	PESO/CAJA	PESO/PLT
7,5 x 15	3" x 6"	44	0,5	120	8,5	1,034

BELLA

EVOLUTION
EXTRUDED PORCELAIN TILE

PE GRES EXTRUSIONADO PORCELÁNICO
PORCELAIN EXTRUDED TILE

SUPERFICIE BRILLO
SURFACE BRIGTNSS

SUPERFICIE MATE
MATT SURFACE

REVESTIMIENTO
WALL TILE

RESIST. A LA HELADA
FROST PROOF

SIN MANTENIMIENTO
NO MAINTENANCE

FORMATOS

7,5 x 30 - 3" x 12"
HEXAGONO 18 x 20,5 - 7" x 8"



MATE · MATT

fine **RESISTANCE** ▶ R11 - Class III

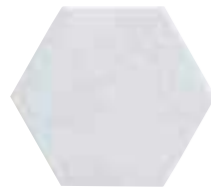

BELLA AZURRA HEX
18 x 20,5 (G 39) 7" x 8" **mm**

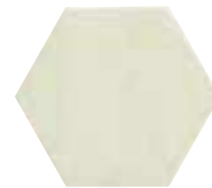

BELLA MENTA HEX
18 x 20,5 (G 39) 7" x 8" **mm**



BELLA ROSA HEX
18 x 20,5 (G 39) 7" x 8" **mm**



BELLA GRIGIA HEX
18 x 20,5 (G 39) 7" x 8" **mm**

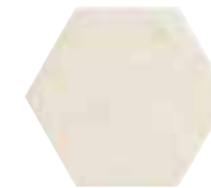

BELLA BEIGE HEX
18 x 20,5 (G 39) 7" x 8" **mm**

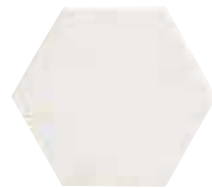

BELLA BIANCA HEX
18 x 20,5 (G 39) 7" x 8" **mm**

BRILLO · GLOSSY



BELLA AZURRA
7,5 x 30 (G 58) 3" x 12" **mm**



BELLA MENTA
7,5 x 30 (G 58) 3" x 12" **mm**



BELLA ROSA
7,5 x 30 (G 58) 3" x 12" **mm**



BELLA GRIGIA
7,5 x 30 (G 58) 3" x 12" **mm**



BELLA BEIGE
7,5 x 30 (G 58) 3" x 12" **mm**



BELLA BIANCA
7,5 x 30 (G 58) 3" x 12" **mm**

PACKING BASES

FORMATO	PULGADAS	PZ/CAJA	M ²	CAJA/PLT	PESO/CAJA	PESO/PLT
HEX. 18 x 20,5	7" x 8"	36	1	48	21	1,024
7,5 x 30	3" x 12"	22	0,5	120	8,5	1,034

ZELLIGE

Pasta Blanca

REVESTIMIENTO
WALL TILE

DESTONIFICADO ARMONIOSO
CONTROLLED DESTONIFICATION

SUPERFICIE BRILLO
SURFACE BRIGTNES

BORDES Y SUPERFICIE IRREGULAR
IRREGULAR EDGES AND SUFACE

FORMATOS:
6,2 x 25 - 2,5" x 10"

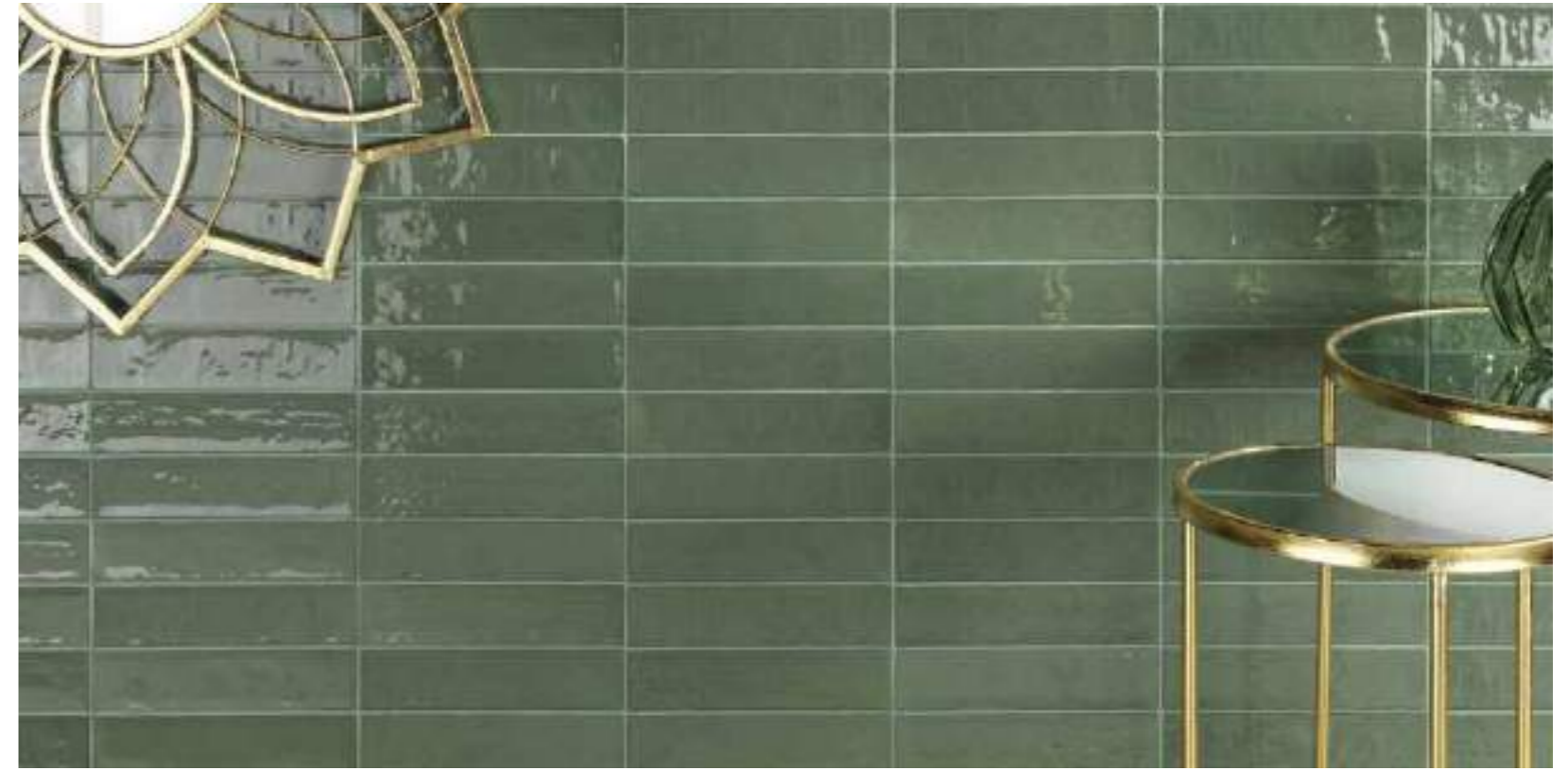

MATE - MATT



ZELLIGE WHITE MATT
6,2 x 25 (G 27) 2,5" x 10" m²

COLORES - COLORS



ZELLIGE WHITE
6,2 x 25 (G 27) 2,5" x 10" m²



ZELLIGE BEIGE
6,2 x 25 (G 27) 2,5" x 10" m²



ZELLIGE GREY
6,2 x 25 (G 27) 2,5" x 10" m²



ZELLIGE ANTIQUE
6,2 x 25 (G 27) 2,5" x 10" m²



ZELLIGE ROSE
6,2 x 25 (G 27) 2,5" x 10" m²



ZELLIGE GREEN
6,2 x 25 (G 27) 2,5" x 10" m²



ZELLIGE BLUE
6,2 x 25 (G 27) 2,5" x 10" m²



ZELLIGE BLACK
6,2 x 25 (G 27) 2,5" x 10" m²

PACKING BASES

FORMATO	PULGADAS	PZ/CAJA	M ²	CAJA/PLT	PESO/CAJA	PESO/PLT
6,2 x 25	2,5" x 10"	32	0,5	138	7,46	1.045

CONVEX MIX

Pasta Blanca

REVESTIMIENTO
WALL TILE

SUPERFICIE BRILLO
SURFACE BRIGTNES

VOLUMEN
VOLUME

FORMATOS:
5 x 25 - 2" x 10"



MATE - MATT



BRILLO - GLOSSY



CONVEX CALÇ MATT
5 x 25 (G 60) 2" x 10" m²



CONVEX CALÇ
5 x 25 (G 60) 2" x 10" m²

BRILLO - GLOSSY



CONVEX ROSE MIX
5 x 25 (G 60) 2" x 10" m²



CONVEX ACQUA MIX
5 x 25 (G 60) 2" x 10" m²



CONVEX ASH MIX
5 x 25 (G 60) 2" x 10" m²



CONVEX TURCHESE MIX
5 x 25 (G 60) 2" x 10" m²



CONVEX GREY MIX
5 x 25 (G 60) 2" x 10" m²



CONVEX OLIVE MIX
5 x 25 (G 60) 2" x 10" m²

PACKING BASES

FORMATO	PULGADAS	PZ/CAJA	M ²	CAJA/PLT	PESO/CAJA	PESO/PLT
CONVEX MIX 5 x 25	2" x 10"	54	0,675	33	14,18	483

Piastrella MIX

Pasta Blanca

REVESTIMIENTO
WALL TILE
SUPERFICIE BRILLO
SURFACE BRIGHTNESS

DESTONIFICADO ARMONIOSO
CONTROLLED DESTONIFICATION
BORDES Y SUPERFICIE IRREGULAR
IRREGULAR EDGES AND SURFACE

FORMATOS:
5 x 25 - 2" x 10"
5 x 50 - 2" x 20"
15 x 50 - 6" x 20"



BRILLO · GLOSSY



PIASTRELLA MIX BONE
5 x 25 (G 27) 2" x 10"



PIASTRELLA MIX ASH
5 x 25 (G 27) 2" x 10"



PIASTRELLA MIX ACQUA
5 x 25 (G 27) 2" x 10"



PIASTRELLA MIX OLIVE
5 x 25 (G 27) 2" x 10"



PIASTRELLA MIX CAPUCHINO
5 x 25 (G 27) 2" x 10"



PIASTRELLA MIX ROSE
5 x 25 (G 27) 2" x 10"



PIASTRELLA MIX TURCHESE
5 x 25 (G 27) 2" x 10"



PIASTRELLA MIX GREY
5 x 25 (G 27) 2" x 10"

PIEZAS ESPECIALES · SPECIAL PIECES

Disponibles en todos los colores · Available in all colors

DEMI-BULLNOSE
1,5 x 30 (G 07) 0,6" x 11,8"

PACKING BASES

FORMATO	PULGADAS	PZ/CAJA	M ²	CAJA/PLT	PESO/CAJA	PESO/PLT
5 x 25	2" x 10"	96	1,2	60	19,3	1.172
15 x 50	6" x 20"	16	1,2	60	19,25	1.169
5 x 50	2" x 20"	48	1,2	60	19,06	1.158

PACKING PIEZAS ESPECIALES

FORMATO	PULGADAS	PZ/CAJA	ML	CAJA/PLT	PESO/CAJA	PESO/PLT
DEMI-BULLNOSE 1,5 x 30	0,6" x 12"	50	15	120	2,2	276

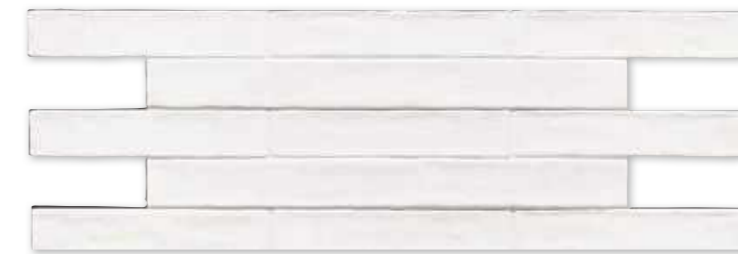

PIASTRELLA NATURALE
5 x 25 (G 27) 2" x 10"
5 x 50 (G 27) 2" x 20"
15 x 50 (G 39) 6" x 20"

Chic

Pasta
Blanca

White
Body

REVESTIMIENTO
WALL TILE

SIN MANTENIMIENTO
NO MAINTENANCE

SUPERFICIE BRILLO
SURFACE BRIGTHNESS

SUPERFICIE MATE
MATT SURFACE

FORMATO
6,4 x 26 - 2,5" x 10,2"



BRILLO - GLOSSY



MATE - MATT



CHIC CREAM
6,4 x 26 (G 56) 2,5" x 10,2"



CHIC SILVER
6,4 x 26 (G 56) 2,5" x 10,2"



CHIC COTTON
6,4 x 26 (G 56) 2,5" x 10,2"



CHIC COTTON MATT
6,4 x 26 (G 56) 2,5" x 10,2"



CHIC SMOKE
6,4 x 26 (G 56) 2,5" x 10,2"



CHIC ROSE
6,4 x 26 (G 56) 2,5" x 10,2"



CHIC SKY
6,4 x 26 (G 56) 2,5" x 10,2"



CHIC SKY MATT
6,4 x 26 (G 56) 2,5" x 10,2"



CHIC GREY
6,4 x 26 (G 56) 2,5" x 10,2"



CHIC GREY MATT
6,4 x 26 (G 56) 2,5" x 10,2"

PIEZAS ESPECIALES - SPECIAL PIECES

Disponibles en todos los colores - Available in all colors

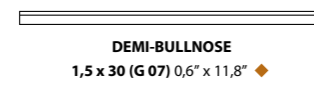

DEMI-BULLNOSE
1,5 x 30 (G 07) 0,6" x 11,8"

PACKING BASES

FORMATO	PULGADAS	PZ/CAJA	M ²	CAJA/PLT	PESO/CAJA	PESO/PLT
6,4 x 26	2,5" x 10,2"	30	0,5	138	7,7	1,077

PACKING PIEZAS ESPECIALES

FORMATO	PULGADAS	PZ/CAJA	ML	CAJA/PLT	PESO/CAJA	PESO/PLT
DEMI-BULLNOSE 1,5 x 30	0,6" x 11,8"	50	15	120	2,2	276

Atelier

Pasta
Blanca

White
Body

REVESTIMIENTO
WALL TILE

BORDES Y SUPERFICIE IRREGULAR
IRREGULAR EDGES AND SURFACE

SUPERFICIE BRILLO
SURFACE BRIGTHNESS

SUPERFICIE MATE
MATT SURFACE

FORMATOS

5 x 25 - 2" x 10"
7,5 x 30 - 3" x 12"
7,5 x 15 - 3" x 6"
10 x 10 - 4" x 4"
15 x 15 - 6" x 6"



BRILLO - GLOSSY



ATELIER OLD WHITE
5 x 25 (G 59) 2" x 10"



ATELIER ANTIQUE
5 x 25 (G 29) 2" x 10"



ATELIER COTTON
5 x 25 (G 27) 2" x 10"



ATELIER SILVER
5 x 25 (G 27) 2" x 10"



ATELIER ANTIQUE
10 x 10 (G 59) 4" x 4"



ATELIER ANTIQUE
7,5 x 15 (G 59) 3" x 6"



ATELIER ANTIQUE
7,5 x 30 (G 27) 3" x 12"



ATELIER LLOMA ANTIQUE
15 x 15 (G 59) 6" x 6"



ATELIER OLD ROSE
5 x 25 (G 59) 2" x 10"



ATELIER OLD BLUE
5 x 25 (G 59) 2" x 10"

PIEZAS ESPECIALES - SPECIAL PIECES

Disponibles en todos los colores - Availables in all colors

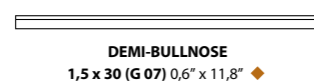

DEMI-BULLNOSE
1,5 x 30 (G 07) 0,6" x 11,8"

PACKING BASES

FORMATO	PULGADAS	PZ/CAJA	M²	CAJA/PLT	PESO/CAJA	PESO/PLT
5 x 25	2" x 10"	96	1,2	60	19,3	1.172
7,5 x 15	3" x 6"	44	0,5	120	8,5	1.034
7,5 x 30	3" x 12"	22	0,5	120	8,5	1.034
15 x 15	6" x 6"	22	0,5	80	9,2	751
10 x 10	4" x 4"	56	0,56	112	8,32	935

PACKING PIEZAS ESPECIALES

FORMATO	PULGADAS	PZ/CAJA	ML	CAJA/PLT	PESO/CAJA	PESO/PLT	
DEMI BULLNOSE	1,5 x 30	0,6" x 12"	50	15	120	2,2	276

MATE - MATT







ATELIER COTTON MATT
5 x 25 (G 27) 2" x 10"



ATELIER GREY MATT
5 x 25 (G 27) 2" x 10"

MANHATTAN

Pasta Blanca

-  SUPERFICIE BRILLO
SURFACE BRIGTNES
-  REVESTIMIENTO
WALL TILE
-  SUPERFICIE MATE
MATT SURFACE
-  MODULARIDAD
MODULARITY
-  BORDES Y SUPERFICIE IRREGULAR
IRREGULAR EDGES AND SUFACE

FORMATOS:
7,5 x 15 - 3" x 6"
7,5 x 30 - 3" x 12"



MATE · MATT



BRILLO · GLOSSY



PIEZAS ESPECIALES · SPECIAL PIECES

Disponibles en todos los colores · Available in all colors





DEMI-BULLNOSE
1,5 x 30 (G 07) 0,6" x 11,8" ◆

PACKING BASES

FORMATO	PULGADAS	PZ/CAJA	M ²	CAJA/PLT	PESO/CAJA	PESO/PLT
7,5 x 30	3" x 12"	22	0,5	120	8,5	1.034
7,5 x 15	3" x 6"	44	0,5	120	8,5	1.034

PACKING PIEZAS ESPECIALES

FORMATO	PULGADAS	PZ/CAJA	ML	CAJA/PLT	PESO/CAJA
1,5 x 30	0,6" x 12"	50	15	120	2,2

-  SUPERFICIE BRILLO
SURFACE BRIGHTNESS
-  REVESTIMIENTO
WALL TILE
-  SUPERFICIE MATE
MATT SURFACE
-  MODULARIDAD
MODULARITY
-  BORDES Y SUPERFICIE IRREGULAR
IRREGULAR EDGES AND SURFACE

FORMATOS:
7,5 x 30 - 3" x 12"
7,5 x 15 - 3" x 6"



MATE · MATT

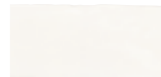

COTSWOLD MATE BIANCO
7,5 x 15 (G 27) 3" x 6" 



COTSWOLD MATE BIANCO
7,5 x 30 (G 39) 3" x 12" 



COTSWOLD MATE NERO
7,5 x 15 (G 27) 3" x 6" 



COTSWOLD MATE NERO
7,5 x 30 (G 39) 3" x 12" 

BRILLO · GLOSSY



COTSWOLD BIANCO
7,5 x 15 (G 27) 3" x 6" 



COTSWOLD BONE
7,5 x 15 (G 27) 3" x 6" 



COTSWOLD BIANCO
7,5 x 30 (G 39) 3" x 12" 



COTSWOLD BONE
7,5 x 30 (G 39) 3" x 12" 



COTSWOLD NERO
7,5 x 15 (G 27) 3" x 6" 



COTSWOLD LATE
7,5 x 15 (G 27) 3" x 6" 



COTSWOLD NERO
7,5 x 30 (G 39) 3" x 12" 



COTSWOLD LATE
7,5 x 30 (G 39) 3" x 12" 



COTSWOLD SAGE
7,5 x 15 (G 27) 3" x 6" 



COTSWOLD ACQUA
7,5 x 15 (G 27) 3" x 6" 



COTSWOLD GREY
7,5 x 15 (G 27) 3" x 6" 



COTSWOLD SAGE
7,5 x 30 (G 39) 3" x 12" 



COTSWOLD ACQUA
7,5 x 30 (G 39) 3" x 12" 



COTSWOLD GREY
7,5 x 30 (G 39) 3" x 12" 



COTSWOLD CAPUCHINO
7,5 x 15 (G 27) 3" x 6" 



COTSWOLD TEAL
7,5 x 15 (G 27) 3" x 6" 



COTSWOLD GRAFITO
7,5 x 15 (G 27) 3" x 6" 



COTSWOLD CAPUCHINO
7,5 x 30 (G 39) 3" x 12" 



COTSWOLD TEAL
7,5 x 30 (G 39) 3" x 12" 



COTSWOLD GRAFITO
7,5 x 30 (G 39) 3" x 12" 

PIEZAS ESPECIALES · SPECIAL PIECES

Disponibles en todos los colores · Available in all colors



PACKING BASES

FORMATO	PULGADAS	PZ/CAJA	M ²	CAJA/PLT	PESO/CAJA	PESO/PLT
7,5 x 30	3" x 12"	22	0,5	120	8,5	1.034
7,5 x 15	3" x 6"	44	0,5	120	8,5	1.034

PACKING PIEZAS ESPECIALES

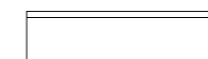
FORMATO	PULGADAS	PZ/CAJA	ML	CAJA/PLT	PESO/CAJA
ZÓCALO 7,5 x 15	3" x 6"	44	6,6	120	7,6
ZÓCALO 7,5 x 30	3" x 12"	22	6,6	120	10,38
V-CAP 5 x 30	3" x 12"	20	6	84	5
ESQUINA V-CAP 3 x 5	1,2" x 2"	25	1,25	56	0,73
DEMI-BULLNOSE 1,5 x 30	0,6" x 12"	50	15	120	2,2



ZÓCALO/BULLNOSE COTSWOLD
7,5 x 30 (G 10) 3" x 12" 
7,5 x 15 (G 06) 3" x 6" 

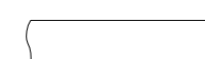

V-CAP COTSWOLD
5 x 30 (G 31) 3" x 12" 



ESQUINA V-CAP COTSWOLD
3 x 5 (G 10) 1,2" x 2" 



DEMI-BULLNOSE
1,5 x 30 (G 07) 0,6" x 12" 

NORDIK

Comfort floor
EVOLUTION
EXTRUDED PORCELAIN TILE

RESISTE LA FLEXIÓN 32 N/mm2	RESISTE EL DESGASTE PEI (II-IV)	RESISTE EL RAYADO MOHS - 4	ANTIDESLIZANTE Class II	MANCHAS Class 5 - Class A	ABSORCIÓN 0,3%	DILATACIÓN 6,6° 10°/°C
--------------------------------	------------------------------------	-------------------------------	----------------------------	------------------------------	-------------------	---------------------------

FORMATO
7 x 36 - 3" x 14"

GRES EXTRUS. PORCELÁNICO PORCELAIN EXTRUS. TILE	PAVIMENTO DE INTERIOR INDOOR FLOOR TILE	REVESTIMIENTO WALL TILE	SUPERFICIE MATE SURFACE MATT	RES. A ÁCIDOS Y BASES RES. TO ACIDS AND BASES	RES. A LA HELADA FROST PROOF	DESTONIFICADO ARMONIOSO CONTROLLED DESTONIFICATION	SIN MANTENIMIENTO NO MAINTENANCE
--	--	-------------------------	---------------------------------	--	---------------------------------	---	-------------------------------------



COLORES · COLORS

Comfort floor ▶ Class II



NORDIK ROPE
7 x 36 (G 39) 3" x 14" m



NORDIK TAN
7 x 36 (G 39) 3" x 14" m

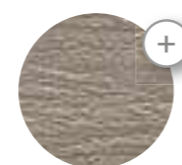

NORDIK CHESNUT
7 x 36 (G 39) 3" x 14" m

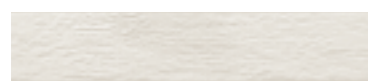
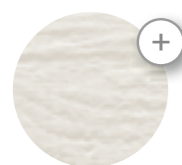

NORDIK FIORD
7 x 36 (G 39) 3" x 14" m



NORDIK ALUMINIUM
7 x 36 (G 39) 3" x 14" m

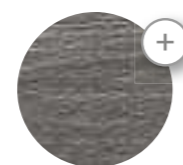

NORDIK SMOKE
7 x 36 (G 39) 3" x 14" m

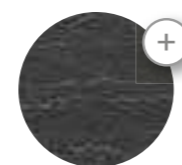

NORDIK GRAPHITE
7 x 36 (G 39) 3" x 14" m



PACKING BASES

FORMATO	PULGADAS	PZ/CAJA	M²	CAJA/PLT	PESO/CAJA	PESO/PLT
7 x 36	3" x 14"	40	1	72	22,94	1,675

Regles















EVOLUTION
EXTRUDED PORCELAIN TILE

-  REVESTIMIENTO WALL TILE
-  SUPERFICIE BRILLO SURFACE BRIGHTNESS
-  VOLUMEN VOLUME













FORMATOS:
7,2 x 22,2 - 3" x 8,5"
15 x 25 - 6" x 10"

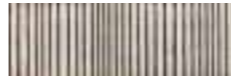

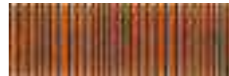
COLORES · COLORS

 REGLES WHITE 7,2 x 22,2 (G 62) 3" x 8,5" m ²	 REGLES BEIGE 7,2 x 22,2 (G 62) 3" x 8,5" m ²	 REGLES IVORY 7,2 x 22,2 (G 62) 3" x 8,5" m ²	 REGLES ASH 7,2 x 22,2 (G 62) 3" x 8,5" m ²	
 REGLES TREND WHITE 7,2 x 22,2 (G 42) 3" x 8,5" m ²	 REGLES TREND CREAM 7,2 x 22,2 (G 42) 3" x 8,5" m ²	 REGLES TREND IVORY 7,2 x 22,2 (G 42) 3" x 8,5" m ²	 REGLES TREND STORM 7,2 x 22,2 (G 42) 3" x 8,5" m ²	 REGLES TREND SKY 7,2 x 22,2 (G 42) 3" x 8,5" m ²
 REGLES GREEN 7,2 x 22,2 (G 62) 3" x 8,5" m ²	 REGLES RED 7,2 x 22,2 (G 62) 3" x 8,5" m ²	 REGLES BLUE 7,2 x 22,2 (G 62) 3" x 8,5" m ²		
 REGLES TREND GREEN 7,2 x 22,2 (G 42) 3" x 8,5" m ²	 REGLES TREND RED 7,2 x 22,2 (G 42) 3" x 8,5" m ²	 REGLES TREND BLUE 7,2 x 22,2 (G 42) 3" x 8,5" m ²		

COLORES TOP · COLORS TOP

 REGLES TOP TITANI 15 x 25 (G 18) 6" x 10" ◆	 REGLES TOP TABAC 15 x 25 (G 18) 6" x 10" ◆	 REGLES TOP CAQUI 15 x 25 (G 18) 6" x 10" ◆	 REGLES TOP VERMELL 15 x 25 (G 18) 6" x 10" ◆
 REGLES TOP TITANI 7,2 x 22,2 (G 12) 3" x 8,5" ◆	 REGLES TOP TABAC 7,2 x 22,2 (G 12) 3" x 8,5" ◆	 REGLES TOP CAQUI 7,2 x 22,2 (G 12) 3" x 8,5" ◆	 REGLES TOP VERMELL 7,2 x 22,2 (G 12) 3" x 8,5" ◆
 REGLES TOP MENTA 15 x 25 (G 18) 6" x 10" ◆	 REGLES TOP TURQUESA 15 x 25 (G 18) 6" x 10" ◆		
 REGLES TOP MENTA 7,2 x 22,2 (G 12) 3" x 8,5" ◆	 REGLES TOP TURQUESA 7,2 x 22,2 (G 12) 3" x 8,5" ◆	 REGLES TOP COBALTO 7,2 x 22,2 (G 12) 3" x 8,5" ◆	

PACKING BASES

FORMATO	PULGADAS	PZ/CAJA	M ² /CAJA	ML	CAJA/PLT	PESO/CAJA	PESO/PLT
REGLES 15 x 25	6" x 10"	20	0,75	5	60	17,4	1,058
REGLES 7,2 x 22,2	3" x 8,5"	50	0,843	11,1	60	16,55	1,007

LONDON

Pasta Blanca

-  REVESTIMIENTO WALL TILE
-  SUPERFICIE BRILLO SURFACE BRIGHTNESS
-  SUPERFICIE MATE MATT SURFACE

FORMATO:
7,2 x 22,2 - 3" x 8,7"



MATE · MATT



LONDON CITY WHITE MATT
7,2 x 22,2 (G 42) 3" x 8,7" m



LONDON WHITE MATT
7,2 x 22,2 (G 58) 3" x 8,7" m

BRILLO · GLOSSY



LONDON VICTORIA WHITE
7,2 x 22,2 (G 42) 3" x 8,7" m



LONDON CANEM BONE
7,2 x 22,2 (G 42) 3" x 8,7" m



LONDON CIRCUS SAGE
7,2 x 22,2 (G 42) 3" x 8,7" m



LONDON PICADILLY CEMENT
7,2 x 22,2 (G 42) 3" x 8,7" m



LONDON ROYAL RAIN
7,2 x 22,2 (G 42) 3" x 8,7" m

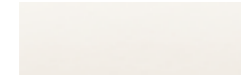

LONDON WHITE
7,2 x 22,2 (G 58) 3" x 8,7" m



LONDON BONE
7,2 x 22,2 (G 58) 3" x 8,7" m

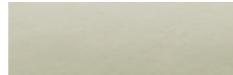

LONDON SAGE
7,2 x 22,2 (G 58) 3" x 8,7" m



LONDON CEMENT
7,2 x 22,2 (G 58) 3" x 8,7" m



LONDON RAIN
7,2 x 22,2 (G 58) 3" x 8,7" m



LONDON COAL
7,2 x 22,2 (G 58) 3" x 8,7" m



LONDON OLIVE
7,2 x 22,2 (G 58) 3" x 8,7" m



LONDON JEANS
7,2 x 22,2 (G 58) 3" x 8,7" m



LONDON MINT
7,2 x 22,2 (G 58) 3" x 8,7" m

PIEZAS ESPECIALES · SPECIAL PIECES

Disponible en todos los colores
Available in all colours

DEMI-BULLNOSE
1,5 x 30 (G 07) 0,6" x 12" ◆

ZÓCALO
7,2 x 22,2 (G 10) 3" x 8,7" ◆

CORNER
10,1 x 7,2 x 5,3 (G 16) 4" x 3" x 2" ◆

LONDON V-CAP
5 x 22,2 (G 13) 2" x 8,7" ◆

PACKING BASES

FORMATO	PULGADAS	PZ/CAJA	M ²	ML	CAJA/PLT	PESO/CAJA	PESO/PLT
7,2 x 22,2	3" x 8,7"	30	0,48	-	120	7,66	935

PACKING PIEZAS ESPECIALES

FORMATO	PULGADAS	PZ/CAJA	ML	CAJA/PLT	PESO/CAJA	PESO/PLT
DEMI-BULLNOSE 1,5 x 30	0,6" x 12"	50	15	120	2,2	276
ZÓCALO 7,2 x 22,2	3" x 8,7"	30	6,66	120	7,66	935
V-CAP 5 x 22,2	2" x 8,7"	20	4,5	-	4,6	-
CORNER 10,1 x 7,2 x 5,3	4" x 3" x 2"	20	2	-	3,75	-



QUATER

Pasta Blanca

SUPERFICIE BRILLO
SURFACE BRIGTHNESS

REVESTIMIENTO
WALL TILE

FORMATO:
7,5 x 15 - 3" x 6"

CONVEX

Pasta Blanca

REVESTIMIENTO
WALL TILE

SUPERFICIE BRILLO
SURFACE BRIGTHNESS

VOLUMEN
VOLUME

MODULARIDAD
MODULARITY

FORMATOS:
5 x 25 - 2" x 10"



BRILLO · GLOSSY

SUPERFICIE CRAQUELADA · CRACKLE SURFACE



QUATER DECO COTTON
7,5 x 15 (G 62) 3" x 6" m



QUATER DECO ÉCRU
7,5 x 15 (G 62) 3" x 6" m

4 TEXTURAS DIFERENTES
4 DIFFERENT TEXTURES

Disponibles en Cotton y Écru
Available in Cotton & Écru



QUATER COTTON
7,5 x 15 (G 60) 3" x 6" m



QUATER ÉCRU
7,5 x 15 (G 60) 3" x 6" m



QUATER CITRON
7,5 x 15 (G 60) 3" x 6" m



QUATER HERBE
7,5 x 15 (G 60) 3" x 6" m



QUATER MER
7,5 x 15 (G 60) 3" x 6" m

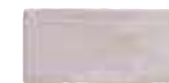

QUATER FUCHSIA
7,5 x 15 (G 60) 3" x 6" m



QUATER CENDRE
7,5 x 15 (G 60) 3" x 6" m



QUATER CHARBON
7,5 x 15 (G 60) 3" x 6" m

BASE · BASE



CONVEX CALÇ
5 x 25 (G 60) 2" x 10" m



CONVEX ARENA
5 x 25 (G 06) 2" x 10" ◆



CONVEX CAMEL
5 x 25 (G 06) 2" x 10" ◆



CONVEX VERMELL
5 x 25 (G 06) 2" x 10" ◆



CONVEX TABAC
5 x 25 (G 06) 2" x 10" ◆



CONVEX TEXÀ
5 x 25 (G 06) 2" x 10" ◆



CONVEX MENTA
5 x 25 (G 06) 2" x 10" ◆



CONVEX MARI
5 x 25 (G 06) 2" x 10" ◆

PIEZAS ESPECIALES · SPECIAL PIECES

Disponibles en todos los colores · Available in all colors

DEMI-BULLNOSE
1,5 x 30 (G 07) 0,6" x 11,8" ◆

PACKING BASES

FORMATO	PULGADAS	PZ/CAJA	M ²	CAJA/PLT	PESO/CAJA	PESO/PLT
7,5 x 15	3" x 6"	44	0,5	120	8,5	1.034
DECOR 7,5 x 15	3" x 6"	44	0,5	120	8,5	1.034

PACKING PIEZAS ESPECIALES

FORMATO	PULGADAS	PZ/CAJA	ML	CAJA/PLT	PESO/CAJA
1,5 x 30	0,6" x 12"	50	15	120	2,2

PACKING BASES

FORMATO	PULGADAS	PZ/CAJA	M ²	CAJA/PLT	PESO/CAJA	PESO/PLT
CONVEX 5 x 25	2" x 10"	54	0,675	33	14,18	483

POOL

PORCELÁNICO
PORCELAIN TILE

ANTI-BACTERIAL

SUPERFICIE BRILLO
SURFACE BRIGHTNESS

REVESTIMIENTO
WALL TILE

RESIST. A LA HELADA
FROST PROOF

SIN MANTENIMIENTO
NO MAINTENANCE

FORMATO

10 x 10 - 4" x 4"
ENM. 30,5 x 30,5 - 11,8" x 11,8"



COLORES DESTONIFICADOS - DESTONIFIED COLORS

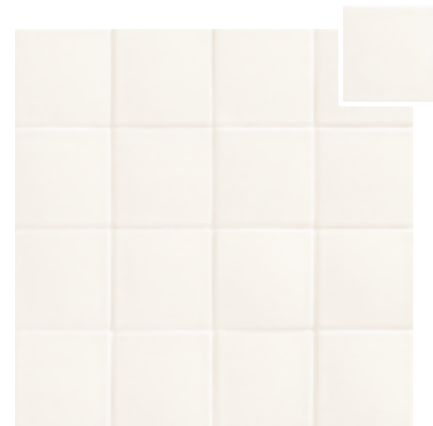

POOL PORC. LUZ
10 x 10 (G 27) 4" x 4" m²
ENM. 30,5 x 30,5 (G 42) 11,8" x 11,8" m²



POOL PORC. CLOUD
10 x 10 (G 27) 4" x 4" m²
ENM. 30,5 x 30,5 (G 42) 11,8" x 11,8" m²



POOL PORC. IRON
10 x 10 (G 27) 4" x 4" m²
ENM. 30,5 x 30,5 (G 42) 11,8" x 11,8" m²



POOL PORC. ROJO
10 x 10 (G 27) 4" x 4" m²
ENM. 30,5 x 30,5 (G 42) 11,8" x 11,8" m²



POOL PORC. EMERALD
10 x 10 (G 27) 4" x 4" m²
ENM. 30,5 x 30,5 (G 42) 11,8" x 11,8" m²

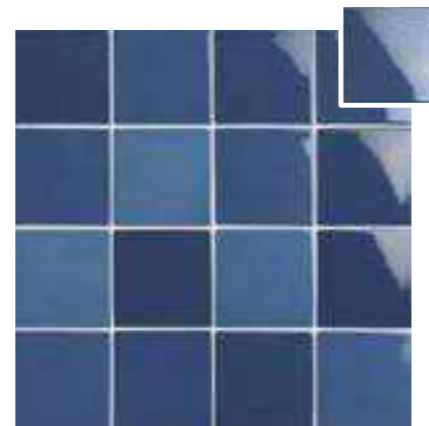

POOL PORC. INDIGO
10 x 10 (G 27) 4" x 4" m²
ENM. 30,5 x 30,5 (G 42) 11,8" x 11,8" m²

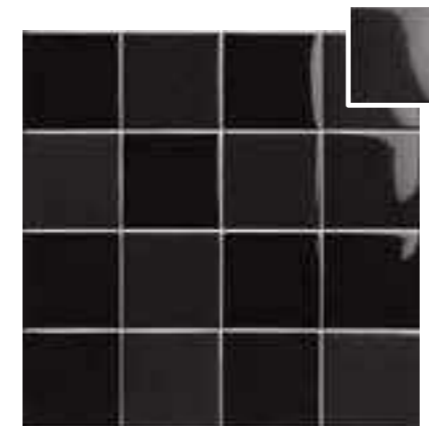

POOL PORC. NEGRO
10 x 10 (G 27) 4" x 4" m²
ENM. 30,5 x 30,5 (G 42) 11,8" x 11,8" m²

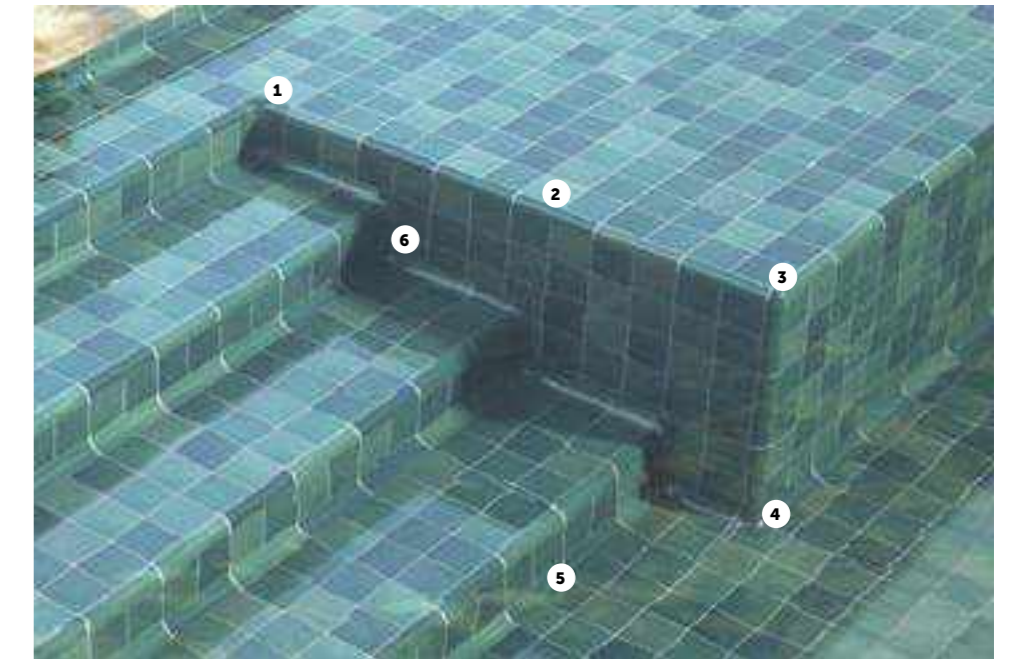

PIEZAS ESPECIALES - SPECIAL PIECES Disponibles en todos los colores - Available in all colors

- 1 COMP. INT. CUBRECANTO 3 x 3 (G 16) 1" x 1" ♦
- 2 CUBRECANTO 3 x 20 x 3 (G 07) 1" x 8" x 1" ♦
- 3 COMP. EXT. CUBRECANTO 3 x 3 (G 12) 1" x 1" ♦
- 4 COMP. EXT. MEDIA CAÑA 3 x 3 (G 16) 1" x 1" ♦
- 5 MEDIA CAÑA INT. 3 x 20 x 3 (G 07) 1" x 8" x 1" ♦
- 6 COMP. INT. MEDIA CAÑA 3 x 3 (G 12) 1" x 1" ♦

PACKING BASES

FORMATO	PULGADAS	PZ/CAJA	M²	CAJA/PLT	PESO/CAJA	PESO/PLT
10 x 10	4" x 4"	50	0,5	120	10,5	1,275
ENM. 30,5 x 30,5	11,8" x 11,8"	11	1,02	60	22	1,335

PACKING PIEZAS ESPECIALES



FORMATO	PULGADAS	PZ/CAJA	ML	CAJA/PLT	PESO/CAJA	PESO/PLT
MEDIA CAÑA INT. 3 x 20 x 3	1" x 8" x 1"	36	7,2	196	1,98	405
COMP. INT. MEDIA CAÑA 3 x 3	1" x 1"	100	3	196	0,85	182
COMP. EXT. MEDIA CAÑA 3 x 3	1" x 1"	100	3	196	1,6	310

PACKING PIEZAS ESPECIALES

FORMATO	PULGADAS	PZ/CAJA	ML	CAJA/PLT	PESO/CAJA	PESO/PLT
CUBRECANTO 3 x 20 x 3	1" x 8" x 1"	36	7,2	196	1,98	405
COMP. INT. CUBRECANTO 3 x 3	1" x 1"	100	3	196	1,6	310
COMP. EXT. CUBRECANTO 3 x 3	1" x 1"	100	3	196	0,85	182

STOW

Pasta Blanca

-  REVESTIMIENTO WALL TILE
-  SUPERFICIE BRILLO SURFACE BRIGHTNESS
-  MODULAR MODULARITY

FORMATO
20 x 60 - 8" x 24"
20 x 20 - 8" x 8"
10 x 10 - 4" x 4"



STOW



STOW MIX

COLORES DESTONIFICADOS · DESTONIFIED COLORS



STOW MIX ACQUA
10 x 10 (G 27) 4" x 4" m²

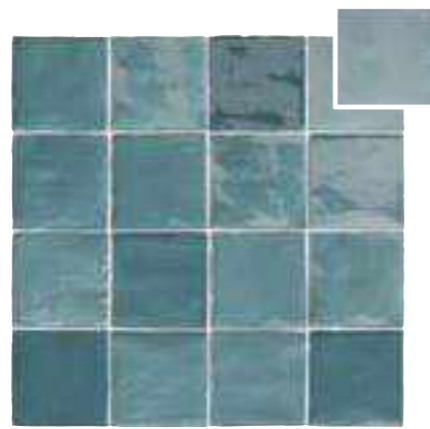

STOW MIX TURCHESE
10 x 10 (G 27) 4" x 4" m²

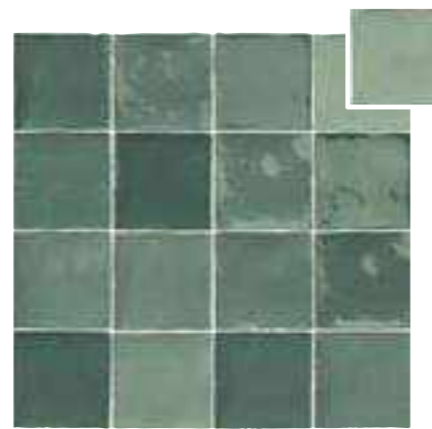

STOW MIX OLIVE
10 x 10 (G 27) 4" x 4" m²



STOW MIX GREY
10 x 10 (G 27) 4" x 4" m²



STOW MIX GRAFFITO
10 x 10 (G 27) 4" x 4" m²

PACKING BASES

FORMATO	PULGADAS	PZ/CAJA	M²	CAJA/PLT	PESO/CAJA	PESO/PLT
10 x 10	4" x 4"	56	0,56	112	8,22	935
20 x 20	8" x 8"	28	1,12	60	16,65	1014
20 x 60	8" x 24"	8	0,96	32	15	495

COLORES · COLORS



STOW BIANCO
20 x 60 (G 27) 8" x 24" m²



STOW BIANCO
20 x 20 (G 56) 8" x 8" m²



STOW BIANCO
10 x 10 (G 27) 4" x 4" m²



STOW BIANCO DECOR
10 x 10 (G 62) 4" x 4" m²



STOW BONE
20 x 60 (G 27) 8" x 24" m²



STOW BONE
20 x 20 (G 56) 8" x 8" m²



STOW BONE
10 x 10 (G 27) 4" x 4" m²



STOW BONE DECOR
10 x 10 (G 62) 4" x 4" m²



STOW CAPUCHINO
20 x 60 (G 27) 8" x 24" m²



STOW CAPUCHINO
20 x 20 (G 56) 8" x 8" m²



STOW CAPUCHINO
10 x 10 (G 27) 4" x 4" m²



STOW CAPUCHINO DECOR
10 x 10 (G 62) 4" x 4" m²



STOW ACQUA
20 x 60 (G 27) 8" x 24" m²



STOW ACQUA
20 x 20 (G 56) 8" x 8" m²



STOW ACQUA
10 x 10 (G 27) 4" x 4" m²



STOW ACQUA DECOR
10 x 10 (G 62) 4" x 4" m²



STOW GREY
20 x 60 (G 27) 8" x 24" m²



STOW GREY
20 x 20 (G 56) 8" x 8" m²



STOW GREY
10 x 10 (G 27) 4" x 4" m²

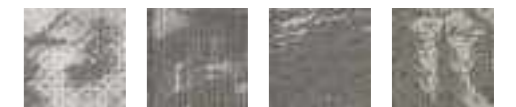

STOW GREY DECOR
10 x 10 (G 62) 4" x 4" m²



STOW GRAFFITO
20 x 60 (G 27) 8" x 24" m²



STOW GRAFFITO
20 x 20 (G 56) 8" x 8" m²



STOW GRAFFITO
10 x 10 (G 27) 4" x 4" m²



STOW GRAFFITO DECOR
10 x 10 (G 62) 4" x 4" m²

4 TEXTURAS DIFERENTES · Se suministran mezclados
4 DIFFERENT TEXTURES · Supplied mixed

Disponibles en Bianco, Bone, Capuchino, Acqua, Grey, Grafito
Available in Bianco, Bone, Capuchino, Acqua, Grey, Grafito

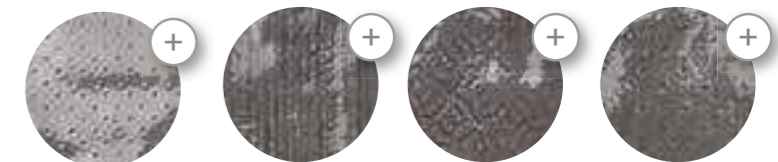

CottoBello



Pasta Blanca
PASTA BLANCA
WHITE BODY

P PORCELÁNICO
PORCELAIN FLOOR

RESIST. A ÁCIDOS Y BASES
RESIST. TO ACIDS & BASES

SUPERFICIE SEMIBRILLO
SURFACE SEMI-GLOSS

PAV. DE INTERIOR
INDOOR FLOOR TILE

SIN MANTENIMIENTO
NO MAINTENANCE

DESTONIFICADO ARMONIOSO
CONTROLLED DESTONIFICATION

FORMATOS
7,5 x 30 - 3" x 12"
7,5 x 15 - 3" x 6"
20 x 20 - 8" x 8"
PAV. 20 x 20 - 8" x 8"



REVESTIMIENTO · WALL TILE

Pasta Blanca

BORDES Y SUPERFICIE IRREGULAR
IRREGULAR EDGES AND SURFACE



+30
DISEÑOS
DIFERENTES



+30
DISEÑOS
DIFERENTES



+30
DISEÑOS
DIFERENTES

SE
SUMINISTRAN
MEZCLADOS

COTTOBELLO PAGLIA
20 x 20 (G 25) 8" x 8" m²

COTTOBELLO TERRA
20 x 20 (G 25) 8" x 8" m²

COTTOBELLO MIX STAMPO TERRA
20 x 20 (G 57) 8" x 8" m²



+30
DISEÑOS
DIFERENTES



+30
DISEÑOS
DIFERENTES

COTTOBELLO PAGLIA
7,5 x 30 (G 56) 3" x 12" m²

COTTOBELLO TERRA
7,5 x 15 (G 39) 3" x 6" m²

PIEZAS ESPECIALES · SPECIAL PIECES
Disponible en PAGLIA · Available in PAGLIA

LISTONE
2 x 20 (G 10) 1" x 8" ◆

ROMO
5 x 20 (G 11) 2" x 8" ◆

PAVIMENTO · FLOOR TILE

Comfort floor

PORCELÁNICO
PORCELAIN FLOOR

BORDES Y SUPERFICIE IRREGULAR
IRREGULAR EDGES AND SURFACE



+30
DISEÑOS
DIFERENTES



+30
DISEÑOS
DIFERENTES

SE
SUMINISTRAN
MEZCLADOS

COTTOBELLO PORC. TERRA
20 x 20 (G 56) 8" x 8" m²

COTTOBELLO PORC. MIX STAMPO TERRA
20 x 20 (G 39) 8" x 8" m²

PACKING BASES REVESTIMIENTO

FORMATO	PULGADAS	PZ/CAJA	M ²	CAJA/PLT	PESO/CAJA	PESO/PLT
20 x 20	8" x 8"	28	1,12	60	16,65	1,014
7,5 x 30	3" x 12"	22	0,5	120	8,5	1,034
7,5 x 15	3" x 6"	44	0,5	120	8,5	1,034

PACKING PIEZAS ESPECIALES

FORMATO	PULGADAS	PZ/CAJA	ML	CAJA/PLT	PESO/CAJA
ROMO 5 x 20	2" x 8"	14	2,8	112	1,94
LISTONE 2 x 20	1" x 8"	42	8,4	112	2,92

REVESTIMIENTO · WALL TILE

Pasta Blanca

BORDES Y SUPERFICIE IRREGULAR
IRREGULAR EDGES AND SURFACE



+30
DISEÑOS
DIFERENTES

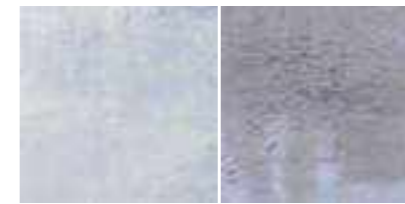

+30
DISEÑOS
DIFERENTES



+30
DISEÑOS
DIFERENTES

SE
SUMINISTRAN
MEZCLADOS

COTTOBELLO BLU
20 x 20 (G 25) 8" x 8" m²

COTTOBELLO AZURRO
20 x 20 (G 25) 8" x 8" m²

COTTOBELLO MIX STAMPO AZURRO
20 x 20 (G 57) 8" x 8" m²



+30
DISEÑOS
DIFERENTES



+30
DISEÑOS
DIFERENTES

COTTOBELLO BLU
7,5 x 30 (G 56) 3" x 12" m²

COTTOBELLO AZURRO
7,5 x 15 (G 39) 3" x 6" m²

PIEZAS ESPECIALES · SPECIAL PIECES
Disponible en BLU · Available in BLU

LISTONE
2 x 20 (G 10) 1" x 8" ◆

ROMO
5 x 20 (G 11) 2" x 8" ◆

PAVIMENTO · FLOOR TILE

Comfort floor

PORCELÁNICO
PORCELAIN FLOOR

BORDES Y SUPERFICIE IRREGULAR
IRREGULAR EDGES AND SURFACE



+30
DISEÑOS
DIFERENTES



+30
DISEÑOS
DIFERENTES

SE
SUMINISTRAN
MEZCLADOS

COTTOBELLO PORC. AZURRO
20 x 20 (G 56) 8" x 8" m²

COTTOBELLO PORC. MIX STAMPO AZURRO
20 x 20 (G 39) 8" x 8" m²

PACKING BASES PAVIMENTO

FORMATO	PULGADAS	PZ/CAJA	M ²	CAJA/PLT	PESO/CAJA	PESO/PLT
20 x 20	8" x 8"	28	1,12	60	20,16	1,225

TEMPO

EVOLUTION
EXTRUDED PORCELAIN TILE

RESISTE LA FLEXIÓN	RESISTE EL DESGASTE	RESISTE EL RAYADO	ANTIDESLIZANTE	MANCHAS	ABSORCIÓN	DILATACIÓN
32 N/m2	PEI (II - V)	MOHS-7	Class I - R9	Class 5 - Class A	<0,3%	5,7" 10" / °C

PAV. DE INTERIOR INDOOR FLOOR TILE	REVESTIMIENTO WALL TILE	SUPERFICIE BRILLO SURFACE BRIGTNES	SIN MANTENIMIENTO NO MAINTENANCE	RES. A ÁCIDOS Y BASES RES. TO ACIDS AND BASES	RES. A LA HELADA FROST PROOF	DESTONIFICADO ARMONIOSO CONTROLLED DESTONIFICATION

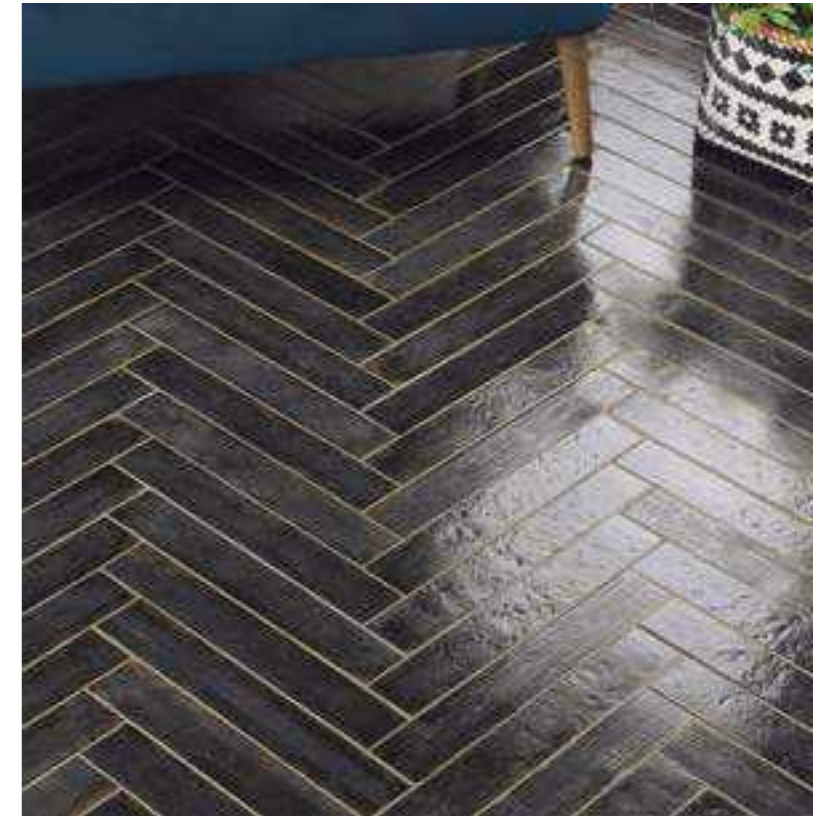

TEMPO SAND 11 x 11 (G 58) 4,3" x 4,3" m ²	TEMPO FOSSIL 11 x 11 (G 58) 4,3" x 4,3" m ²	TEMPO MOSS 11 x 11 (G 58) 4,3" x 4,3" m ²	TEMPO ATLANTIC 11 x 11 (G 58) 4,3" x 4,3" m ²
TEMPO SAND 11 x 22,5 (G 58) 4,3" x 8,8" m ²	TEMPO FOSSIL 11 x 22,5 (G 58) 4,3" x 8,8" m ²	TEMPO MOSS 11 x 22,5 (G 58) 4,3" x 8,8" m ²	TEMPO ATLANTIC 11 x 22,5 (G 58) 4,3" x 8,8" m ²
TEMPO SAND HEX. 18 x 20,5 (G 39) 7" x 8" m ²	TEMPO FOSSIL HEX. 18 x 20,5 (G 39) 7" x 8" m ²	TEMPO FABRIC HEX. 18 x 20,5 (G 55) 7" x 8" m ²	TEMPO MOSS HEX. 18 x 20,5 (G 39) 7" x 8" m ²
TEMPO ATLANTIC HEX. 18 x 20,5 (G 39) 7" x 8" m ²			

TEMPO RICE 11 x 11 (G 58) 4,3" x 4,3" m ²	TEMPO DROP RICE 11 x 11 (G 56) 4,3" x 4,3" m ²	TEMPO CAVIAR 11 x 11 (G 58) 4,3" x 4,3" m ²
TEMPO RICE 11 x 22,5 (G 58) 4,3" x 8,8" m ²	TEMPO SACK RICE 11 x 22,5 (G 56) 4,3" x 8,8" m ²	TEMPO CAVIAR 11 x 22,5 (G 58) 4,3" x 8,8" m ²
TEMPO RICE HEX. 18 x 20,5 (G 39) 7" x 8" m ²	TEMPO BOND RICE HEX. 18 x 20,5 (G 55) 7" x 8" m ²	TEMPO CAVIAR HEX. 18 x 20,5 (G 39) 7" x 8" m ²
TEMPO LINK RICE 7 x 45 (G 59) 3" x 17,7" m ²	TEMPO LINK CAVIAR 7 x 45 (G 59) 3" x 17,7" m ²	
TEMPO RICE 7 x 45 (G 27) 3" x 17,7" m ²	TEMPO CAVIAR 7 x 45 (G 27) 3" x 17,7" m ²	
TEMPO RICE 22,5 x 45 (G 25) 8,8" x 17,7" m ²	TEMPO CAVIAR 22,5 x 45 (G 25) 8,8" x 17,7" m ²	

PIEZAS ESPECIALES - SPECIAL PIECES
Disponibile en todos los colores - Available in all colors

VIERTEAGUAS 15 x 22,5/4 (G 10) 5,9" x 8,8" m ²	DEMI-BULLNOSE 1,5 x 30 (G 07) 0,6" x 12" m ²

DECORACIÓN - DECORATION
Decoración serie TEMPO completa en pág. 72-73 - Complete TEMPO decor on pág. 72-73

11 x 11 (G 56) 4,3" x 4,3" m² Escala reducida

TEMPO MOTIF RICE	TEMPO INCLINE RICE	TEMPO PATTERN SAND

TEMPO OLD MOSS	TEMPO OLD ATLANTIC	TEMPO LINES ATLANTIC	TEMPO LINES CAVIAR

22,5 x 22,5 (G 57) 8,8" x 8,8" m² Escala reducida

TEMPO ROADS ATLANTIC	TEMPO TANGRAM ATLANTIC	TEMPO PATTERN CAVIAR	TEMPO ROADS CAVIAR

PACKING BASES

FORMATO	PULGADAS	PZ/CAJA	M ²	CAJA/PLT	PESO/CAJA	PESO/PLT
11 x 11	4,3" x 4,3"	40	0,5	144	10,15	1491
11 x 22,5	4,3" x 8,8"	20	0,5	144	10,3	1498

PACKING BASES

FORMATO	PULGADAS	PZ/CAJA	M ²	CAJA/PLT	PESO/CAJA	PESO/PLT
22,5 x 45	8,8" x 17,7"	10	1,01	72	21,1	1535
HEX. 18 x 20,5	7" x 8"	36	1	48	21	1025
7 x 45	3" x 17,7"	32	1	60	21,4	1300

PACKING PIEZAS ESPECIALES

FORMATO	PULGADAS	PZ/CAJA	ML	CAJA/PLT	PESO/CAJA	PESO/PLT
VIERTEAGUAS 15 x 22,5/4	5,9" x 8,8"	14	3,15	48	15,08	739
DEMI BULLNOSE 1,5 x 30	0,6" x 12"	50	15	120	2,2	276

TEMPO

EVOLUTION
EXTRUDED PORCELAIN TILE

RESISTE LA FLEXIÓN	RESISTE EL DESGASTE	RESISTE EL RAYADO	ANTIDESLIZANTE	MANCHAS	ABSORCIÓN	DILATACIÓN
32 N/m ²	PEI (II - V)	MOHS - 7	Class I - R9	Class S - Class A	<0,3%	5,7" 10" / °C

PAV. DE INTERIOR INDOOR FLOOR TILE	REVESTIMIENTO WALL TILE	SUPERFICIE BRILLO SURFACE BRIGHTNESS	SIN MANTENIMIENTO NO MAINTENANCE	RES. A ÁCIDOS Y BASES RES. TO ACIDS AND BASES	RES. A LA HELADA FROST PROOF	DESTONIFICADO ARMONIOSO CONTROLLED DESTONIFICATION

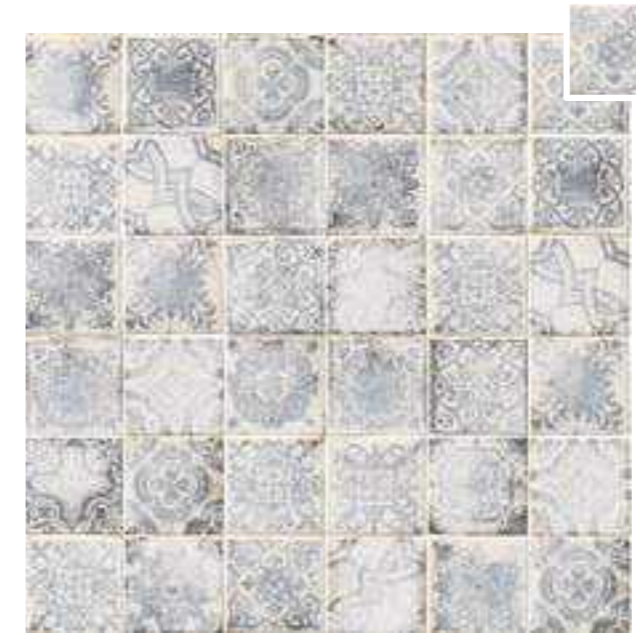

TEMPO OLD ATLANTIC
11 x 11 (G 56) 4,3" x 4,3"



TEMPO LINES ATLANTIC
11 x 11 (G 56) 4,3" x 4,3"



TEMPO OLD MOSS
11 x 11 (G 56) 4,3" x 4,3"

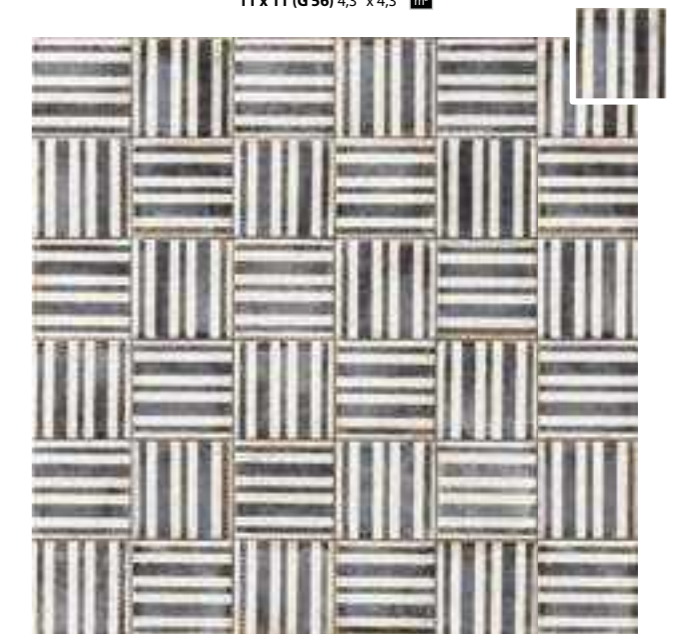

TEMPO LINES CAVIAR
11 x 11 (G 56) 4,3" x 4,3"

DECORACIÓN · DECORATION

La serie TEMPO combina con las bases de la serie TEMPO pág. 134 - 135
TEMPO combines with TEMPO collection, pág. 134 - 135



TEMPO INCLINE RICE
11 x 11 (G 56) 4,3" x 4,3"



TEMPO MOTIF RICE
11 x 11 (G 56) 4,3" x 4,3"



TEMPO PATTERN SAND
11 x 11 (G 56) 4,3" x 4,3"

TEMPO PATTERN SAND PERMITE
MÚLTIPLES POSIBILIDADES
COMPOSITIVAS
TEMPO PATTERN SAND OFFERS
INFINITE COMPOSITE
POSSIBILITIES



PACKING DECOR

FORMATO	PULGADAS	PZ/CAJA	M ²	CAJA/PLT	PESO/CAJA	PESO/PLT
11 x 11	4,3" x 4,3"	40	0,5	144	10,15	1491

TEMPO

EVOLUTION
EXTRUDED PORCELAIN TILE

RESISTE LA FLEXIÓN	RESISTE EL DESGASTE	RESISTE EL RAYADO	ANTIDESLIZANTE	MANCHAS	ABSORCIÓN	DILATACIÓN
32 N/m ²	PEI (II - V)	MOHS - 7	Class I - R9	Class S - Class A	<0,3%	5,7" 10" / °C

PAV. DE INTERIOR INDOOR FLOOR TILE	REVESTIMIENTO WALL TILE	SUPERFICIE BRILLO SURFACE BRIGHTNESS	SIN MANTENIMIENTO NO MAINTENANCE	RES. A ÁCIDOS Y BASES RES. TO ACIDS AND BASES	RES. A LA HELADA FROST PROOF	DESTONIFICADO ARMONIOSO CONTROLLED DESTONIFICATION



DECORACIÓN · DECORATION

La serie TEMPO combina con las bases de la serie TEMPO pág. 32-33
TEMPO combines with TEMPO collection, pág. 32-33

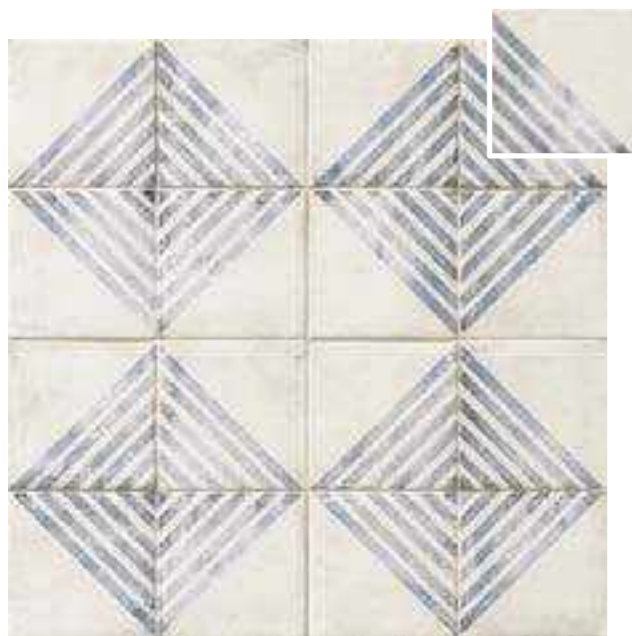

TEMPO ROADS ATLANTIC
22,5 x 22,5 (G 57) 8,8" x 8,8" m



TEMPO TANGRAM ATLANTIC
22,5 x 22,5 (G 57) 8,8" x 8,8" m



TEMPO PATTERN CAVIAR
22,5 x 22,5 (G 57) 8,8" x 8,8" m



TEMPO ROADS CAVIAR
22,5 x 22,5 (G 57) 8,8" x 8,8" m

TEMPO ROADS CAVIAR PERMITE
MÚLTIPLES POSIBILIDADES
COMPOSITIVAS
TEMPO ROADS CAVIAR OFFERS
INFINITE COMPOSITIVE
POSSIBILITIES



PACKING DECOR

FORMATO	PULGADAS	PZ/CAJA	M ²	CAJA/PLT	PESO/CAJA	PESO/PLT
22,5 x 22,5	8,8" x 8,8"	20	1,01	72	20,7	1,505

TECH·COOL

Comfort floor
EVOLUTION
EXTRUDED PORCELAIN TILE

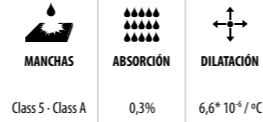

FORMATOS
11 x 22,5 - 4,3" x 8,8"
22,5 x 22,5 - 8,8" x 8,8"
22,5 x 33 - 8,8" x 13"
7 x 60 - 3" x 23,6"
ARROW 7 x 33,5 - 3" x 13,1"
HEX. 18 x 20,5 - 7" x 8"

PE GRÉS EXTRUSIONADO PORCELÁNICO / PORCELAIN EXTRUDED TILE
SUPERFICIE BRILLO / GLOSS SURFACE
PAV. DE INTERIOR / INDOOR FLOOR TILE
SIN MANTENIMIENTO / NO MAINTENANCE
RES. A ÁCIDOS Y BASES / RES. TO ACIDS AND BASES
RES. A LA HELADA / FROST PROOF



BASES · BASE

DECORACIÓN · DECORATION



TECH COOL SNOW HEX.
18 x 20,5 (G 55) 7" x 8" m²



TECH COOL SNOW
11 x 22,5 (G 39) 4,3" x 8,8" m²



TECH COOL ARROW SNOW
7 x 33,5 (G 27) 3" x 13,1" m²



TECH COOL SNOW
22,5 x 33 (G 58) 8,8" x 13" m²

TECH COOL SNOW
22,5 x 22,5 (G 58) 8,8" x 8,8" m²



TECH COOL SNOW
7 x 60 (G 27) 3" x 23,6" m²



TECH COOL CAST SNOW HEX.
18 x 20,5 (G 27) 7" x 8" m²



TECH COOL CAST SNOW
11 x 22,5 (G 55) 4,3" x 8,8" m²



TECH COOL CAST SNOW
7 x 60 (G 59) 3" x 23,6" m²



1 TEXTURA
1 TEXTURE



TECH COOL CAST SNOW
22,5 x 22,5 (G 56) 8,8" x 8,8" m²



TECH COOL CAST ARROW SNOW
7 x 33,5 (G 59) 3" x 13,1" m²

PACKING BASES

FORMATO	PULGADAS	PZ/CAJA	M²	CAJA/PLT	PESO/CAJA	PESO/PLT
HEX. 18 x 20,5	7" x 8"	30	0,83	48	22,57	1.098
11 x 22,5	4,3" x 8,8"	20	0,5	112	13,70	1.550

PACKING BASES

FORMATO	PULGADAS	PZ/CAJA	M²	CAJA/PLT	PESO/CAJA	PESO/PLT
22,5 x 22,5	8,8" x 8,8"	17	0,86	60	23,19	1.406
22,5 x 33	8,8" x 13"	17	0,82	68	23,30	1.506

BASES · BASE

DECORACIÓN · DECORATION



TECH COOL SLATE HEX.
18 x 20,5 (G 55) 7" x 8" m²



TECH COOL SLATE
11 x 22,5 (G 39) 4,3" x 8,8" m²



TECH COOL ARROW SLATE
7 x 33,5 (G 27) 3" x 13,1" m²



TECH COOL SLATE
22,5 x 22,5 (G 58) 8,8" x 8,8" m²



TECH COOL SLATE
7 x 60 (G 27) 3" x 23,6" m²



TECH COOL CAST SLATE HEX.
18 x 20,5 (G 27) 7" x 8" m²



TECH COOL CAST SLATE
11 x 22,5 (G 55) 4,3" x 8,8" m²



TECH COOL CAST SLATE
7 x 60 (G 59) 3" x 23,6" m²

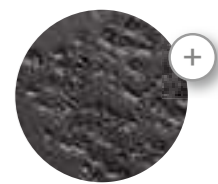

1 TEXTURA
1 TEXTURE



TECH COOL CAST SLATE
22,5 x 22,5 (G 56) 8,8" x 8,8" m²



TECH COOL CAST ARROW SLATE
7 x 33,5 (G 59) 3" x 13,1" m²

PACKING BASES

FORMATO	PULGADAS	PZ/CAJA	M²	CAJA/PLT	PESO/CAJA	PESO/PLT
7 x 33,5	3" x 13,1"	36	0,85	48	23,68	1.152
7 x 60	3" x 23,6"	18	0,76	66	21,96	1.464



BASE - BASE

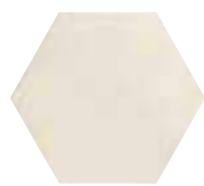

CITY CONCRET HEX. DALLAS
CITY CONCRET HEX. ANTI. DALLAS
18 x 20,5 (G 39) 7" x 8" **ml**



CITY CONCRET HEX. LOS ÁNGELES
CITY CONCRET HEX. ANTI. LOS ÁNGELES
18 x 20,5 (G 39) 7" x 8" **ml**

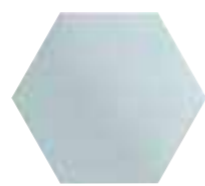

CITY CONCRET HEX. MIAMI
CITY CONCRET HEX. ANTI. MIAMI
18 x 20,5 (G 39) 7" x 8" **ml**



ROMBO CITY CONCRET DALLAS
11 x 18 (G 62) 4,3" x 7" **ml**



ROMBO CITY CONCRET LOS ÁNGELES
11 x 18 (G 62) 4,3" x 7" **ml**

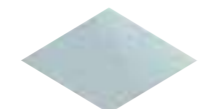

ROMBO CITY CONCRET MIAMI
11 x 18 (G 62) 4,3" x 7" **ml**



CITY CONCRET DALLAS
7 x 45 (G 27) 3" x 17,7" **ml**



CITY CONCRET LOS ÁNGELES
7 x 45 (G 27) 3" x 17,7" **ml**

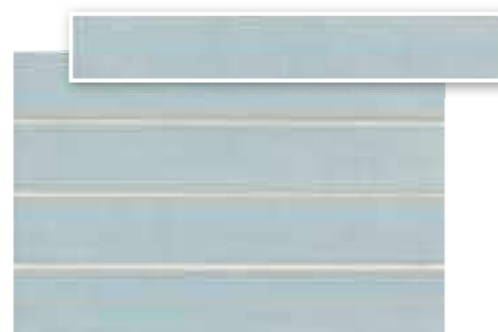

CITY CONCRET MIAMI
7 x 45 (G 27) 3" x 17,7" **ml**



CITY CONCRET HEX. NEW YORK
CITY CONCRET HEX. ANTI. NEW YORK
18 x 20,5 (G 39) 7" x 8" **ml**



ROMBO CITY CONCRET NEW YORK
11 x 18 (G 62) 4,3" x 7" **ml**

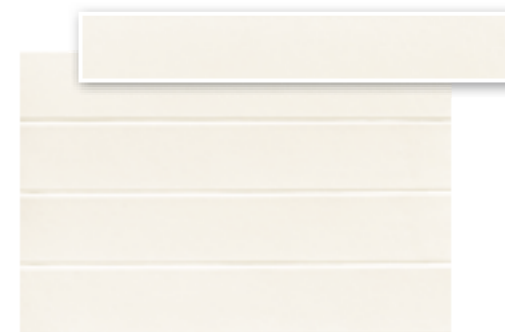

CITY CONCRET NEW YORK
7 x 45 (G 27) 3" x 17,7" **ml**

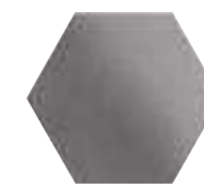

CITY CONCRET HEX. CHICAGO
CITY CONCRET HEX. ANTI. CHICAGO
18 x 20,5 (G 39) 7" x 8" **ml**

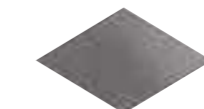

ROMBO CITY CONCRET CHICAGO
11 x 18 (G 62) 4,3" x 7" **ml**

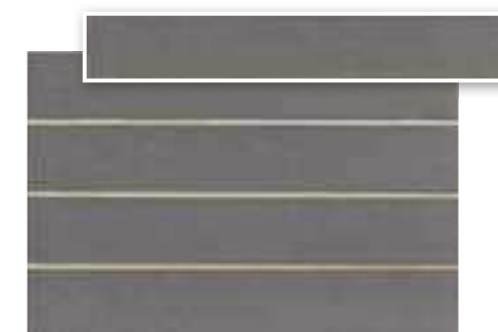

CITY CONCRET CHICAGO
7 x 45 (G 27) 3" x 17,7" **ml**



CITY CONCRET ROAD NEW YORK
7 x 45 (G 59) 3" x 17,7" **ml**



CITY CONCRET ROAD CHICAGO
7 x 45 (G 59) 3" x 17,7" **ml**

DECOR

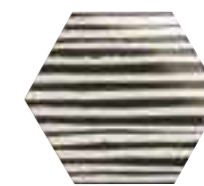

CITY CONCRET PHILADELPIA HEX.
18 x 20,5 (G 39) 7" x 8" **ml**



CITY CONCRET HOUSTON HEX.
18 x 20,5 (G 39) 7" x 8" **ml**



ROMBO CITY CONCRET PHILADELPIA
11 x 18 (G 62) 4,3" x 7" **ml**



ROMBO CITY CONCRET HOUSTON
11 x 18 (G 62) 4,3" x 7" **ml**

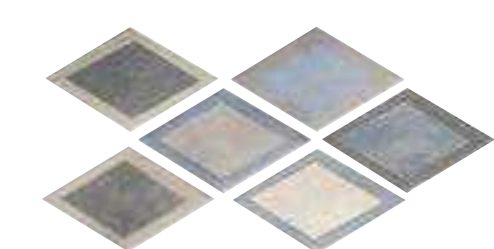

ROMBO CITY CONCRET MENPHIS MIX
11 x 18 (G 62) 4,3" x 7" **ml**

PIEZAS ESPECIALES · SPECIAL PIECES

Disponibles en todos los colores
Availables in all colors

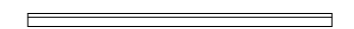

DEMI-BULLNOSE
1,5 x 30 (G 07) 0,6" x 12" **ml**

PACKING BASES

FORMATO	PULGADAS	PZ/CAJA	M ²	CAJA/PLT	PESO/CAJA	PESO/PLT
7 x 45	3" x 17,7"	32	1	60	21,4	1.300
HEX. 18 x 20,5	7" x 8"	36	1	48	21	1.024
ROMBO 11 x 18	4,3" x 7"	50	0,495	108	9,4	1.030

PACKING PIEZAS ESPECIALES

FORMATO	PULGADAS	PZ/CAJA	ML	CAJA/PLT	PESO/CAJA	PESO/PLT
DEMI BULLNOSE 1,5 x 30	0,6" x 12"	50	15	120	2,2	276

CONCRET



FORMATOS:
 9 x 36 - 3,5" x 14"
 HEXAGONO 22,5 x 26 - 9" x 10"
 CHEVRON 11 x 26 - 4" x 10"



COLORES · COLOURS

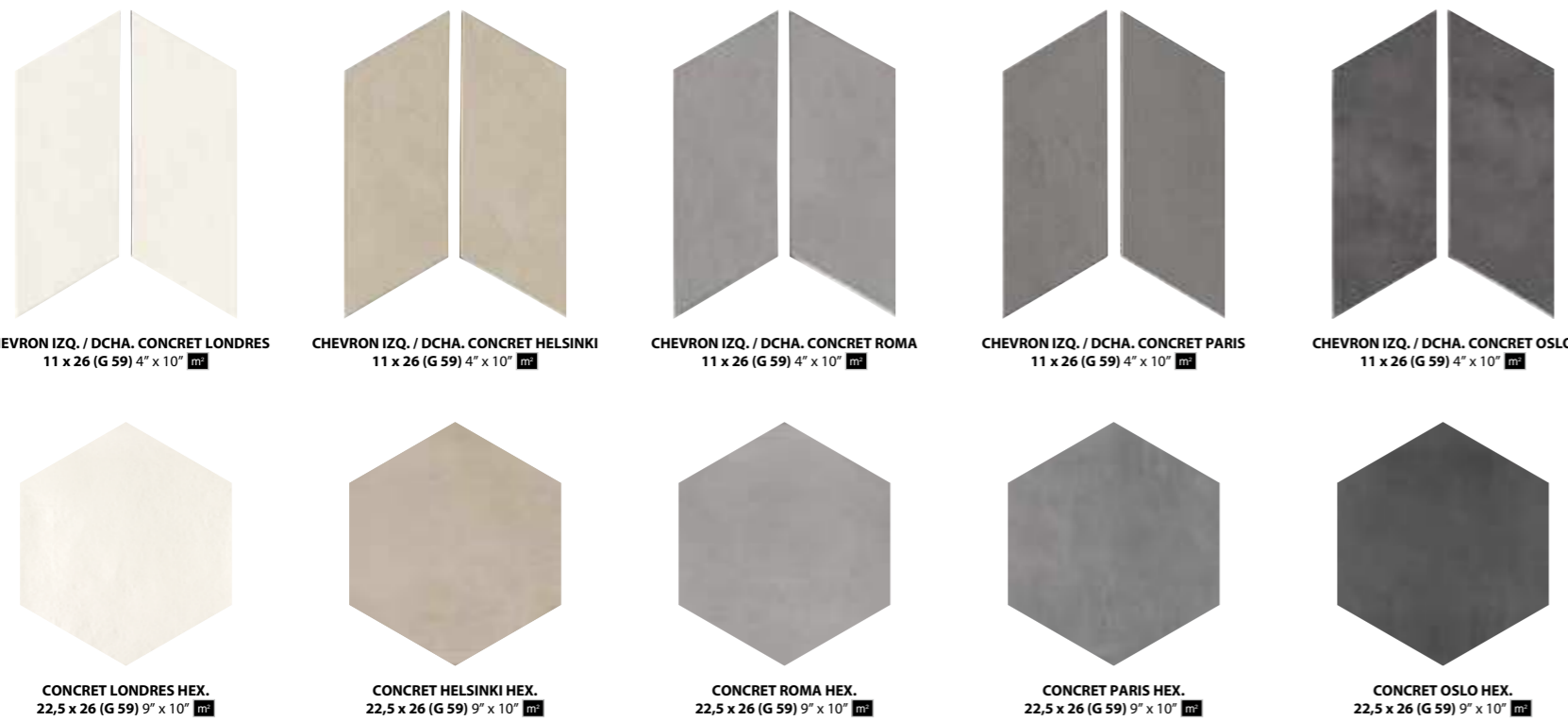

PACKING BASES

FORMATO	PULGADAS	PZ/CAJA	M ²	CAJA/PLT	PESO/CAJA	PESO/PLT
HEX. 22,5 x 26	9" x 10"	15	0,66	96	15,21	1474
CHEVRON 11 x 26	4" x 10"	18	0,514	96	11,6	1130
9 x 36	3,5" x 14"	30	1	72	21,1	1533

PACKING PIEZAS ESPECIALES

FORMATO	PULGADAS	PZ/CAJA	ML	CAJA/PLT	PESO/CAJA	PESO/PLT
DEMI BULLNOSE 1,5 x 30	0,6" x 12"	50	15	120	2,2	276

COLORES · COLOURS

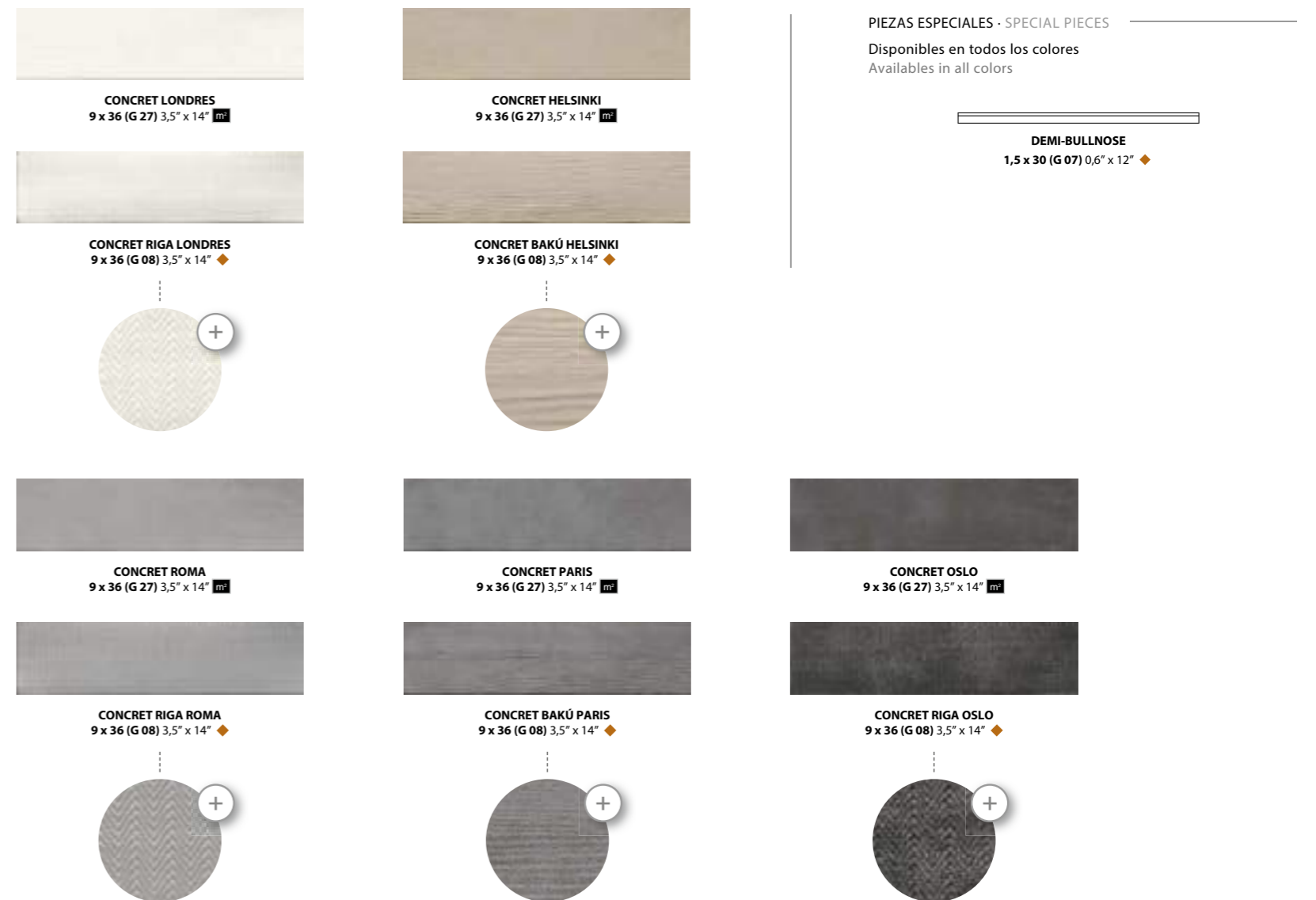

MARE NOSTRUM

Comfort floor
EVOLUTION
EXTRUDED PORCELAIN TILE

RESISTE LA FLEXIÓN
32 N/mn2

RESISTE EL DESGASTE
PEI (I-V)

RESISTE EL RAYADO
MOHS - 4

ANTIDESLIZANTE
Class I

MANCHAS
Class 5 - Class A

ABSORCIÓN
0,2%

DILATACIÓN
5,7* 10⁻⁴ / °C

FORMATOS
7 x 45 - 3" x 17,7"
18 x 18 - 7" x 7"
36 x 36 - 14" x 14"
HEXAGONO 18 x 20,5 - 7" x 8"
ROMBO 11 x 18 - 4,3" x 7"
PROVENZAL 26,5 x 20,5 - 10,3" x 8"

GRES EXTRUSIONADO PORCELÁNICO / PORCELAIN EXTRUDED TILE
SUPERFICIE BRILLO / SURFACE BRIGTNES
PAV. DE INTERIOR / INDOOR FLOOR TILE
REVESTIMIENTO WALL TILE
SIN MANTENIMIENTO / NO MAINTENANCE
RES. A ÁCIDOS Y BASES / RES. TO ACIDS AND BASES
RES. A LA HELADA / FROST PROOF



DECOR



ROMBO MARE NOSTRUM MAHÓN
11 x 18 (G 62) 4,3" x 7" m

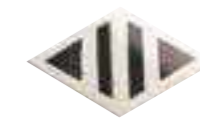

ROMBO MARE NOSTRUM CANNES
11 x 18 (G 62) 4,3" x 7" m

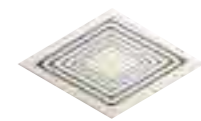

ROMBO MARE NOSTRUM CORFÚ
11 x 18 (G 62) 4,3" x 7" m

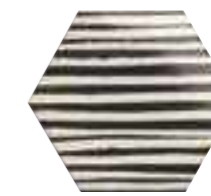

MARE NOSTRUM CANNES HEX.
18 x 20,5 (G 39) 7" x 8" m



MARE NOSTRUM CORFÚ HEX.
18 x 20,5 (G 39) 7" x 8" m

COLORES · COLOURS

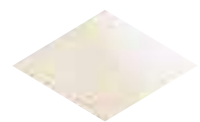

ROMBO MARE NOSTRUM IBIZA
11 x 18 (G 62) 4,3" x 7" m

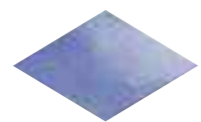

ROMBO MARE NOSTRUM NÁPOLES
11 x 18 (G 62) 4,3" x 7" m

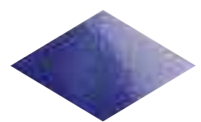

ROMBO MARE NOSTRUM MESSINA
11 x 18 (G 62) 4,3" x 7" m

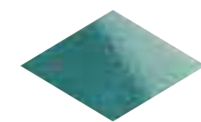

ROMBO MARE NOSTRUM GÉNOVA
11 x 18 (G 62) 4,3" x 7" m

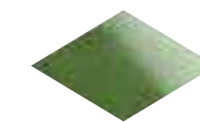

ROMBO MARE NOSTRUM MÓNACO
11 x 18 (G 62) 4,3" x 7" m

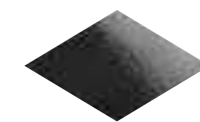

ROMBO MARE NOSTRUM NIZA
11 x 18 (G 62) 4,3" x 7" m



MARE NOSTRUM HEX. IBIZA
18 x 20,5 (G 39) 7" x 8" m

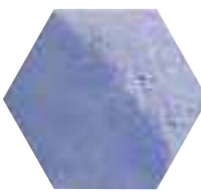

MARE NOSTRUM HEX. NÁPOLES
18 x 20,5 (G 39) 7" x 8" m

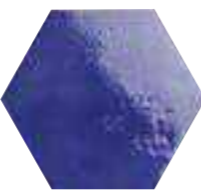

MARE NOSTRUM HEX. MESSINA
18 x 20,5 (G 39) 7" x 8" m

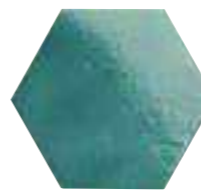

MARE NOSTRUM HEX. GÉNOVA
18 x 20,5 (G 39) 7" x 8" m

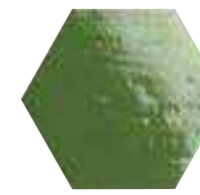

MARE NOSTRUM HEX. MÓNACO
18 x 20,5 (G 39) 7" x 8" m

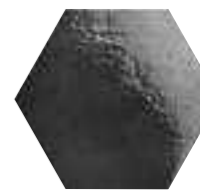

MARE NOSTRUM HEX. NIZA
18 x 20,5 (G 39) 7" x 8" m



MARE NOSTRUM IBIZA
7 x 45 (G 27) 3" x 17,7" m



MARE NOSTRUM NÁPOLES
7 x 45 (G 27) 3" x 17,7" m



MARE NOSTRUM MESSINA
7 x 45 (G 27) 3" x 17,7" m

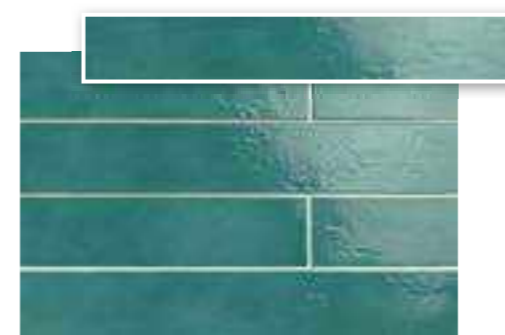

MARE NOSTRUM GÉNOVA
7 x 45 (G 27) 3" x 17,7" m



MARE NOSTRUM MÓNACO
7 x 45 (G 27) 3" x 17,7" m

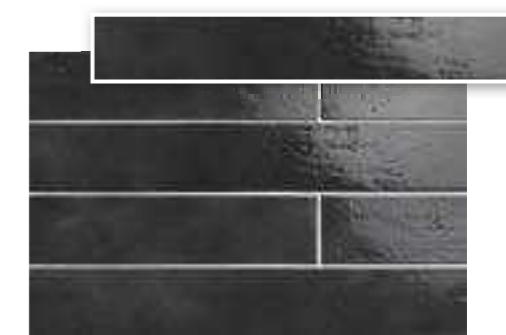

MARE NOSTRUM NIZA
7 x 45 (G 27) 3" x 17,7" m

PACKING BASES

FORMATO	PULGADAS	PZ/CAJA	M²	CAJA/PLT	PESO/CAJA	PESO/PLT
7 x 45	3" x 17,7"	32	1	60	21,4	1.300
HEX. 18 x 20,5	7" x 8"	36	1	48	21	1.024
ROMBO 11 x 18	4,3" x 7"	50	0,495	108	9,4	1.030

MARE NOSTRUM

Comfort floor
EVOLUTION
EXTRUDED PORCELAIN TILE

RESISTE LA FLEXIÓN
32 N/mn2

RESISTE EL DESGASTE
PEI (I - V)

RESISTE EL RAYADO
MOHS - 4

ANTIDESLIZANTE
Class I

MANCHAS
Class 5 - Class A

ABSORCIÓN
0,2%

DILATACIÓN
5,7* 10⁻⁴ / °C

FORMATOS
7 x 45 - 3" x 17,7"
18 x 18 - 7" x 7"
36 x 36 - 14" x 14"
HEXAGONO 18 x 20,5 - 7" x 8"
ROMBO 11 x 18 - 4,3" x 7"
PROVENZAL 26,5 x 20,5 - 10,3" x 8"

GRES EXTRUSIONADO PORCELÁNICO
PORCELAIN EXTRUDED TILE

SUPERFICIE BRILLO
SURFACE BRIGTNNESS

PAV. DE INTERIOR
INDOOR FLOOR TILE

REVESTIMIENTO
WALL TILE

SIN MANTENIMIENTO
NO MAINTENANCE

RES. A ÁCIDOS Y BASES
RES. TO ACIDS AND BASES

RES. A LA HELADA
FROST PROOF



COLORES · COLOURS



MARE NOSTRUM CHIPRE
18 x 18 (G 57) 7" x 7" m



MARE NOSTRUM ATENAS
18 x 18 (G 57) 7" x 7" m



MARE NOSTRUM CRETA
18 x 18 (G 57) 7" x 7" m



MARE NOSTRUM BARCELONA
18 x 18 (G 57) 7" x 7" m



MARE NOSTRUM CHIPRE
36 x 36 (G 57) 14" x 14" m



MARE NOSTRUM ATENAS
36 x 36 (G 57) 14" x 14" m



MARE NOSTRUM CRETA
36 x 36 (G 57) 14" x 14" m



MARE NOSTRUM BARCELONA
36 x 36 (G 57) 14" x 14" m

PROVENZAL · PROVENZAL

COLORES · COLOURS



PROVENZAL IBIZA
26,5 x 20,5 (G 55) 10,3" x 8" m



PROVENZAL MESSINA
26,5 x 20,5 (G 55) 10,3" x 8" m



PROVENZAL GENOVA
26,5 x 20,5 (G 55) 10,3" x 8" m



PROVENZAL NIZA
26,5 x 20,5 (G 55) 10,3" x 8" m



MARE NOSTRUM IBIZA
18 x 18 (G 57) 7" x 7" m



MARE NOSTRUM NÁPOLES
18 x 18 (G 57) 7" x 7" m



MARE NOSTRUM IBIZA
36 x 36 (G 57) 14" x 14" m



MARE NOSTRUM NÁPOLES
36 x 36 (G 57) 14" x 14" m



MARE NOSTRUM MESSINA
18 x 18 (G 57) 7" x 7" m



MARE NOSTRUM GÉNOVA
18 x 18 (G 57) 7" x 7" m



MARE NOSTRUM MÓNACO
18 x 18 (G 57) 7" x 7" m



MARE NOSTRUM NIZA
18 x 18 (G 57) 7" x 7" m



MARE NOSTRUM MESSINA
36 x 36 (G 57) 14" x 14" m



MARE NOSTRUM GÉNOVA
36 x 36 (G 57) 14" x 14" m



MARE NOSTRUM MÓNACO
36 x 36 (G 57) 14" x 14" m



MARE NOSTRUM NIZA
36 x 36 (G 57) 14" x 14" m

PACKING BASES

FORMATO	PULGADAS	PZ/CAJA	M²	CAJA/PLT	PESO/CAJA	PESO/PLT
18 x 18	7" x 7"	30	0,97	72	21,4	1.555
36 x 36	14" x 14"	8	1	48	22,04	1.072
PROVENZAL 26,5 x 20,5	10,3" x 8"	18	0,98	42	19,6	836

PACKING PIEZAS ESPECIALES

FORMATO	PULGADAS	PZ/CAJA	ML	CAJA/PLT	PESO/CAJA	PESO/PLT
DEMI BULLNOSE 1,5 x 30	0,6" x 12"	50	15	120	2,2	276
LISTONE 2,5 x 18	1" x 7"	100	18	60	13,6	-
ROMO 5,5 x 18	2" x 7"	40	7,2	100	12,7	-
ZÓCALO 9 x 36	3,5" x 14"	56	10,8	48	22,5	1.275

PIEZAS ESPECIALES · SPECIAL PIECES

COLORES
IBIZA · CRETA · MESSINA
MÓNACO · BARCELONA · NIZA

LISTONE MARE NOSTRUM
2,5 x 18 (G 10) 1" x 7" ◆

ROMO MARE NOSTRUM
5,5 x 18 (G 11) 2" x 7" ◆

COLORES
IBIZA · CHIPRE

ZÓCALO MARE NOSTRUM
9 x 36 (G 07) 3,5" x 14" ◆

DISPONIBLE EN TODOS LOS COLORES
AVAILABLE IN ALL COLOURS

DEMI-BULLNOSE
1,5 x 30 (G 07) 0,6" x 12" ◆

-  REVESTIMIENTO WALL TILE
-  SUPERFICIE SATINADO GLOSSY SURFACE
-  SIN MANTENIMIENTO NO MAINTENANCE
-  RESISTENTE AL DESGASTE WEAR RESISTANCE
-  RESIST. A LA HELADA FROST PROOF
-  DESTONIFICADO ARMONIOSO CONTROLLED DESTONIFICATION

- FORMATOS
- 25 x 50 - 10" x 20"
 - 5 x 25 - 2" x 10"
 - 21 x 36 - 8" x 14"



TIRA ENMALLADO TRABADA MATSTONE



TIRA ENM. TRABADA MATSTONE MILK
25 x 50 (G 17) 10" x 20"

Compuesta por: TIRA A-10 / B-10 / C-8 / D-10 / E-8



TIRA ENM. TRABADA MATSTONE BEIGE
25 x 50 (G 17) 10" x 20"

Compuesta por: TIRA A-10 / B-10 / C-8 / D-10 / E-8



TIRA ENM. TRABADA MATSTONE ASH
25 x 50 (G 17) 10" x 20"

Compuesta por: TIRA A-10 / B-10 / C-8 / D-10 / E-8



TIRA ENM. TRABADA MATSTONE VALGE
25 x 50 (G 17) 10" x 20"

Compuesta por: TIRA A-8 / B-8 / C-10 / D-8 / E-10



TIRA ENM. TRABADA MATSTONE KULD
25 x 50 (G 17) 10" x 20"

Compuesta por: TIRA A-8 / B-8 / C-10 / D-8 / E-10



TIRA ENM. TRABADA MATSTONE VASK
25 x 50 (G 17) 10" x 20"

Compuesta por: TIRA A-8 / B-8 / C-10 / D-8 / E-10



TIRA ENM. TRABADA MATSTONE MUST
25 x 50 (G 17) 10" x 20"

Compuesta por: TIRA A-8 / B-8 / C-10 / D-8 / E-10

(Compuesta por: TIRA A-10 / B-10 / C-8 / D-10 / E-8)
(Composed by: TIRA A-10 / B-10 / C-8 / D-10 / E-8)

TIRA ENMALLADO MATSTONE

También disponible en MILK, BEIGE y ASH
Available in MILK, BEIGE y Rope ASH



TIRA ENM. MATSTONE VALGE
25 x 50 (G 17) 10" x 20"



TIRA ENM. MATSTONE KULD
25 x 50 (G 17) 10" x 20"



TIRA ENM. MATSTONE VASK
25 x 50 (G 17) 10" x 20"



TIRA ENM. MATSTONE MUST
25 x 50 (G 17) 10" x 20"

TIRA MATSTONE

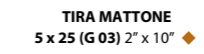
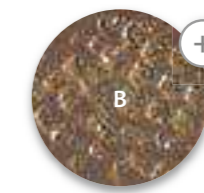
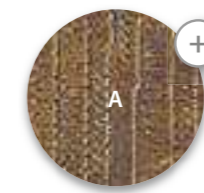

- TIRA MATSTONE**
5 x 25 (G 03) 2" x 10"
- A-8 VALGE KULD VASK MUST
 - A-10 VALGE KULD VASK MUST MILK BEIGE ASH

- B-8 VALGE KULD VASK MUST
- B-10 VALGE KULD VASK MUST MILK BEIGE ASH



- TIRA MATSTONE**
5 x 25 (G 03) 2" x 10"
- C-8 VALGE KULD VASK MUST MILK BEIGE ASH
 - C-10 VALGE KULD VASK MUST

- D-8 VALGE KULD VASK MUST
- D-10 VALGE KULD VASK MUST MILK BEIGE ASH

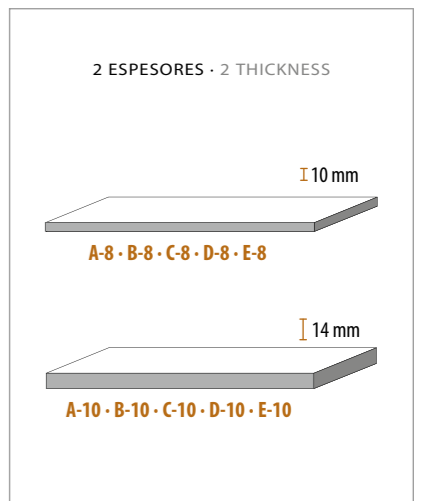

PACKING BASES

FORMATO	PULGADAS	PZ/CAJA	M ²	CAJA/PLT	PESO/CAJA	PESO/PLT
21 x 36	8" x 14"	5	0,38	112	9,1	1.030
25 x 50	10" x 20"	4	0,5	56	12,5	714

PACKING BASES

FORMATO	PULGADAS	PZ/CAJA	M ²	CAJA/PLT	PESO/CAJA	PESO/PLT
5 x 25/8	2" x 10"	18	0,23	196	4,38	873
5 x 25/10	2" x 10"	14	0,18	196	5,56	1.104

MATSTONE

PAVIMENTO

EVOLUTION
EXTRUDED PORCELAIN TILE
Comfort floor
INTERIOR CLASE I
UNE. ENV 12633:2003

PAVIMENTO DE EXTERIOR
OUTDOOR FLOOR TILE
PAVIMENTO DE INTERIOR
INDOOR FLOOR TILE
SUPERFICIE SATINADO
GLOSSY SURFACE

RESISTENTE AL DESGASTE
WEAR RESISTANCE
RESIST. A LA HELADA
FROST PROOF
DESTONIFICADO ARMONIOSO
CONTROLLED DESTONIFICATION

FORMATOS
25 x 50 - 10" x 20"
5 x 25 - 2" x 10"
21 x 36 - 8" x 14"



ENMALLADO MATSTONE



ESPIGA MATSTONE VALGE
21 x 36 (G 30) 8" x 14"



ESPIGA MATSTONE KULD
21 x 36 (G 30) 8" x 14"

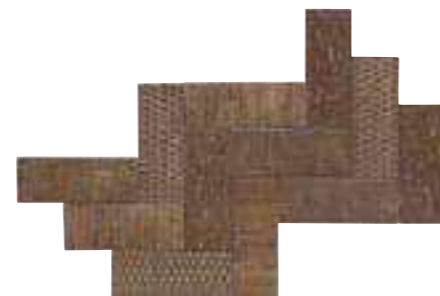

ESPIGA MATSTONE VASK
21 x 36 (G 30) 8" x 14"

ESPIGA MATSTONE

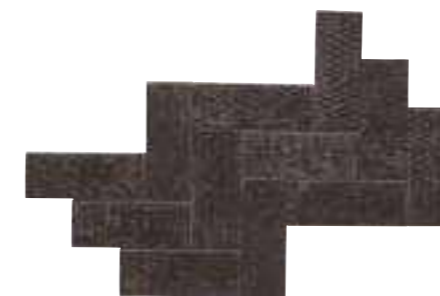

ESPIGA MATSTONE MUST
21 x 36 (G 30) 8" x 14"

También disponible en MILK, BEIGE y ASH
(Compuesta por: TIRA A-10 / B-10 / C-8 / D-10 / E-8)
Availables in MILK, BEIGE y Rope ASH
(Composed by: TIRA A-10 / B-10 / C-8 / D-10 / E-8)

ESPIGA MATSTONE



MATSTONE VALGE
25 x 50 (G 17) 10" x 20"



MATSTONE KULD
25 x 50 (G 17) 10" x 20"



MATSTONE VASK
25 x 50 (G 17) 10" x 20"



MATSTONE MUST
25 x 50 (G 17) 10" x 20"

También disponible en MILK, BEIGE y ASH
(Compuesta por: TIRA A-10 / B-10 / C-8 / D-10 / E-8)
Availables in MILK, BEIGE y Rope ASH
(Composed by: TIRA A-10 / B-10 / C-8 / D-10 / E-8)

PACKING BASES

FORMATO	PULGADAS	PZ/CAJA	M ²	CAJA/PLT	PESO/CAJA	PESO/PLT
PAV. 25 x 50	10" x 20"	5	0,63	78	15	1.201
PAV. 25 x 50 TRAB.	10" x 20"	4	0,5	56	12,5	714

FIGURES

Comfort floor
EVOLUTION
EXTRUDED PORCELAIN TILE

PAV. DE INTERIOR
INDOOR FLOOR TILE

REVESTIMIENTO
WALL TILE

SIN MANTENIMIENTO
NO MAINTENANCE

SUPERFICIE SATINADO
GLOSSY SURFACE

SUPERFICIE BRILLO
SURFACE BRIGTNES

FORMATOS:

15,9 x 18 - 6,3" x 7"
15,5 x 15,5 - 6" x 6"
5 x 25 - 2" x 10"



ÁNGULOS REDONDEADOS · ROUNDED EDGES



FIGURES TRIANGLE BLANC
15,9 x 18 (G 42) 6,3" x 7" m²



FIGURES TRIANGLE ARC
15,9 x 18 (G 42) 6,3" x 7" m²



FIGURES TRIANGLE ESTEL
15,9 x 18 (G 42) 6,3" x 7" m²



FIGURES TRIANGLE BRONZE
15,9 x 18 (G 54) 6,3" x 7" m²



FIGURES TRIANGLE ORO
15,9 x 18 (G 54) 6,3" x 7" m²



FIGURES TRIANGLE PLATA
15,9 x 18 (G 54) 6,3" x 7" m²



FIGURES TRIANGLE ROSAT
15,9 x 18 (G 64) 6,3" x 7" m²



FIGURES TRIANGLE CARMIN
15,9 x 18 (G 64) 6,3" x 7" m²



FIGURES TRIANGLE POMME
15,9 x 18 (G 64) 6,3" x 7" m²



FIGURES TRIANGLE VERT
15,9 x 18 (G 64) 6,3" x 7" m²



FIGURES TRIANGLE BLEU
15,9 x 18 (G 64) 6,3" x 7" m²

DETALLE DETAIL



ÁNGULOS REDONDEADOS
ROUNDED EDGES

ÁNGULOS RECTOS · STRAIGHT EDGES



FIGURES TRIANGLE NATURAL
15,9 x 18 (G 42) 6,3" x 7" m²



FIGURES TRIANGLE DOBLE
15,9 x 18 (G 42) 6,3" x 7" m²



FIGURES RECTANGLE NATURAL
5 x 25 (G 60) 2" x 10" m²



FIGURES QUADRAT NATURAL
15,5 x 15,5 (G 42) 6" x 6" m²



FIGURES QUADRAT DOBLE
15,5 x 15,5 (G 42) 6" x 6" m²



FIGURES QUADRAT ORO
15,5 x 15,5 (G 46) 6" x 6" m²



FIGURES QUADRAT BRONZE
15,5 x 15,5 (G 46) 6" x 6" m²

DETALLE DETAIL



ÁNGULOS RECTOS
STRAIGHT EDGES

DETALLE DETAIL



ÁNGULOS RECTOS
STRAIGHT EDGES

PACKING BASES

FORMATO	PULGADAS	PZ/CAJA	ML	CAJA/PLT	PESO/CAJA	PESO/PLT
15,9 x 18	6,3" x 7"	34	0,485	108	9,76	1070

PACKING BASES

FORMATO	PULGADAS	PZ/CAJA	M²	CAJA/PLT	PESO/CAJA	PESO/PLT
15,9 x 18	6,3" x 7"	34	0,485	108	9,76	1070
DOBLE 15,9 x 18	6,3" x 7"	34	0,485	108	9,76	1070
15,5 x 15,5	6" x 6"	28	0,67	80	13,48	1094
DOBLE 15,5 x 15,5	6" x 6"	28	0,67	80	13,48	1094
5 x 25	2" x 10"	48	0,60	78	12,48	989



FIGURES BISELL FIL



FIGURES BISELL FIL NATURAL
10 x 25 (G 46) 4" x 10" m²



FIGURES BISELL FIL ARGENT
10 x 25 (G 52) 4" x 10" m²



FIGURES BISELL FIL OR
10 x 25 (G 52) 4" x 10" m²

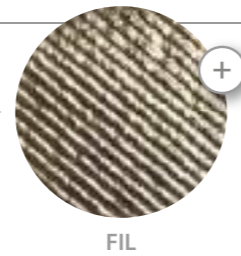

FIL

FIGURES BISELL ONA



FIGURES BISELL ONA NATURAL
10 x 25 (G 46) 4" x 10" m²



FIGURES BISELL ONA ARGENT
10 x 25 (G 52) 4" x 10" m²



FIGURES BISELL ONA OR
10 x 25 (G 52) 4" x 10" m²

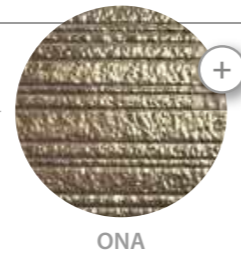

ONA

FIGURES BISELL PLE



FIGURES BISELL PLE NATURAL
10 x 25 (G 46) 4" x 10" m²



FIGURES BISELL PLE ARGENT
10 x 25 (G 52) 4" x 10" m²



FIGURES BISELL PLE OR
10 x 25 (G 52) 4" x 10" m²

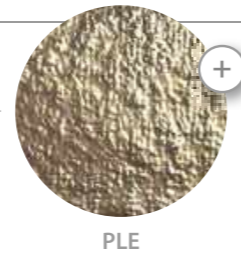

PLE

FIGURES BISELL ZEN



FIGURES BISELL ZEN NATURAL
10 x 25 (G 46) 4" x 10" m²



FIGURES BISELL ZEN ARGENT
10 x 25 (G 52) 4" x 10" m²



FIGURES BISELL ZEN OR
10 x 25 (G 52) 4" x 10" m²



ZEN



FIGURES ESCALE



FIGURES ESCALE BLANC
15 x 25 (G 51) 6" x 10" m²

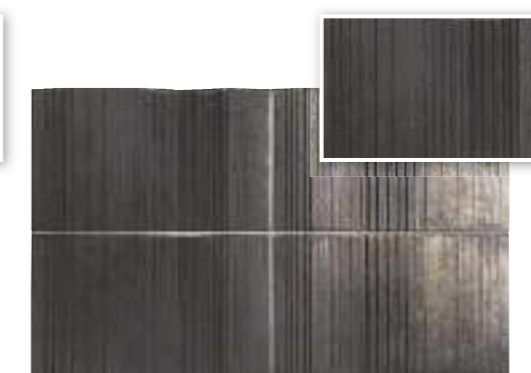

FIGURES ESCALE ARGENT
15 x 25 (G 66) 6" x 10" m²



FIGURES ESCALE OR
15 x 25 (G 66) 6" x 10" m²

PACKING BASES

FORMATO	PULGADAS	PZ/CAJA	M²	CAJA/PLT	PESO/CAJA	PESO/PLT
10 x 25	4" x 10"	20	0,50	-	12,9	-

PACKING BASES

FORMATO	PULGADAS	PZ/CAJA	M²	CAJA/PLT	PESO/CAJA	PESO/PLT
15 x 25	6" x 10"	10	0,375	60	7,8	485

PATRONS [FIGURES]

EVOLUTION
EXTRUDED PORCELAIN TILE

PE GRES EXTR. PORCELÁNICO
PORCELAIN EXTRUDED TILE

REVESTIMIENTO
WALL TILE

SUPERFICIE MATE
MATT SURFACE

RESIST. A LA HELADA
FROST PROOF

RESIST. A ÁCIDOS Y BASES
RESIST. TO ACIDS & BASES

FORMATO:
15,5 x 15,5 - 6" x 6"

VELVET [FIGURES]

EVOLUTION
EXTRUDED PORCELAIN TILE

PE GRES EXTR. PORCELÁNICO
PORCELAIN EXTRUDED TILE

REVESTIMIENTO
WALL TILE

RESIST. A LA HELADA
FROST PROOF

RESIST. A ÁCIDOS Y BASES
RESIST. TO ACIDS & BASES

SUPERFICIE MATE
MATT SURFACE



FIGURES PATRONS

FIGURES VELVET



FIGURES PATRONS FLETXA BIANCO
15,5 x 15,5 (G 46) 6" x 6" m²



FIGURES PATRONS PLEC BIANCO
15,5 x 15,5 (G 46) 6" x 6" m²



FIGURES PATRONS FLETXA NOTTE
15,5 x 15,5 (G 46) 6" x 6" m²



FIGURES PATRONS PLEC NOTTE
15,5 x 15,5 (G 46) 6" x 6" m²



FIGURES VELVET
MULTIFORMATO (G 65) m²

COMPOSICIÓN 1,1 M2

Consultar disponibilidad
Check availability

PACKING BASES

FORMATO	PULGADAS	PZ/CAJA	M²	CAJA/PLT	PESO/CAJA	PESO/PLT
FLETXA 15,5x15,5	6" x 6"	20	0,48	80	13,06	1.067,80
PLEC 15,5x15,5	6" x 6"	22	0,53	80	13,31	1.087,80

SQUAMA

EVOLUTION
EXTRUDED PORCELAIN TILE
Pasta Blanca

-  REVESTIMIENTO WALL TILE
-  SUPERFICIE BRILLO SURFACE BRIGHTNESS
-  SIN MANTENIMIENTO NO MAINTENANCE

FORMATOS:
ESCAMA 12,7 x 6,2 - 5" x 2,5"



EVOLUTION
EXTRUDED PORCELAIN TILE

Pasta Blanca



SQUAMA PORC. LUZ
12,7 x 6,2 (G 51) 5" x 2,5" 



SQUAMA PORC. IRON
12,7 x 6,2 (G 51) 5" x 2,5" 



SQUAMA PORC. CLOUD
12,7 x 6,2 (G 51) 5" x 2,5" 



SQUAMA RICE
12,7 x 6,2 (G 63) 5" x 2,5" 



SQUAMA MIST
12,7 x 6,2 (G 63) 5" x 2,5" 



SQUAMA PORC. OCEAN
12,7 x 6,2 (G 51) 5" x 2,5" 



SQUAMA PORC. INDIGO
12,7 x 6,2 (G 51) 5" x 2,5" 

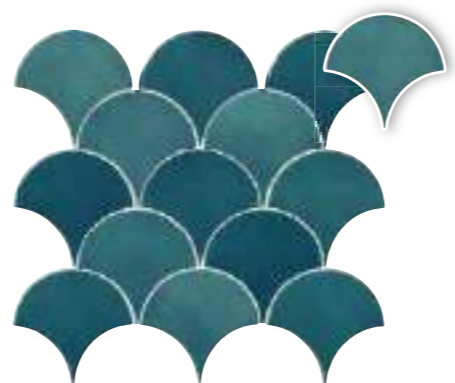

SQUAMA PORC. EMERALD
12,7 x 6,2 (G 51) 5" x 2,5" 



SQUAMA MAYA
12,7 x 6,2 (G 63) 5" x 2,5" 



SQUAMA TURCHESE
12,7 x 6,2 (G 63) 5" x 2,5" 

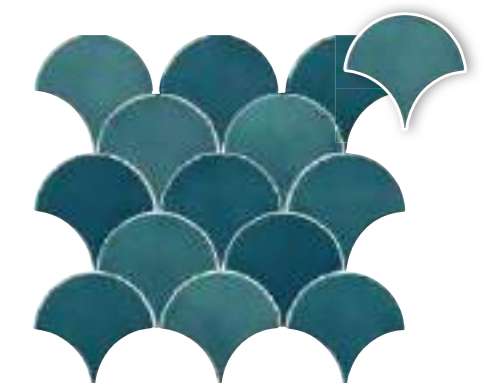

SQUAMA OLIVE
12,7 x 6,2 (G 63) 5" x 2,5" 

PACKING BASES PORCELÁNICO

FORMATO	PULGADAS	PZ/CAJA	M ²	CAJA/PLT	PESO/CAJA	PESO/PLT
ESCAMA 12,7 x 6,2	5" x 2,5"	45	0,35	78	8,7	689

PACKING BASES PASTA BLANCA

FORMATO	PULGADAS	PZ/CAJA	M ²	CAJA/PLT	PESO/CAJA	PESO/PLT
ESCAMA 12,7 x 6,2	5" x 2,5"	48	0,38	78	6,45	532

PACKING PIEZAS ESPECIALES

FORMATO	PULGADAS	PZ/CAJA	ML	CAJA/PLT	PESO/CAJA	PESO/PLT
DEMI BULLNOSE 1,5 x 30	0,6" x 12"	50	15	120	2,2	276

PIEZAS ESPECIALES · SPECIAL PIECES

Disponibles en todos los colores
Availables in all colors

DEMI-BULLNOSE
1,5 x 30 (G 07) 0,6" x 11,8" 

Riad

EVOLUTION
EXTRUDED PORCELAIN TILE
EFFECT
MICRO CRAQUELÉ

REVESTIMIENTO
WALL TILE
SIN MANTENIMIENTO
NO MAINTENANCE
SUPERFICIE BRILLO
SURFACE BRIGTNES

FORMATOS:
7,2 x 22,2 - 3" x 8,5"
ESCAMA 12,7 x 6,2 - 5" x 2,5"
LÁGRIMA 11 x 8 - 4" x 3"
LÁGRIMA ENM. 40 x 43,5 - 16" x 17,4"



BASE LISA · SMOOTH BASE

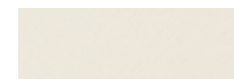

RIAD COTTO
7,2 x 22,2 (G 62) 3" x 8,5" m²



RIAD MARFIL
7,2 x 22,2 (G 62) 3" x 8,5" m²

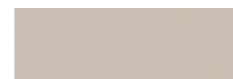

RIAD GRIS
7,2 x 22,2 (G 62) 3" x 8,5" m²

ESCAMA · SCALE



RIAD ESCAMA COTTO
12,7 x 6,2 (G 54) 5" x 2,5" m²
RIAD ESCAMA RAMPA COTTO
12,7 x 6,2 (G 50) 5" x 2,5" m²



RIAD ESCAMA MARFIL
12,7 x 6,2 (G 54) 5" x 2,5" m²



RIAD ESCAMA GRIS
12,7 x 6,2 (G 54) 5" x 2,5" m²

PIEZAS ESPECIALES · SPECIAL PIECES

Disponibles en todos los colores · Available in all colors

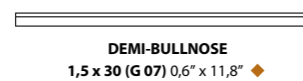

PACKING BASES

FORMATO	PULGADAS	PZ/CAJA	M ²	CAJA/PLT	PESO/CAJA	PESO/PLT
7,2 x 22,2	3" x 8,5"	50	0,843	60	16,55	1.007
LÁGRIMA 11 x 8	4" x 3"	45	0,4	120	8,10	990
LÁGRIMA ENM. 40 x 43,5	16" x 17,4"	7	1,204	56	25	1.415
ESCAMA 12,7 x 6,2	5" x 2,5"	51	0,401	78	10	780
ESCAMA RAMPA 12,7 x 6,2	5" x 2,5"	48	0,38	78	9,41	748

PACKING PIEZAS ESPECIALES

FORMATO	PULGADAS	PZ/CAJA	ML	CAJA/PLT	PESO/CAJA	PESO/PLT
DEMI BULLNOSE 1,5 x 30	0,6" x 12"	50	15	120	2,2	276

LÁGRIMA · TEAR



RIAD COTTO
LÁGRIMA 11 x 8 (G 50) 4" x 3" m²
LÁGR. ENM. 40 x 43,5 (G 61) 16" x 17,4" m² ☒



RIAD MARFIL
LÁGRIMA 11 x 8 (G 50) 4" x 3" m²
LÁGR. ENM. 40 x 43,5 (G 61) 16" x 17,4" m² ☒



RIAD GRIS
LÁGRIMA 11 x 8 (G 50) 4" x 3" m²
LÁGR. ENM. 40 x 43,5 (G 61) 16" x 17,4" m² ☒



RIAD CENDRA
LÁGRIMA 11 x 8 (G 50) 4" x 3" m²
LÁGR. ENM. 40 x 43,5 (G 61) 16" x 17,4" m² ☒



RIAD VERD
LÁGRIMA 11 x 8 (G 50) 4" x 3" m²
LÁGR. ENM. 40 x 43,5 (G 61) 16" x 17,4" m² ☒



RIAD BLAU
LÁGRIMA 11 x 8 (G 50) 4" x 3" m²
LÁGR. ENM. 40 x 43,5 (G 61) 16" x 17,4" m² ☒

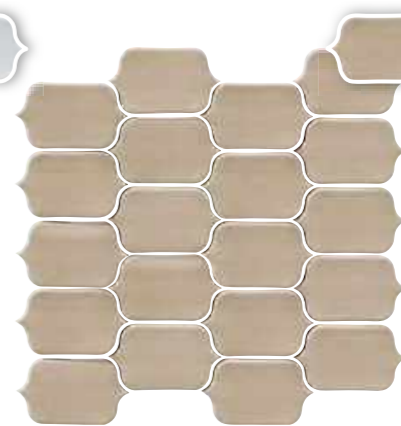

RIAD BEIGE
LÁGRIMA 11 x 8 (G 50) 4" x 3" m²
LÁGR. ENM. 40 x 43,5 (G 61) 16" x 17,4" m² ☒



ESCAMA RAMPA - RAMP SCALE



LISO



ART ESCAMA RAMPA MOON
12,7 x 6,2 (G 61) 5" x 2,5" m



BOSCO



ART ESCAMA RAMPA BOSCO MOON
12,7 x 6,2 (G 61) 5" x 2,5" m



GOYA



ART ESCAMA RAMPA GOYA MOON
12,7 x 6,2 (G 61) 5" x 2,5" m



GRECO

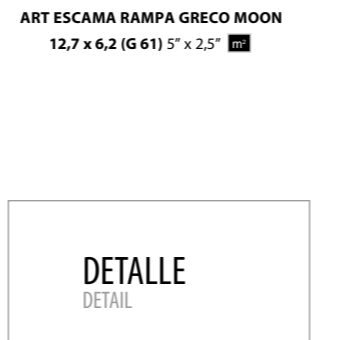

ART ESCAMA RAMPA GRECO MOON
12,7 x 6,2 (G 61) 5" x 2,5" m



ART ESCAMA RAMPA ROPE 10
12,7 x 6,2 (G 61) 5" x 2,5" m



ART ESCAMA RAMPA BOSCO ROPE 10
12,7 x 6,2 (G 61) 5" x 2,5" m



ART ESCAMA RAMPA ALUMINIUM 10
12,7 x 6,2 (G 61) 5" x 2,5" m



ART ESCAMA RAMPA GOYA ALUMINIUM 10
12,7 x 6,2 (G 61) 5" x 2,5" m

DETALLE
DETAIL



ESCAMA RAMPA
12,7 x 6,2 - 5" x 2,5"



PACKING BASES

FORMATO	PULGADAS	PZ/CAJA	M²	CAJA/PLT	PESO/CAJA	PESO/PLT
ESCAMA RAMPA 12,7 x 6,2	5" x 2,5"	48	0,38	78	9,41	748

Art

EVOLUTION
EXTRUDED PORCELAIN TILE

REVESTIMIENTO
WALL TILE

RESISTENCIA AL RAYADO
SCRATCH RESISTANCE

RESIST. A LA HELADA
FROST PROOF

SUPERFICIE SATINADO
GLOSSY SURFACE

RESIST. A ÁCIDOS Y BASES
RESIST. TO ACIDS & BASES











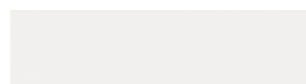

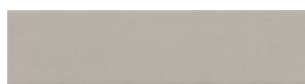

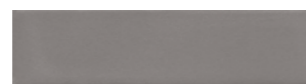
SIN MANTENIMIENTO
NO MAINTENANCE

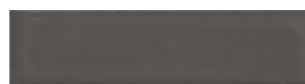





FORMATOS:

7,5 x 30 - 3" x 12"
HEX. 13 x 11,4 - 5" x 4"
HEX. RAMPA 13 x 11,4 - 5" x 4"
ESPIGA 16,3 x 31,5 - 6,4" x 12,3"



BASE LISA · SMOOTH BASE

 ART MOON 7,5 x 30 (G 59) 3" x 12" 	 ART ALUMINIUM 10 7,5 x 30 (G 59) 3" x 12" 	 ART ALUMINIUM 20 7,5 x 30 (G 59) 3" x 12" 	 ART ALUMINIUM 30 7,5 x 30 (G 59) 3" x 12" 
	 ART ROPE 10 7,5 x 30 (G 59) 3" x 12" 	 ART ROPE 20 7,5 x 30 (G 59) 3" x 12" 	 ART ROPE 30 7,5 x 30 (G 59) 3" x 12" 

 ART MIRÓ ALUMINIUM 10 ART MIRÓ ROPE 10 ART MIRÓ MOON 7,5 x 30 (G 64) 3" x 12" 	 ART MONET ALUMINIUM 10 ART MONET ROPE 10 ART MONET MOON 7,5 x 30 (G 64) 3" x 12" 	 ART KLIMT ALUMINIUM 10 ART KLIMT ROPE 10 ART KLIMT MOON 7,5 x 30 (G 64) 3" x 12" 
--	---	---

Disponible en Moon, Aluminium 10 y Rope 10
Availables in Moon, Aluminium 10 y Rope 10

HEXÁGONO · HEXAGON

 ART HEX. MIRÓ ALUMINIUM 10 ART HEX. MIRÓ ROPE 10 ART HEX. MIRÓ MOON 13 x 11,4 (G 50) 5" x 4" 	 ART HEX. MONET ALUMINIUM 10 ART HEX. MONET ROPE 10 ART HEX. MONET MOON 13 x 11,4 (G 50) 5" x 4" 
--	--

Disponible en Moon, Aluminium 10 y Rope 10
Availables in Moon, Aluminium 10 y Rope 10











PACKING BASES



FORMATO	PULGADAS	PZ/CAJA	M²	CAJA/PLT	PESO/CAJA	PESO/PLT
7,5 x 30	3" x 12"	21	0,47	120	8,11	990
HEX. 13 x 11,4	5" x 4"	44	0,48	96	9,12	890
HEX. RAMPA 13 x 11,4	5" x 4"	37	0,40	96	8,7	858
ESPIGA 16,3 x 31,5	6,4" x 12,3"	14	0,7	72	15,6	1.144

HEX. RAMPA · RAMP HEX.





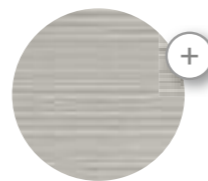

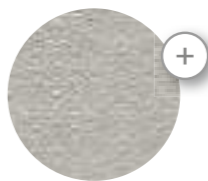
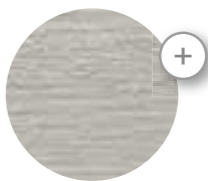
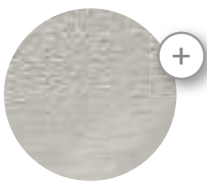



Disponible en Moon, Aluminium 10 y Rope 10
Availables in Moon, Aluminium 10 y Rope 10

 ART HEX. RAMPA MIRÓ ALUMINIUM 10 ART HEX. RAMPA MIRÓ ROPE 10 ART HEX. RAMPA MIRÓ MOON 13 x 11,4 (G 52) 5" x 4" 	 ART HEX. RAMPA MONET ALUMINIUM 10 ART HEX. RAMPA MONET ROPE 10 ART HEX. RAMPA MONET MOON 13 x 11,4 (G 52) 5" x 4" 	 ART HEX. RAMPA KLIMT ALUMINIUM 10 ART HEX. RAMPA KLIMT ROPE 10 ART HEX. RAMPA KLIMT MOON 13 x 11,4 (G 52) 5" x 4" 	 ART HEX. RAMPA DALÍ ALUMINIUM 10 ART HEX. RAMPA DALÍ ROPE 10 ART HEX. RAMPA DALÍ MOON 13 x 11,4 (G 52) 5" x 4" 	 ART HEX. RAMPA PICASSO ALUMINIUM 10 ART HEX. RAMPA PICASSO ROPE 10 ART HEX. RAMPA PICASSO MOON 13 x 11,4 (G 52) 5" x 4" 
--	---	---	--	---

 MIRÓ	 MONET	 KLIMT	 DALÍ	 PICASSO
--	---	---	--	---

ESPIGA · SPIKE

Disponible en Moon, Aluminium 10 y Rope 10
Availables in Moon, Aluminium 10 y Rope 10

 ART ESPIGA PICASSO ALUMINIUM 10 (izq.) ART ESPIGA PICASSO ROPE 10 (izq.) ART ESPIGA PICASSO MOON (izq.) 16,3 x 31,5 (G 52) 6,4" x 12,3" 	 ART ESPIGA PICASSO ALUMINIUM 10 (dcha.) ART ESPIGA PICASSO ROPE 10 (dcha.) ART ESPIGA PICASSO MOON (dcha.) 16,3 x 31,5 (G 52) 6,4" x 12,3" 	 ART ESPIGA KLIMT ALUMINIUM 10 (izq.) ART ESPIGA KLIMT ROPE 10 (izq.) ART ESPIGA KLIMT MOON (izq.) 16,3 x 31,5 (G 52) 6,4" x 12,3" 	 ART ESPIGA KLIMT ALUMINIUM 10 (dcha.) ART ESPIGA KLIMT ROPE 10 (dcha.) ART ESPIGA KLIMT MOON (dcha.) 16,3 x 31,5 (G 52) 6,4" x 12,3" 
--	---	--	---

CAPRICE

EVOLUTION
EXTRUDED PORCELAIN TILE

 **VOLUMEN**
VOLUME

 **SUPERFICIE SATINADA**
GLOSSY SURFACE

FORMATOS:
ENM. HEX. 45,5 x 20 - 17,7" x 8"
HEX. 13 x 11,4 - 5" x 4"
ESCAMA 12,7 x 6,2 - 5" x 2,5"



CON RELIEVE - EMBOSSED



CENTRO HEXÁGONO CAPRICE BIANCO
45,5 x 20 (G 31) 17,7" x 8" 



CENTRO HEXÁGONO CAPRICE NOTTE
45,5 x 20 (G 31) 17,7" x 8" 

SIN RELIEVE - SMOOTH



CAPRICE HEX. ENM. BIANCO SMOOTH
45,5 x 20 (G 31) 17,7" x 8" 

Varios DISEÑOS
Se suministran mezclados
Several DESIGNS
Supplied mixed



CAPRICE BIANCO SMOOTH
13 x 11,4 (G 50) 5" x 4" 



CAPRICE HEX. ENM. NOTTE SMOOTH
45,5 x 20 (G 31) 17,7" x 8" 

Varios DISEÑOS
Se suministran mezclados
Several DESIGNS
Supplied mixed



CAPRICE NOTTE SMOOTH
13 x 11,4 (G 50) 5" x 4" 

ESCAMA - SCALE



3 DISEÑOS DIFERENTES - Se suministran mezclados
3 DIFFERENTS DESIGNS - Supplied mixed

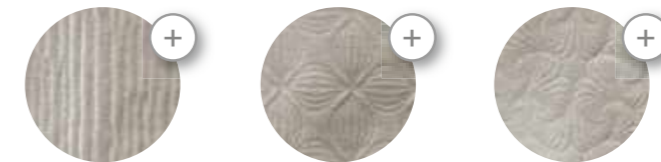

PACKING BASES

FORMATO	PULGADAS	PZ/CAJA	M²	CAJA/PLT	PESO/CAJA	PESO/PLT
HEX. 13 x 11,4	5" x 4"	36	0,4	98	9,14	909
HEX. 13 x 11,4 GRUESO	5" x 4"	26	0,29	98	9,2	916
ENM. HEX. 45,5 x 20	17,5" x 8"	5	0,455	112	10,1	1.145
ESCAMA 12,7 x 6,2	5" x 2,5"	51	0,401	78	10	780

CAPRICE

EVOLUTION
EXTRUDED PORCELAIN TILE

- VOLUMEN
VOLUME
- SUPERFICIE SATINADO
GLOSSY SURFACE

FORMATOS:

- OCTG. 7 17 x 17 - 6,6" x 6,6"
- TACO 7 x 7 - 2,7" x 2,7"
- OCTG. 5 12,2 x 12,2 - 4,8" x 4,8"
- TACO 5 x 5 - 2" x 2"
- OCTG. 4 16,7 x 16,7 - 6,5" x 6,5"
- TACO 4,8 x 4,8 - 2" x 2"

MARE SUL TEMPO

Comfort floor
EVOLUTION
EXTRUDED PORCELAIN TILE

- RESISTE LA FLEXIÓN
32 N/mm²
- RESISTE EL DESGASTE
PEI (I-V)
- RESISTE EL RAYADO
MOHS - 4
- ANTIDESLIZANTE
Class I
- MANCHAS
Class 5 - Class A
- ABSORCIÓN
<0,2%
- DILATACIÓN
5,7* 10⁻⁴/°C

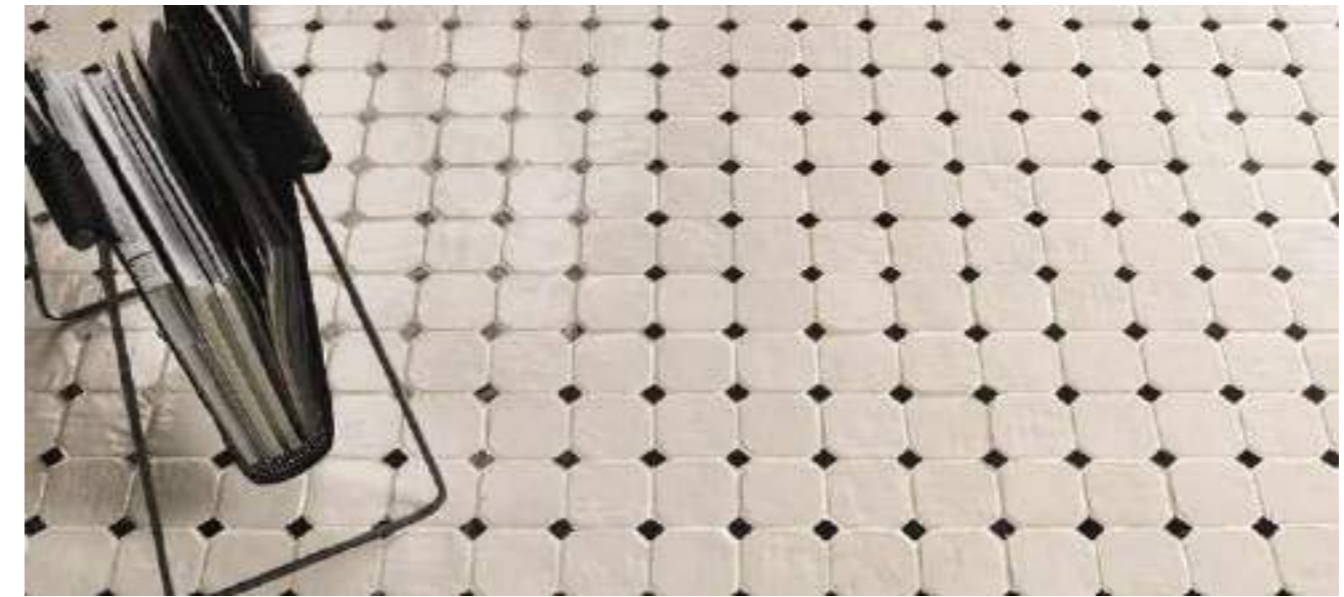

FORMATO:

OCTG. 31,6 x 31,6 - 12,4" x 12,4"

- GRES EXTR. PORCELÁNICO
PORCELAIN EXTRUDED TILE
- RESIST. A ÁCIDOS Y BASES
RESIST. TO ACIDS & BASES
- SIN MANTENIMIENTO
NO MAINTENANCE
- RESIST. A LA HELADA
FROST PROOF
- ENVEJECIDO
OLD LOOKING
- PAV. DE INTERIOR
INDOOR FLOOR TILE
- SUPERFICIE BRILLO
SURFACE BRIGHTNESS

BASE - BASE

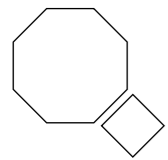

OCTG. 7 17 x 17 (G 06) 6,6" x 6,6"
TACO 7 x 7 (G 01) 2,7" x 2,7"

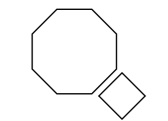

OCTG. 5 12,2 x 12,2 (G 03) 4,8" x 4,8"
TACO 5 x 5 (G 01) 2" x 2"

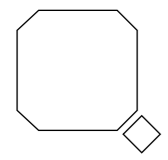

OCTG. 4 16,7 x 16,7 (G 06) 6,5" x 6,5"
TACO 4,8 x 4,8 (G 01) 2" x 2"

ENMALLADOS - ON A MESH



ENMALLADO OCTG. BIANCO -7 (17x17)
35 x 35 (G 50) 13,7" x 13,7" m²



ENMALLADO OCTG. BIANCO -5 (12,2x12,2)
37 x 37 (G 52) 14,5" x 14,5" m²



ENMALLADO OCTG. BIANCO -4 (16,7x16,7)
34 x 34 (G 51) 13,3" x 13,3" m²

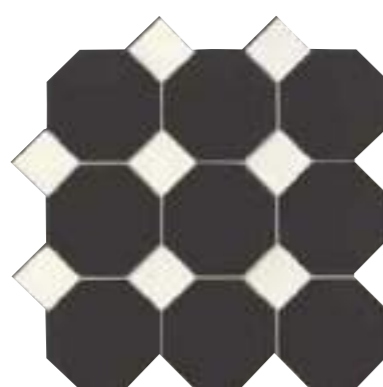

ENMALLADO OCTG. NOTTE -7 (17x17)
35 x 35 (G 50) 13,7" x 13,7" m²

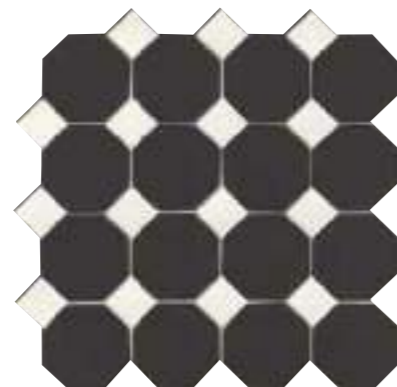

ENMALLADO OCTG. NOTTE -5 (12,2x12,2)
37 x 37 (G 52) 14,5" x 14,5" m²



ENMALLADO OCTG. NOTTE -4 (16,7x16,7)
34 x 34 (G 51) 13,3" x 13,3" m²

ENMALLADOS - ON A MESH

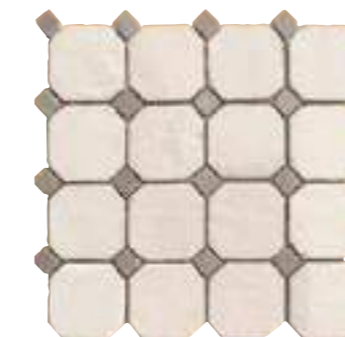

MARE SUL TEMPO ATENAS
31,6 x 31,6 (G 66) 12,4" x 12,4" m²

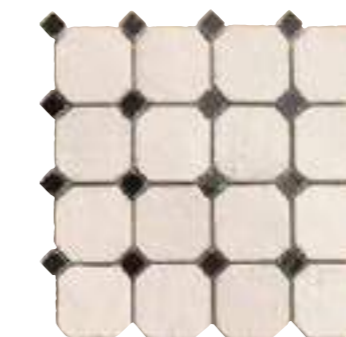

MARE SUL TEMPO NIZA
31,6 x 31,6 (G 66) 12,4" x 12,4" m²

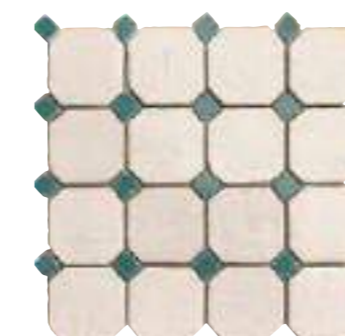

MARE SUL TEMPO GÉNOVA
31,6 x 31,6 (G 66) 12,4" x 12,4" m²

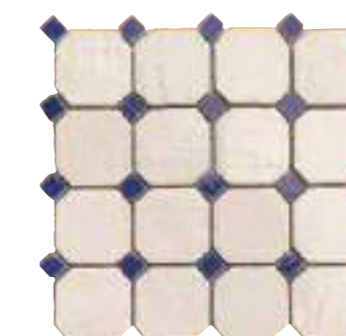

MARE SUL TEMPO MESSINA
31,6 x 31,6 (G 66) 12,4" x 12,4" m²

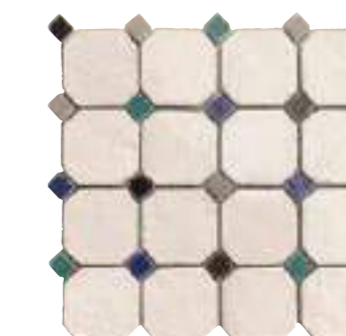

MARE SUL TEMPO MIX
31,6 x 31,6 (G 66) 12,4" x 12,4" m²

MARE SUL TEMPO combina con las bases de la serie MARE NOSTRUM en pág: 42-43
MARE SUL TEMPO combines with MARE NOSTRUM , pág. 42-43

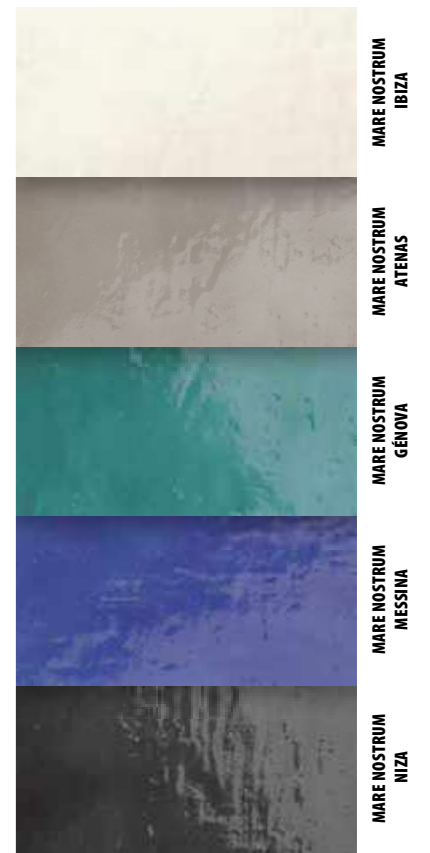

PACKING BASES

FORMATO	PULGADAS	PZ/CAJA	M ²	CAJA/PLT	PESO/CAJA	PESO/PLT
17 x 17	6,6" x 6,6"	31	0,74	72	17,15	1.250
12,2 x 12,2	4,8" x 4,8"	42	0,525	60	12,90	790
16,7 x 16,7	6,5" x 6,5"	31	0,727	72	16,90	1.235
ENM. OCT. 7 35 x 35	13,7" x 13,7"	7	0,86	56	15,35	878
ENM. OCT. 5 37 x 37	14,5" x 14,5"	7	0,96	56	21,7	1.235
ENM. IRREG. 34 x 34	13,3" x 13,3"	7	0,81	56	16,05	913

PACKING PIEZAS ESPECIALES

FORMATO	PULGADAS	PZ/CAJA	ML	CAJA/PLT	PESO/CAJA
TACO 7 x 7	2,7" x 2,7"	58	4,06	60	2,38
TACO 5 x 5	2" x 2"	90	4,5	60	2,10
TACO 4,8 x 4,8	2" x 2"	90	4,32	60	1,85

COMPOSICION POR M ² :	Caprice Octg. -7	17 x 17	35 Pz.	+	Taco Caprice	7 x 7	35 Pz.
Caprice Octg. -5	12,2 x 12,2	68 Pz.	+	Taco Caprice	5 x 5	68 Pz.	
Caprice Octg. -4	16,7 x 16,7	36 Pz.	+	Taco Caprice	4,8 x 4,8	36 Pz.	

PACKING BASES

FORMATO	PULGADAS	PZ/CAJA	M ²	CAJA/PLT	PESO/CAJA	PESO/PLT
31,6 x 31,6	12,4" x 12,4"	10	1	36	21	764

NEW PANAL



- PAV. DE INTERIOR
INDOOR FLOOR TILE
- REVESTIMIENTO
WALL TILE
- SIN MANTENIMIENTO
NO MAINTENANCE

- RESISTENCIA AL RAYADO
SCRATCH RESISTANCE
- RESIST. A LA HELADA
FROST PROOF
- RESISTENTE AL DESGASTE
WEAR RESISTANCE

FORMATOS:
 CHEVRON IZQ./DCHA. 17,2 x 7,3 - 7" x 3"
 ROMBO 15 x 8,5 - 6" x 3,3"
 HEX. 15 x 17 - 6" x 7"
 HEX. 6,5 x 7,5 - 2,5" x 3"
 HEX. 6,5 x 22,5 - 2,5" x 8,8"
 ENM. HEX. 38 x 39,5 - 15" x 15,5"



HEXÁGONO (14) - HEXAGON (14)



HEX. (14) NEW PANAL FARINA 15 x 17 (G 64) 6" x 7"
 HEX. (14) NEW PANAL BEIGE 15 x 17 (G 64) 6" x 7"
 HEX. (14) NEW PANAL ASH 15 x 17 (G 64) 6" x 7"



DECORACIÓN (14) - DECORATION (14)

EVOLUTION EXTRUDED PORCELAIN TILE 3 DISEÑOS DIFERENTES - SE SUMINISTRAN MEZCLADOS



DECOR TEMPO HEX. (14) 15 x 17 (G 64) 6" x 7"
 DECOR MOOD HEX. (14) 15 x 17 (G 64) 6" x 7"

HEXÁGONO (10) - HEXAGON (10)



HEX. (10) NEW PANAL FARINA 15 x 17 (G 63) 6" x 7"
 HEX. (10) NEW PANAL CREAM 15 x 17 (G 63) 6" x 7"
 HEX. (10) NEW PANAL STORM 15 x 17 (G 63) 6" x 7"
 HEX. (10) NEW PANAL CARBO 15 x 17 (G 63) 6" x 7"
 HEX. (10) NEW PANAL DÍA 15 x 17 (G 61) 2,5" x 3"
 6,5 x 7,5 (G 61) 2,5" x 3"
 6,5 x 22,5 (G 61) 2,5" x 8,8"
 ENM. 38 x 39,5 (G 36) 15" x 15,5"



CHEVRON (14) - CHEVRON (14)



CHEVRON IZQ. / DCHA. (14) NEW PANAL FARINA 17,2 x 7,3 (G 64) 7" x 3"
 CHEVRON IZQ. / DCHA. (14) NEW PANAL FARINA DECOR 17,2 x 7,3 (G 64) 7" x 3"
 CHEVRON IZQ. / DCHA. (14) NEW PANAL BEIGE 17,2 x 7,3 (G 64) 7" x 3"
 CHEVRON IZQ. / DCHA. (14) NEW PANAL ASH 17,2 x 7,3 (G 64) 7" x 3"



CHEVRON (10) - CHEVRON (10)

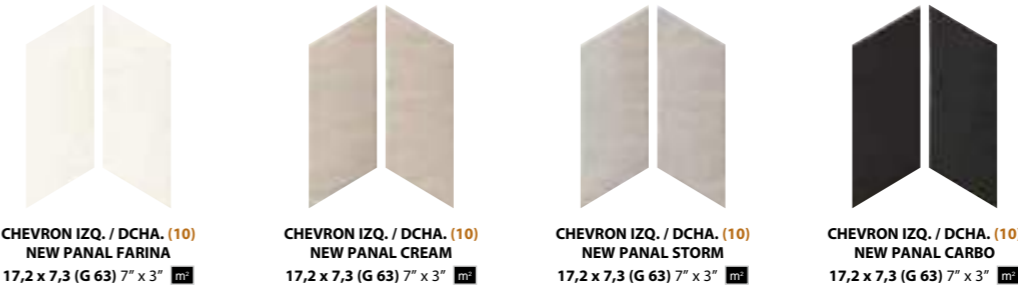

CHEVRON IZQ. / DCHA. (10) NEW PANAL FARINA 17,2 x 7,3 (G 63) 7" x 3"
 CHEVRON IZQ. / DCHA. (10) NEW PANAL CREAM 17,2 x 7,3 (G 63) 7" x 3"
 CHEVRON IZQ. / DCHA. (10) NEW PANAL STORM 17,2 x 7,3 (G 63) 7" x 3"
 CHEVRON IZQ. / DCHA. (10) NEW PANAL CARBO 17,2 x 7,3 (G 63) 7" x 3"



ROMBO (14) - RHOMBUS (14)



ROMBO (14) NEW PANAL FARINA 15 x 8,5 (G 54) 6" x 3,3"
 ROMBO (14) NEW PANAL BEIGE 15 x 8,5 (G 54) 6" x 3,3"
 ROMBO (14) NEW PANAL ASH 15 x 8,5 (G 54) 6" x 3,3"



ROMBO TREND (10) - RHOMBUS TREND (10)



ROMBO TREND (10) NEW PANAL WHITE 15 x 8,5 (G 50) 6" x 3,3"
 ROMBO TREND (10) NEW PANAL CREAM 15 x 8,5 (G 50) 6" x 3,3"
 ROMBO TREND (10) NEW PANAL STORM 15 x 8,5 (G 50) 6" x 3,3"



ROMBO (10) - RHOMBUS (10)

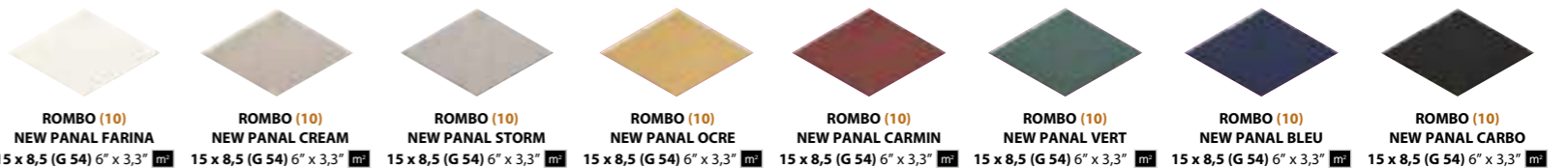

ROMBO (10) NEW PANAL FARINA 15 x 8,5 (G 54) 6" x 3,3"
 ROMBO (10) NEW PANAL CREAM 15 x 8,5 (G 54) 6" x 3,3"
 ROMBO (10) NEW PANAL STORM 15 x 8,5 (G 54) 6" x 3,3"
 ROMBO (10) NEW PANAL OCRE 15 x 8,5 (G 54) 6" x 3,3"
 ROMBO (10) NEW PANAL CARMIN 15 x 8,5 (G 54) 6" x 3,3"
 ROMBO (10) NEW PANAL VERT 15 x 8,5 (G 54) 6" x 3,3"
 ROMBO (10) NEW PANAL BLEU 15 x 8,5 (G 54) 6" x 3,3"
 ROMBO (10) NEW PANAL CARBO 15 x 8,5 (G 54) 6" x 3,3"

ROMBO TOP (10) - RHOMBUS TOP (10)



ROMBO TOP (10) NEW PANAL TITANI 15 x 8,5 (G 07) 6" x 3,3"
 ROMBO TOP (10) NEW PANAL TABAC 15 x 8,5 (G 07) 6" x 3,3"
 ROMBO TOP (10) NEW PANAL CAQUI 15 x 8,5 (G 07) 6" x 3,3"
 ROMBO TOP (10) NEW PANAL VERMELL 15 x 8,5 (G 07) 6" x 3,3"
 ROMBO TOP (10) NEW PANAL MENTA 15 x 8,5 (G 07) 6" x 3,3"
 ROMBO TOP (10) NEW PANAL TURQUESA 15 x 8,5 (G 07) 6" x 3,3"
 ROMBO TOP (10) NEW PANAL COBALTO 15 x 8,5 (G 07) 6" x 3,3"

PACKING BASES

FORMATO	PULGADAS	PZ/CAJA	M²	CAJA/PLT	PESO/CAJA	PESO/PLT
HEX.15 x 17 (10)	6" x 7"	26	0,5	80	12,45	1.010
HEX.15 x 17 (14)	6" x 7"	19	0,37	80	10,57	861
HEX. 6,5 x 22,5	2,5" x 8,8"	40	0,585	80	13,7	1110
ENMALLADO HEX. 38 x 39,5	15" x 15,5"	7	1,14	56	25	1.419

PACKING BASES

FORMATO	PULGADAS	PZ/CAJA	M²	CAJA/PLT	PESO/CAJA	PESO/PLT
CHEVRON IZQ./DCHA 17,2 x 7,3 (10)	7" x 3"	48	0,60	60	13,60	830
CHEVRON IZQ./DCHA 17,2 x 7,3 (14)	7" x 3"	34	0,43	60	12	735
ROMBO 15 x 8,5 (10)	6" x 3,3"	42	0,27	132	5,85	788
ROMBO 15 x 8,5 (14)	6" x 3,3"	32	0,20	132	6,6	886

3DHEX

fine **RESISTANCE**
EVOLUTION
EXTRUDED PORCELAIN TILE

3DHEX

- RESISTENCIA A LA HELADA FROST PROOF
- SUPERFICIE BRILLO SURFACE BRIGHTNESS
- REVESTIMIENTO WALL TILE
- DESTONIFICADO ARMONIOSO CONTROLLED DESTONIFICATION
- SIN MANTENIMIENTO NO MAINTENANCE

FORMATOS:
3D HEX. 6,5 x 5,7 - 2,5" x 2,2"
ENM. 3D HEX. 34 x 32,6 - 13,3" x 12,7"



2DHEX

fine **RESISTANCE**
EVOLUTION
EXTRUDED PORCELAIN TILE

2DHEX

- PAVIMENTO DE EXTERIOR OUTDOOR FLOOR TILE
- RESISTENCIA A LA HELADA FROST PROOF
- SUPERFICIE SATINADO GLOSSY SURFACE
- PAVIMENTO DE INTERIOR INDOOR FLOOR TILE
- DESTONIFICADO ARMONIOSO CONTROLLED DESTONIFICATION

FORMATOS:
2D HEX. 13 x 11,4 - 5" x 4"



2DHEX | EVOLUTION EXTRUDED PORCELAIN TILE | *Comfort floor* | PE [Icons]



2D HEX SNOW WHITE
13 x 11,4 (G 51) 5" x 4"

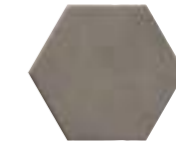

2D HEX GREY
13 x 11,4 (G 51) 5" x 4"

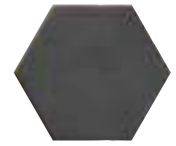

2D HEX CHARCOAL
13 x 11,4 (G 51) 5" x 4"

* Disponible en stock Snow White, Grey y Charcoal.
Disponible en otros colores (pedido mínimo 100 m²)
* Available in stock Snow White, Grey and Charcoal.
Available in other colors (minimum order 100 m²)

3DHEX

EVOLUTION EXTRUDED PORCELAIN TILE | PE [Icons]

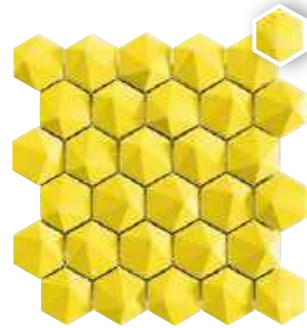

3D HEX. YELLOW
6,5 x 5,7 (G 61) 2,5" x 2,2" m²
ENM. 34 x 32,6 (G 66) 13,3" x 12,7" m²



3D HEX. ORANGE
6,5 x 5,7 (G 61) 2,5" x 2,2" m²
ENM. 34 x 32,6 (G 66) 13,3" x 12,7" m²

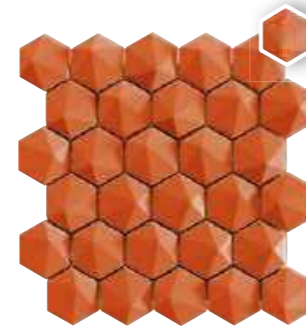

3D HEX. YOLK
6,5 x 5,7 (G 61) 2,5" x 2,2" m²
ENM. 34 x 32,6 (G 66) 13,3" x 12,7" m²

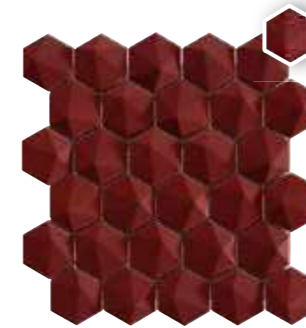

3D HEX. RUBÍ
6,5 x 5,7 (G 61) 2,5" x 2,2" m²
ENM. 34 x 32,6 (G 66) 13,3" x 12,7" m²

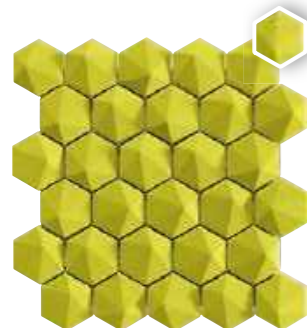

3D HEX. GEM
6,5 x 5,7 (G 61) 2,5" x 2,2" m²
ENM. 34 x 32,6 (G 66) 13,3" x 12,7" m²

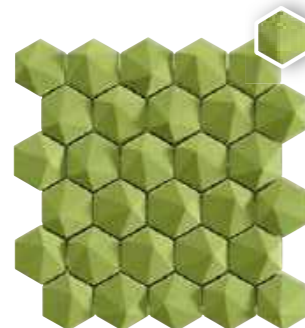

3D HEX. GREEN
6,5 x 5,7 (G 61) 2,5" x 2,2" m²
ENM. 34 x 32,6 (G 66) 13,3" x 12,7" m²

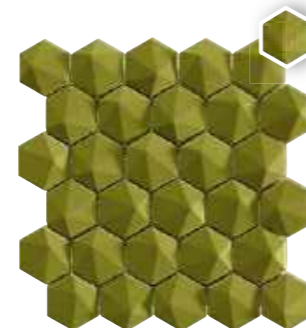

3D HEX. LIME
6,5 x 5,7 (G 61) 2,5" x 2,2" m²
ENM. 34 x 32,6 (G 66) 13,3" x 12,7" m²

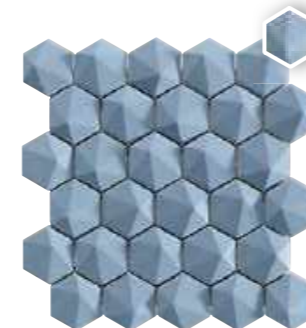

3D HEX. BLUE
6,5 x 5,7 (G 61) 2,5" x 2,2" m²
ENM. 34 x 32,6 (G 66) 13,3" x 12,7" m²



3D HEX. MOON
6,5 x 5,7 (G 61) 2,5" x 2,2" m²
ENM. 34 x 32,6 (G 66) 13,3" x 12,7" m²



3D HEX. SNOW WHITE
6,5 x 5,7 (G 61) 2,5" x 2,2" m²
ENM. 34 x 32,6 (G 66) 13,3" x 12,7" m²



3D HEX. ROPE
6,5 x 5,7 (G 61) 2,5" x 2,2" m²
ENM. 34 x 32,6 (G 66) 13,3" x 12,7" m²



3D HEX. TAN
6,5 x 5,7 (G 61) 2,5" x 2,2" m²
ENM. 34 x 32,6 (G 66) 13,3" x 12,7" m²

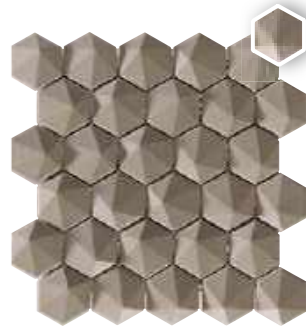

3D HEX. CHESNUT
6,5 x 5,7 (G 61) 2,5" x 2,2" m²
ENM. 34 x 32,6 (G 66) 13,3" x 12,7" m²



3D HEX. ALUMINIUM
6,5 x 5,7 (G 61) 2,5" x 2,2" m²
ENM. 34 x 32,6 (G 66) 13,3" x 12,7" m²



3D HEX. GREY
6,5 x 5,7 (G 61) 2,5" x 2,2" m²
ENM. 34 x 32,6 (G 66) 13,3" x 12,7" m²



3D HEX. SMOKE
6,5 x 5,7 (G 61) 2,5" x 2,2" m²
ENM. 34 x 32,6 (G 66) 13,3" x 12,7" m²



3D HEX. CHARCOAL
6,5 x 5,7 (G 61) 2,5" x 2,2" m²
ENM. 34 x 32,6 (G 66) 13,3" x 12,7" m²

PACKING

FORMATO	PULGADAS	PZ/CAJA	M ²	ML/CAJA	CAJA/PLT	PESO/CAJA	PESO/PLT
HEX. 6,5 x 5,7	2,5" x 2,2"	110	0,41	-	198	6,7	1.342
ENM. 34 x 32,6	13,3" x 12,7"	8	0,89	2,75	36	14,86	549
HEX. 13 x 11,4	5" x 4"	36	0,4	-	98	9,1	909

ENMALLADOS PERSONALIZADOS - CUSTOM ON A MESH

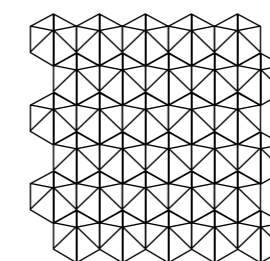

- 1 COLOR**
3D HEX. ENMALLADO
34 x 32,6 (G 66) 13,3" x 12,7" m²
- HASTA 3 COLORES**
3D HEX. ENMALLADO
34 x 32,6 (G 67) 13,3" x 12,7" m²
- MÁS DE 3 COLORES**
3D HEX. ENMALLADO
34 x 32,6 (G 49) 13,3" x 12,7" m²

Disponible en todos los colores
Available in all colors

DUAL

EVOLUTION
EXTRUDED PORCELAIN TILE
EFFECT
MICRO CRAQUELÉ

REVESTIMIENTO
WALL TILE
SUPERFICIE BRILLO
SURFACE BRIGTHNESS

RESIST. A LA HELADA
FROST PROOF
SIN MANTENIMIENTO
NO MAINTENANCE

FORMATOS:
HEX. PIATTO 11,7 x 13,5 - 4,6" x 5,3"
HEX. DUAL 11,7 x 13,5 - 4,6" x 5,3"

TANDEM

EVOLUTION
EXTRUDED PORCELAIN TILE

SUPERFICIE BRILLO
SURFACE BRIGTHNESS

FORMATO:
HEX. IRR. 5 x 20 - 2" x 8"

2 ESPESORES - 2 THICKNESS

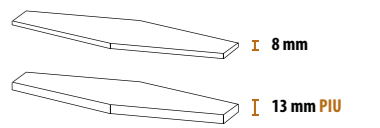

DUAL HEX. PIATTO

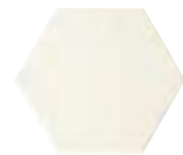

DUAL COTTON HEX. PIATTO
11,7 x 13,5 (G 54) 4,6" x 5,3" **m**



DUAL LATE HEX. PIATTO
11,7 x 13,5 (G 54) 4,6" x 5,3" **m**

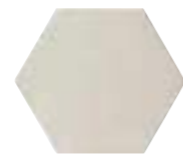

DUAL CENDRE HEX. PIATTO
11,7 x 13,5 (G 54) 4,6" x 5,3" **m**

DUAL HEX. DUAL



DUAL COTTON HEX. DUAL
11,7 x 13,5 (G 50) 4,6" x 5,3" **m**



DUAL LATE HEX. DUAL
11,7 x 13,5 (G 50) 4,6" x 5,3" **m**



DUAL CENDRE HEX. DUAL
11,7 x 13,5 (G 50) 4,6" x 5,3" **m**

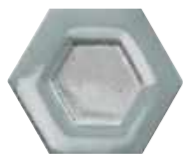

DUAL AQUA HEX. DUAL
11,7 x 13,5 (G 50) 4,6" x 5,3" **m**



DUAL CAPUCHINO HEX. DUAL
11,7 x 13,5 (G 50) 4,6" x 5,3" **m**

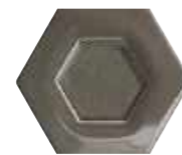

DUAL CHARBON HEX. DUAL
11,7 x 13,5 (G 50) 4,6" x 5,3" **m**

BASE - BASE

3 TEXTURAS DIFERENTES EN LUZ - AZUR 10 - AZABACHE 10
3 DIFFERENT TEXTURES IN LUZ - AZUR 10 - AZABACHE 10



TANDEM AVANTI PIU
DECOR LUZ
5 x 20 (G 64) 2" x 8" **m**



TANDEM AVANTI PIU
DECOR AZUR 10
5 x 20 (G 64) 2" x 8" **m**



TANDEM AVANTI PIU
DECOR AZABACHE 10
5 x 20 (G 64) 2" x 8" **m**



TANDEM AVANTI LUZ
5 x 20 (G 62) 2" x 8" **m**

TANDEM AVANTI PIU LUZ
5 x 20 (G 64) 2" x 8" **m**



TANDEM AVANTI AZUR 10
5 x 20 (G 62) 2" x 8" **m**



TANDEM AVANTI AZABACHE 10
5 x 20 (G 62) 2" x 8" **m**



TANDEM AVANTI AZUR 20
5 x 20 (G 62) 2" x 8" **m**



TANDEM AVANTI AZABACHE 20
5 x 20 (G 62) 2" x 8" **m**



TANDEM AVANTI AZUR 30
5 x 20 (G 62) 2" x 8" **m**



TANDEM AVANTI AZABACHE 30
5 x 20 (G 62) 2" x 8" **m**

DETALLE
DETAIL

ESPESORES - THICKNESS



PACKING

FORMATO	PULGADAS	PZ/CAJA	M ²	CAJA/PLT	PESO/CAJA	PESO/PLT
HEX. PIATTO 11,7 x 13,5	4,6" x 5,3"	40	0,63	66	15,30	1.025
HEX. DUAL 11,7 x 13,5	4,6" x 5,3"	32	0,51	66	12,16	820

PACKING

FORMATO	PULGADAS	PZ/CAJA	M ²	CAJA/PLT	PESO/CAJA	PESO/PLT
HEX. IRR. 5 x 20	2" x 8"	50	0,50	80	12,6	1.022
HEX. IRR. 5 x 20 PIU	2" x 8"	40	0,40	80	12,9	1.046

SHOW

EVOLUTION
EXTRUDED PORCELAIN TILE

- REVESTIMIENTO WALL TILE
- SUPERFICIE MATE MATT SURFACE
- SUPERFICIE BRILLO SURFACE BRIGHTNESS

- RESIST. A LA HELADA FROST PROOF
- RESISTENCIA AL RAYADO SCRATCH RESISTANCE
- RESIST. A ÁCIDOS Y BASES RESIST. TO ACIDS & BASES

- PAV. DE INTERIOR INDOOR FLOOR TILE
- SIN MANTENIMIENTO NO MAINTENANCE
- DESTONIFICADO ARMONIOSO CONTROLLED DESTONIFICATION

FORMATOS:
7,5 x 30 - 3" x 12"
ARROW 7,5 x 25 - 3" x 10"
DART ENM. 29 x 34 - 11,6" x 13,3"



LENS

EVOLUTION
EXTRUDED PORCELAIN TILE

- REVESTIMIENTO WALL TILE
- SUPERFICIE MATE MATT SURFACE
- SUPERFICIE BRILLO SURFACE BRIGHTNESS

- RESIST. A LA HELADA FROST PROOF
- RESISTENCIA AL RAYADO SCRATCH RESISTANCE
- RESIST. A ÁCIDOS Y BASES RESIST. TO ACIDS & BASES

- PAV. DE INTERIOR INDOOR FLOOR TILE
- SIN MANTENIMIENTO NO MAINTENANCE
- DESTONIFICADO ARMONIOSO CONTROLLED DESTONIFICATION

FORMATOS:
ENM. 20,5 x 40 - 8" x 16"
SUPERFICIE CONVEXA



BASES SHOW



SHOW ARROW



SHOW ARROW



PIEZAS ESPECIALES - SPECIAL PIECES

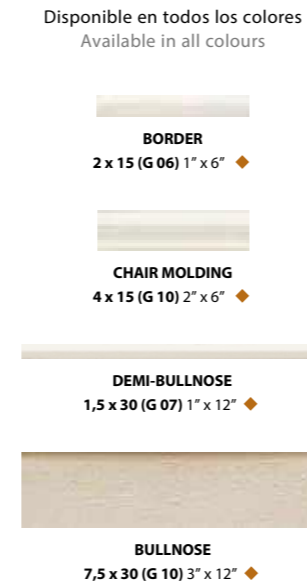

MATE - MATT



BRILLO - GLOSSY

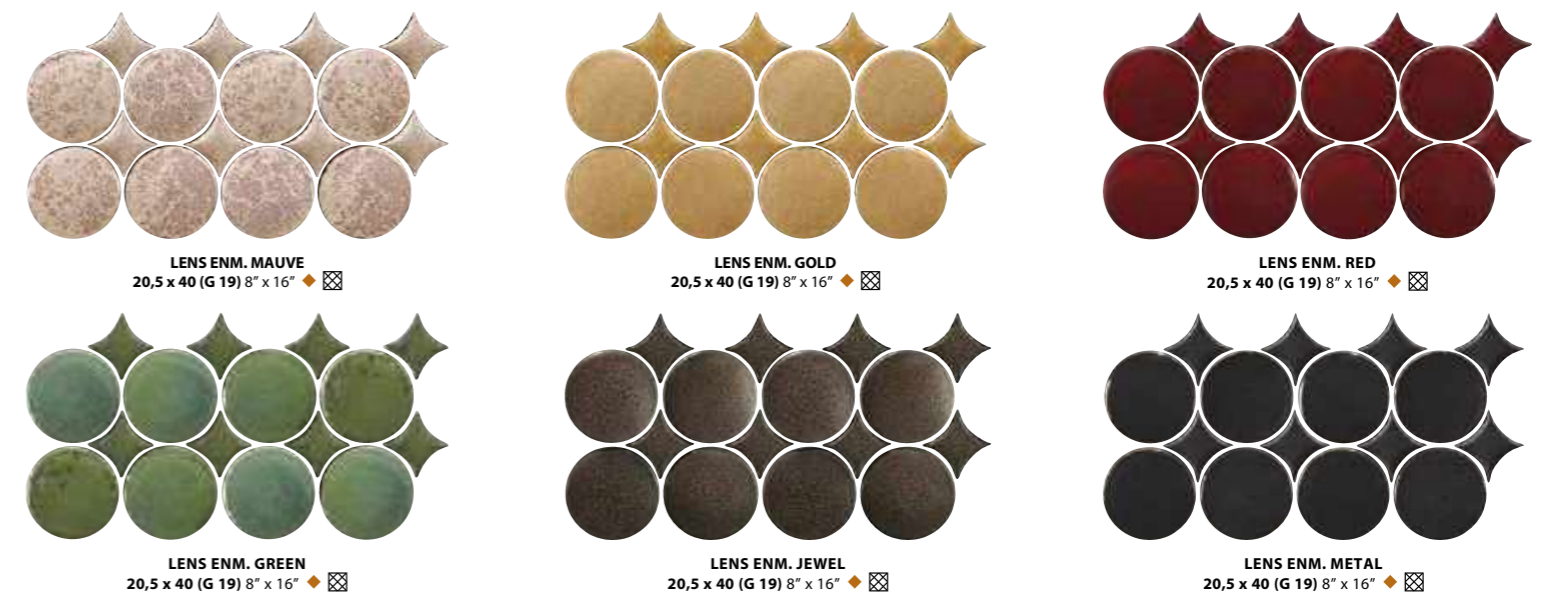

ENMALLADOS - ON A MESH



PACKING BASES

FORMATO	PULGADAS	PZ/CAJA	M ² /CJ.	ML/CJ.	PS/CJ.	CJ./PLT.	PS/PLT.
7,5 x 30	3" x 12"	22	0,5	6,6	10,5	120	1.275
7,5 x 25	3" x 10"	22	0,42	5,5	9	120	1.095
29 x 34	11,6" x 13,3"	11	1,08	3,74	10,5		

PACKING PIEZAS ESPECIALES

FORMATO	PULGADAS	PZ/CAJA	ML/CJ.	PS/CJ.	CJ./PLT.	PS/PLT.
CHAIR MOLDING 4 x 15	2" x 6"	25	3,75	2,35		
BORDER 2 x 15	1" x 6"	50	7,5	2,6		
DEMI-BULLNOSE 1,5 x 30	1" x 12"	50	15	2,2		
BULLNOSE 7,5 x 30	3" x 12"	22	6,6	10,37	120	1.260

PACKING BASES

FORMATO	PULGADAS	PZ/CAJA	M ² /CJ.	ML/CJ.	PS/CJ.	CJ./PLT.	PS/PLT.
20,5 x 40	8" x 16"	5	0,41	2	8,6	112	980

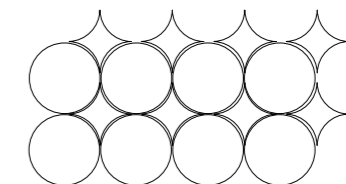

ENMALLADO PERSONALIZADO
2 COLORES
20,5 x 40 (G 19) 8" x 16" ♦

Provenzal

EVOLUTION
EXTRUDED PORCELAIN TILE

- PAV. DE INTERIOR
INDOOR FLOOR TILE
- SUPERFICIE SATINADO
GLOSSY SURFACE
- SIN MANTENIMIENTO
NO MAINTENANCE
- RESIST. A LA HELADA
FROST PROOF
- DESTONIFICADO ARMONIOSO
CONTROLLED DESTONIFICATION

FORMATOS:
PROVENZAL 10,5 x 6,5 - 4" x 2,5"
PROVENZAL 20,5 x 12 - 8" x 4,7"

Cammeo

EVOLUTION
EXTRUDED PORCELAIN TILE

- REVESTIMIENTO
WALL TILE
- SUPERFICIE SATINADO
GLOSSY SURFACE
- SIN MANTENIMIENTO
NO MAINTENANCE
- RESIST. A LA HELADA
FROST PROOF
- DESTONIFICADO ARMONIOSO
CONTROLLED DESTONIFICATION

FORMATOS:
ENM. PROVENZAL
38,5 x 42 - 15" x 16,5"



4 TEXTURAS DIFERENTES
4 DIFFERENT TEXTURES

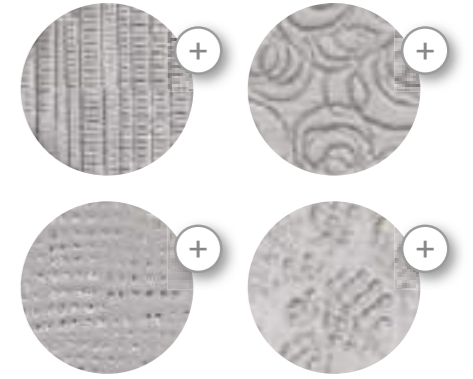

Disponibles en todos los colores · Available in all colors

BASE · BASE

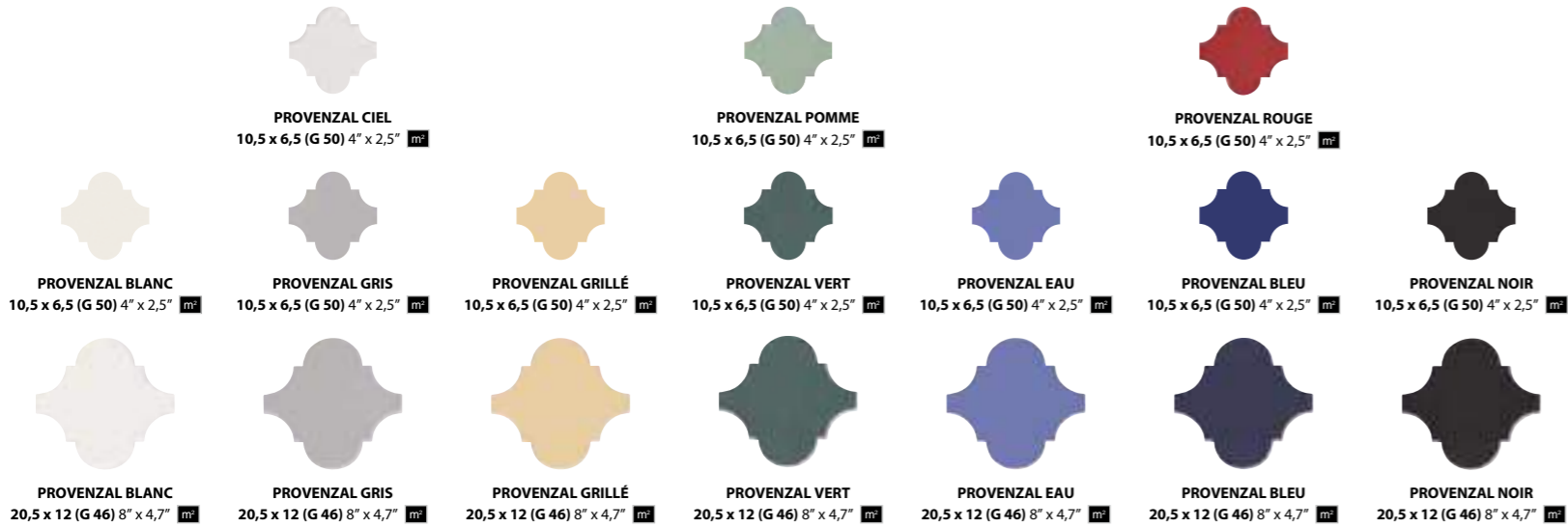

ENMALLADOS · ON A MESH



ENMALLADOS PERSONALIZADOS · CUSTOM ON A MESH

Disponibles en todos los colores · Available in all colors



PACKING BASES

FORMATO	PULGADAS	PZ/CAJA	M ²	CAJA/PLT	PESO/CAJA	PESO/PLT
PROVENZAL 10,5 x 6,5	4" x 2,5"	60	0,41	128	8,5	1.102
PROVENZAL 20,5 x 12	8" x 4,7"	24	0,59	60	11,65	713

PACKING BASES

FORMATO	PULGADAS	PZ/CAJA	M ²	CAJA/PLT	PESO/CAJA	PESO/PLT
ENM. 38,5 x 42	15" x 16,5"	7	1,14	56	24,6	1.396

PACKING BASES

FORMATO	PULGADAS	PZ/CAJA	M ²	CAJA/PLT	PESO/CAJA	PESO/PLT
ENM. PROVENZAL 38,5 x 42	15" x 16,5"	7	1,14	56	24,7	1.396

Arabesco

EVOLUTION
EXTRUDED PORCELAIN TILE

- REVESTIMIENTO WALL TILE
- SUPERFICIE BRILLO SURFACE BRIGTNES
- VOLUMEN VOLUME

FORMATO:
14,5 x 23,5 - 5,7" x 9,2"

casella

EVOLUTION
EXTRUDED PORCELAIN TILE

- REVESTIMIENTO WALL TILE
- SUPERFICIE BRILLO SURFACE BRIGTNES
- VOLUMEN VOLUME

FORMATOS:
14,5 x 23,5 - 9,2" x 5,7"
5,5 x 23,5 - 2,1" x 5,7"



COLORES · COLORS

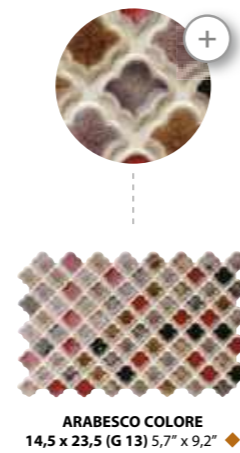
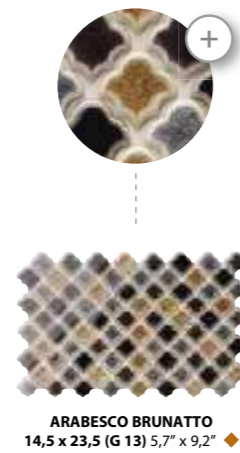
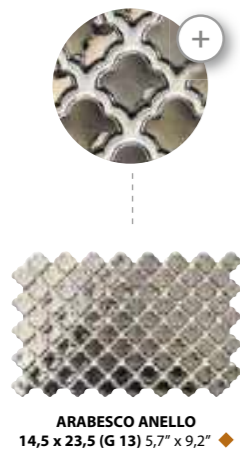

COLORES · COLORS

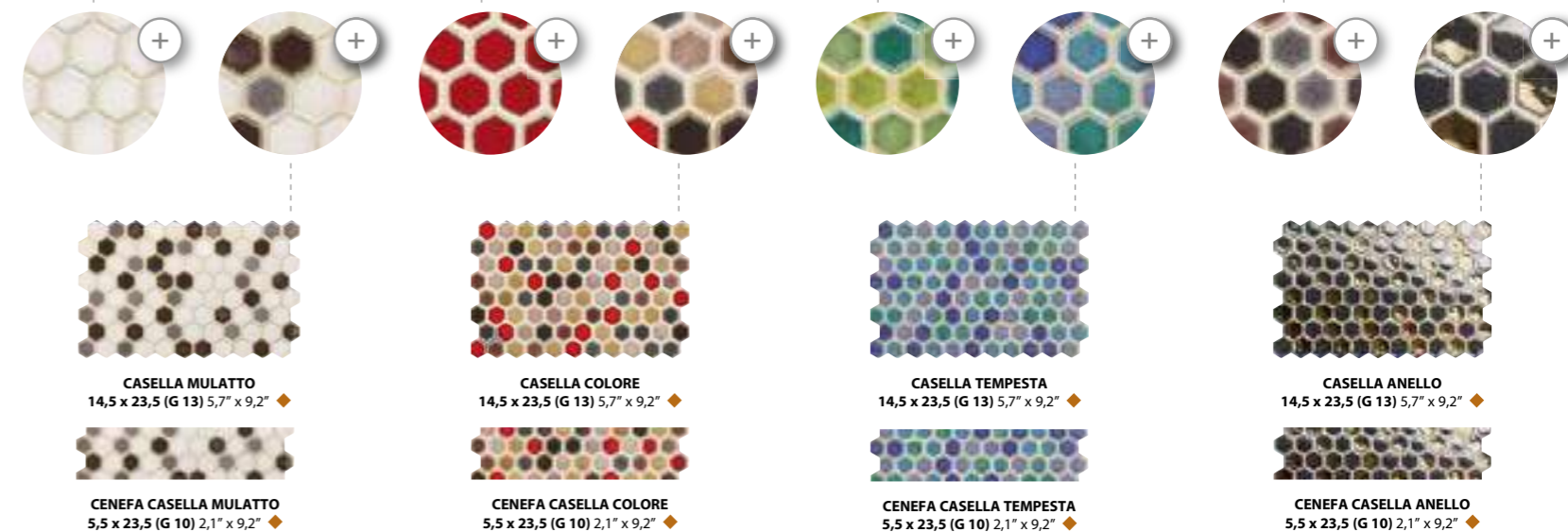
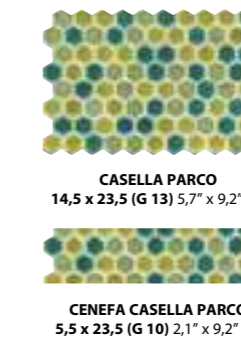
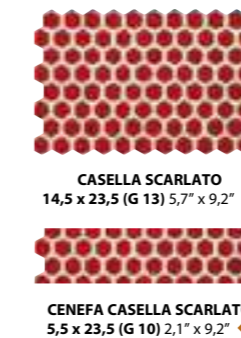
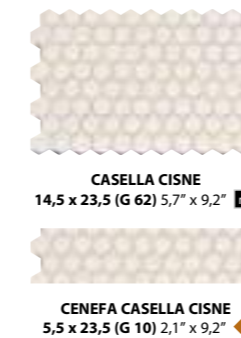

PACKING

FORMATO	PULGADAS	PZ/CAJA	ML	CAJA/PLT	PESO/CAJA
ARABESCO 23,5 x 14,5	9,2" x 5,7"	20	4,7	60	16

PACKING DECORACIÓN

FORMATO	PULGADAS	PZ/CAJA	ML	CAJA/PLT	PESO/CAJA
CASELLA 23,5 x 14,5	9,2" x 5,7"	20	4,7	60	16
CENEFA 5,5 x 23,5	2,1" x 9"	20	4,7	60	5,7

NOVECENTO



FORMATO

13 x 39 - 5" x 15"
13 x 13 - 5" x 5"
HEX. 13 x 13 - 5" x 5"
6,5 x 13 - 3" x 5"



BASE - BASE

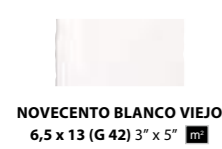

NOVECENTO BLANCO VIEJO
6,5 x 13 (G 42) 3" x 5" m²



NOVECENTO BLANCO VIEJO
13 x 13 (G 42) 5" x 5" m²



HEX. NOVECENTO BLANCO VIEJO
13 x 13 (G 42) 5" x 5" m²



NOVECENTO BLANCO SILENCIO
13 x 13 (G 42) 5" x 5" m²



HEX. NOVECENTO BLANCO SILENCIO
13 x 13 (G 42) 5" x 5" m²



NOVECENTO CANELA
6,5 x 13 (G 42) 3" x 5" m²



NOVECENTO CANELA
13 x 13 (G 42) 5" x 5" m²



NOVECENTO CAMEL
6,5 x 13 (G 42) 3" x 5" m²



NOVECENTO CAMEL
13 x 13 (G 42) 5" x 5" m²



NOVECENTO BURDEOS
6,5 x 13 (G 42) 3" x 5" m²



NOVECENTO BURDEOS
13 x 13 (G 42) 5" x 5" m²



NOVECENTO AGUAMARINA
3 x 3 (G 03) 1" x 1" m²

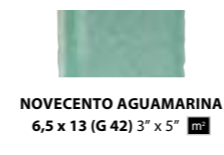

NOVECENTO AGUAMARINA
6,5 x 13 (G 42) 3" x 5" m²



NOVECENTO AGUAMARINA
13 x 13 (G 42) 5" x 5" m²



NOVECENTO VERDÍN
3 x 3 (G 03) 1" x 1" m²



NOVECENTO VERDÍN
6,5 x 13 (G 42) 3" x 5" m²



NOVECENTO VERDÍN
13 x 13 (G 42) 5" x 5" m²

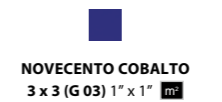

NOVECENTO COBALTO
3 x 3 (G 03) 1" x 1" m²



NOVECENTO COBALTO
6,5 x 13 (G 42) 3" x 5" m²



NOVECENTO COBALTO
13 x 13 (G 42) 5" x 5" m²

PIEZAS ESPECIALES - SPECIAL PIECES

Disponible en todos los colores - Available in all colors



TACO NOVECENTO
3 x 3 (G 03) 1" x 1" m²



BORDURA NOVECENTO
4 x 13 (G 10) 2" x 5" m²



MOLDURA NOVECENTO
5,5 x 13 (G 10) 2" x 5" m²

PACKING BASES

FORMATO	PULGADAS	PZ/CAJA	M ²	CAJA/PLT	PESO/CAJA	PESO/PLT
13 x 39	5" x 15"	20	1	72	19,48	1,417
13 x 13	5" x 5"	30	0,5	102	10,78	1,114
6,5 x 13	3" x 5"	60	0,5	102	11,26	1,163

PACKING PIEZAS ESPECIALES

FORMATO	PULGADAS	PZ/CAJA	ML	CAJA/PLT	PESO/CAJA
TACO 3 x 3	1" x 1"	100	3	150	1,8
BORDURA 4 x 13	2" x 5"	18	2,34	60	1,92
MOLDURA 5,5 x 13	2" x 5"	18	2,34	60	2,15



OUT
Solución para el exterior de la piscina
Special pieces for outside pool

PIEZAS ESPECIALES PARA UN ACABADO PERFECTO Y COORDINADO
SPECIAL PIECES FOR A PERFECT FINISH

IN
Solución para el vaso de piscina
Special pieces for inside pool

REVESTIMIENTO ESPECIAL PARA VASO DE PISCINA POOL PORC.
SPECIAL TILES FOR THE INTERIOR OF THE SWIMMING POOL IN PORCELAIN FINISH



Natucer ofrece soluciones integrales para piscinas.
Un paquete completo formado por **DOS CONCEPTOS**
diferenciados entre sí.
La fórmula perfecta: dentro y fuera (IN & OUT)

Natucer offers all kind of solutions for
swimming pool projects.
The perfect and most complete concept: IN & OUT

TERRACE + POOL INTERIOR
IN&OUT SOLUTIONS

TIPOS DE PISCINA SEGÚN SU CORONACIÓN · DIFFERENT CROWNING SYSTEM SWIMMING POOLS



Ver serie completa en el catálogo NATURPOOL o en la web <https://www.natucer.es/es/soluciones-ceramicas/soluciones-piscinas>
See complete series in the NATURPOOL catalog or on the web <https://www.natucer.es/en/soluciones-ceramicas/soluciones-piscinas>

CANALIZACIÓN CON GRATTING · GRATTING CHANNEL

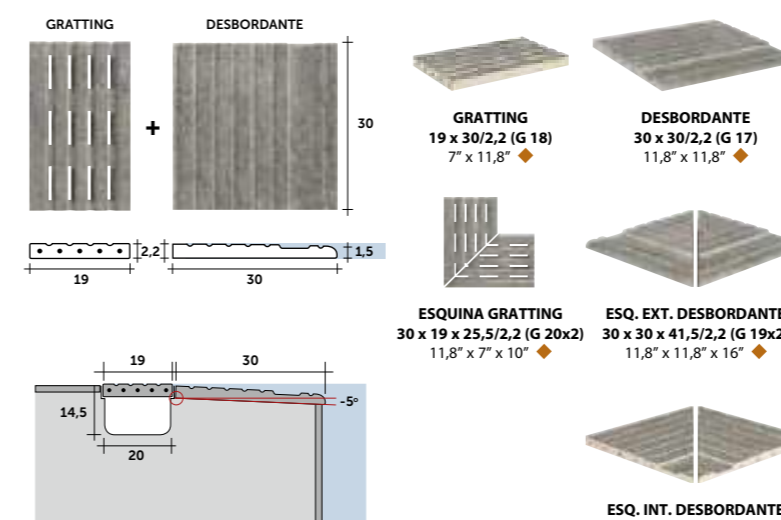

CANALIZACIÓN CON REJILLA · GRILL CHANNEL

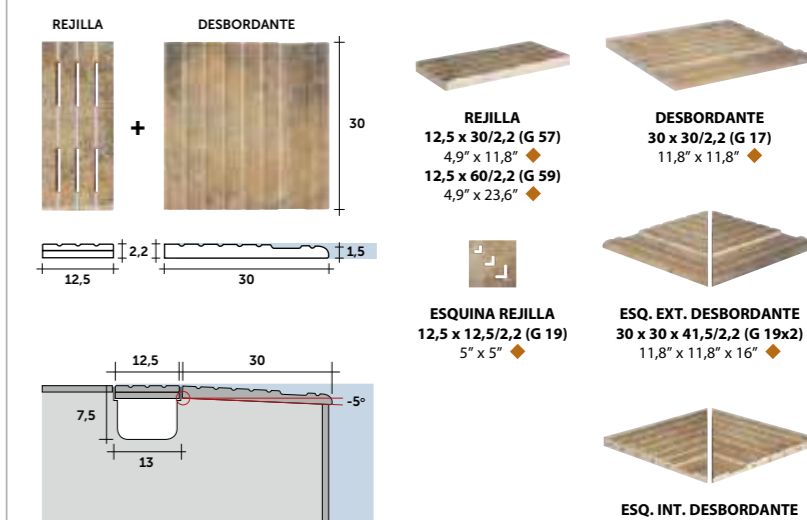



CORONACIÓN CON BORDE DE PISCINA - CROWNED WITH POOL BORDER TILES

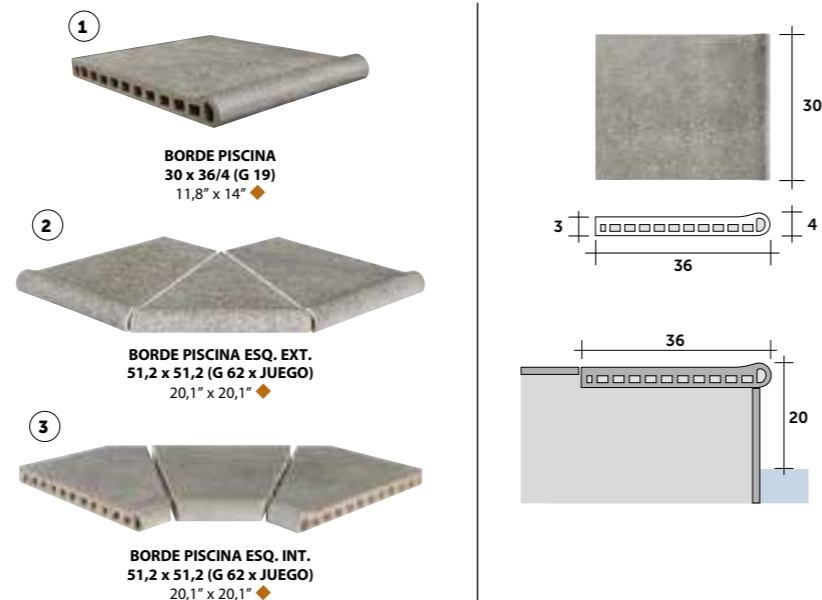

CORONACIÓN CON PELDAÑO 120 - CROWNED WITH 120 CM STEP

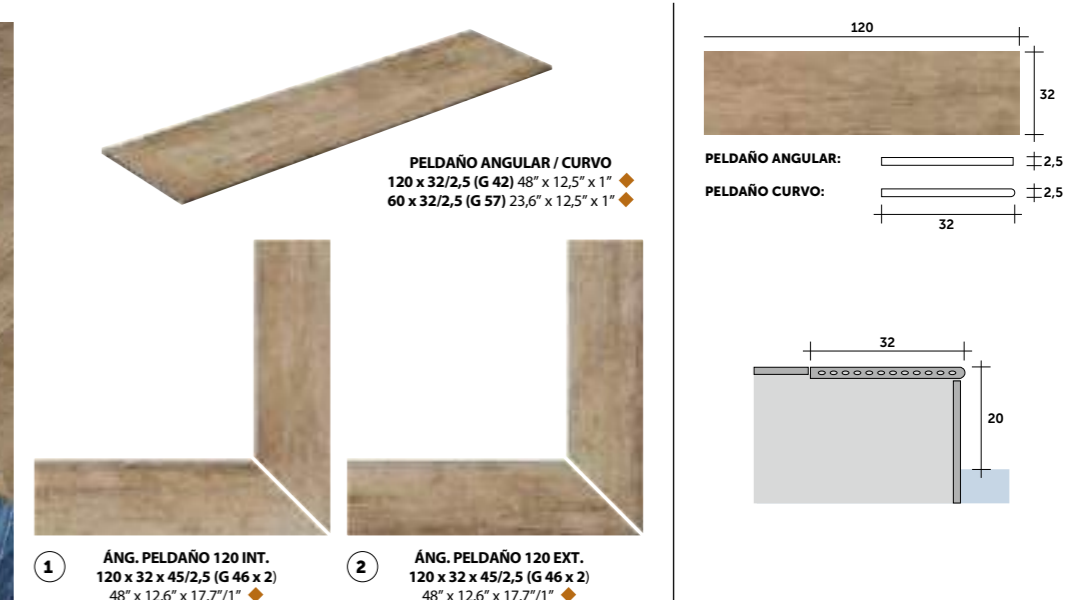

bamboo

EVOLUTION
EXTRUDED PORCELAIN TILE

PE GRES EXTR. PORCELÁNICO
PORCELAIN EXTRUDED TILE

SUPERFICIE BRILLO
SURFACE BRIGHTNESS

SUPERFICIE MATE
MATT SURFACE

RESIST. A LA HELADA
FROST PROOF

RESIST. A ACIDOS Y BASES
RESIST. TO ACIDS & BASES

SIN MANTENIMIENTO
NO MAINTENANCE

FORMATOS:

8 x 30,5 - 3,1" x 11,9"
8 x 6 - 3,1" x 2,4"
5 x 61 - 2" x 23,8"
5 x 30,5 - 2" x 11,9"



PIEZAS DE 8 CM



COVER BAMBOO FROST
1,5 x 8 (G 15) 1" x 3" ◆



COVER BAMBOO YOLK
1,5 x 8 (G 15) 1" x 3" ◆



COVER BAMBOO RUBI
1,5 x 8 (G 15) 1" x 3" ◆



COVER BAMBOO GEM
1,5 x 8 (G 15) 1" x 3" ◆



COVER BAMBOO DARK
1,5 x 8 (G 15) 1" x 3" ◆



BAMBOO FROST
8 x 30,5 (G 31) 3,1" x 11,9" ◆



BAMBOO YOLK
8 x 30,5 (G 17) 3,1" x 11,9" ◆



BAMBOO RUBI
8 x 30,5 (G 17) 3,1" x 11,9" ◆



BAMBOO GEM
8 x 30,5 (G 17) 3,1" x 11,9" ◆



BAMBOO DARK
8 x 30,5 (G 31) 3,1" x 11,9" ◆



BAMBOO FROST
8 x 6 (G 10) 3,1" x 2,4" ◆



BAMBOO YOLK
8 x 6 (G 11) 3,1" x 2,4" ◆



BAMBOO RUBI
8 x 6 (G 11) 3,1" x 2,4" ◆



BAMBOO GEM
8 x 6 (G 11) 3,1" x 2,4" ◆



BAMBOO DARK
8 x 6 (G 10) 3,1" x 2,4" ◆



BAMBOO METAL
2 x 8 (G 16) 1" x 3" ◆

ALZADO RAISED

Montaje interior
Montaje interior



cover (15 mm.)
tapa superior

tubo (35 mm.)

arandella intermedia

60

72

49,5

50

80

Tapa superior
Tapa superior

Arandella intermedia
Shim

72

48

50

80

PACKING BASES

FORMATO	PULGADAS	M ² /CAJA	ML / CAJA	PIEZAS / CAJA	KG / PIEZA	KG / CAJA	CAJAS / PALET	KG / PALET
BAMBOO 8 x 30,5	3,1" x 11,9"	0,613	2,44	8	2,5	20	28	586
BAMBOO 8 x 6	3,1" x 2,4"	0,12	0,96	16	0,25	4	60	250
COVER 1,5 x 8	1" x 3"	0,03	2	25	0,14	3,6	60	230

PACKING BASES

FORMATO	PULGADAS	M ² /CAJA	ML / CAJA	PIEZAS / CAJA	KG / PIEZA	KG / CAJA	CAJAS / PALET	KG / PALET
BAMBOO 5 x 61	2" x 23,8"	0,574	3,66	6	2,31	13,86	36	520
BAMBOO 5 x 30,5	2" x 11,9"	0,287	5,49	18	1,11	20	28	580
BAMBOO 5 x 3,2	2" x 1,2"	0,04	1,25	25	0,11	2,85	60	200
COVER 1,4 x 5	1" x 2"	0,02	1,25	25	0,052	1,4	60	200

PIEZAS DE 5 CM



COVER BAMBOO FROST
1,4 x 5 (G 14) 1" x 2" ◆



COVER BAMBOO YOLK
1,4 x 5 (G 14) 1" x 2" ◆



COVER BAMBOO RUBI
1,4 x 5 (G 14) 1" x 2" ◆



COVER BAMBOO GEM
1,4 x 5 (G 14) 1" x 2" ◆



COVER BAMBOO DARK
1,4 x 5 (G 14) 1" x 2" ◆



BAMBOO FROST
5 x 61 (G 17) 2" x 23,8" ◆



BAMBOO YOLK
5 x 61 (G 19) 2" x 23,8" ◆



BAMBOO RUBI
5 x 61 (G 19) 2" x 23,8" ◆



BAMBOO GEM
5 x 61 (G 19) 2" x 23,8" ◆



BAMBOO DARK
5 x 61 (G 17) 2" x 23,8" ◆



BAMBOO FROST
5 x 30,5 (G 13) 2" x 11,9" ◆



BAMBOO YOLK
5 x 30,5 (G 16) 2" x 11,9" ◆



BAMBOO RUBI
5 x 30,5 (G 16) 2" x 11,9" ◆



BAMBOO GEM
5 x 30,5 (G 16) 2" x 11,9" ◆



BAMBOO DARK
5 x 30,5 (G 13) 2" x 11,9" ◆



BAMBOO FROST
3,2 x 5 (G 06) 1,2" x 2" ◆



BAMBOO YOLK
3,2 x 5 (G 08) 1,2" x 2" ◆



BAMBOO RUBI
3,2 x 5 (G 08) 1,2" x 2" ◆



BAMBOO GEM
3,2 x 5 (G 08) 1,2" x 2" ◆



BAMBOO DARK
3,2 x 5 (G 06) 1,2" x 2" ◆

ALZADO RAISED

Montaje interior
Montaje interior



cover (unido con silicona)

tubo (16 mm.)

arandella intermedia

610

30

50

Arandella intermedia
Shim

45

22

37

18

32

cube

EVOLUTION
EXTRUDED PORCELAIN TILE

RE GRES EXTR. PORCELÁNICO
PORCELAIN EXTRUDED TILE

S SUPERFICIE BRILLO
SURFACE BRIGTNES

M SUPERFICIE MATE
MATT SURFACE

R RESIST. A LA HELADA
FROST PROOF

A RESIST. A ÁCIDOS Y BASES
RESIST. TO ACIDS & BASES

S SIN MANTENIMIENTO
NO MAINTENANCE

FORMATOS:

8 x 30,5 - 3,1" x 11,9"
8 x 6 - 3,1" x 2,4"
5 x 61 - 2" x 23,8"
5 x 30,5 - 2" x 11,9"

bamboo & cube

KIT DE MONTAJE



KIT DE MONTAJE HORIZONTAL con tubo de acero inoxidable
KIT DE MONTAJE HORIZONTAL con tubo de acero inoxidable

Bamboo & Cube

MONTAJE HORIZONTAL 5 CM. MONTAJE HORIZONTAL 5 CM.

Incluido en el KIT (G18)
Included in the KIT

- 1.-Taco pared (2 unidades)
Taco wall (2 units)
- 2.-Tornillo pared (2 unidades)
Top wall (2 units)
- 3.-Embelecedor (2 unidades) (para Bamboo)
Trim (2 units)
- 3.-Embelecedor (2 unidades) (para Cube)
Trim (2 units)
- 4.-Tornillo prisionero (2 unidades)
Setscrew (2 units)

No incluido en el KIT
Not included in the KIT

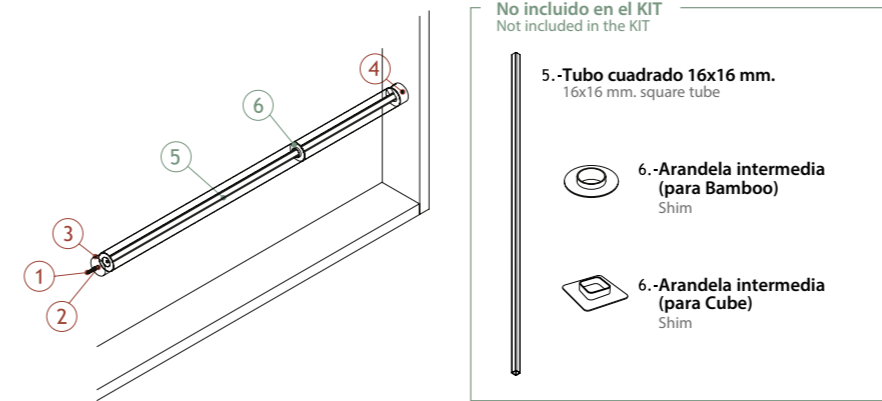

5.-Tubo cuadrado 16x16 mm.
16x16 mm. square tube

6.-Arandela intermedia (para Bamboo)
Shim

6.-Arandela intermedia (para Cube)
Shim

REFERENCIA	CARACTERÍSTICAS	Nº PIEZAS NECESARIAS (NO INCLUIDAS EN KIT)
TUBO HORIZONTAL BAMBOO 5 cm. 122 (G 31)	Tubo cuadrado de 16x16 mm. mecanizado, con una altura de 1,225 metros.	x2 + x1 x4 + x3
TUBO HORIZONTAL BAMBOO 5 cm. 153 (G 17)	Tubo cuadrado de 16x16 mm. mecanizado, con una altura de 1,530 metros.	x2 + x1 + x2 x5 + x4
TUBO HORIZONTAL BAMBOO 5 cm. 183 (G 18)	Tubo cuadrado de 16x16 mm. mecanizado, con una altura de 1,835 metros.	x3 + x2 x6 + x5
RELACIÓN ALTURA DE PIEZAS		
CUBE 4,2 x 61 cm.	BAMBOO 5 x 61 cm.	5x61 cm. = equivale a 2 = 5x30,5 cm. + BAMBOO 5 x 30,5 cm.

PIEZAS DE 5 CM



ALZADO RAISED

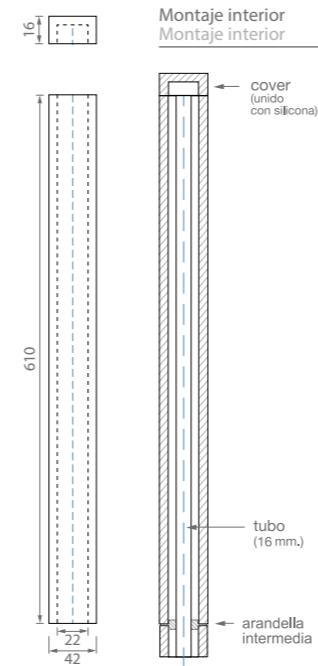

Arandela intermedia
Shim

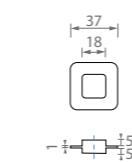

MÚLTIPLES APLICACIONES
VARIOUS APPLICATIONS

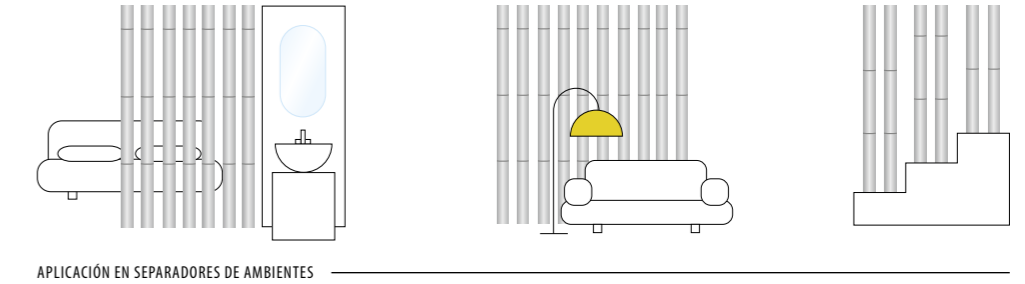
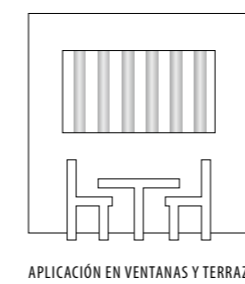
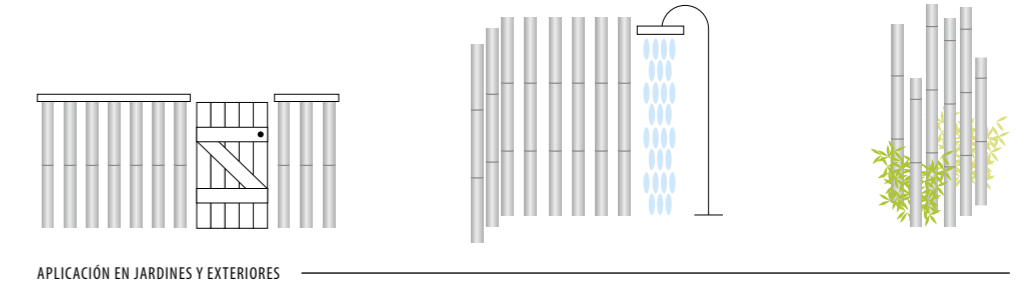
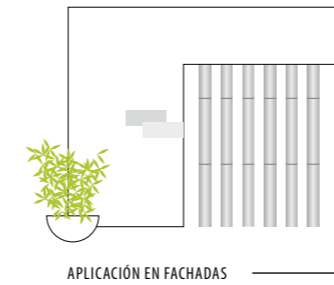

PACKING BASES

FORMATO	PULGADAS	M ² /CAJA	ML / CAJA	PIEZAS / CAJA	KG / PIEZA	KG / CAJA	CAJAS / PALET	KG / PALET
CUBE 4,2 x 61	2" x 23,8"	0,615	3,6	6	2,4	14,4	36	530
CUBE 4,2 x 2,4	2" x 1"	0,025	1,05	25	0,095	2,48	60	160
COVER 1,6 x 4,2	1" x 2"	0,017	1,05	25	0,052	1,4	60	98

KIT DE MONTAJE PIEZAS 8 cm. con tubo de acero inoxidable
KIT DE MONTAJE PIEZAS 8 cm. con tubo de acero inoxidable

Bamboo & Cube

MONTAJE LIBRE MONTAJE LIBRE

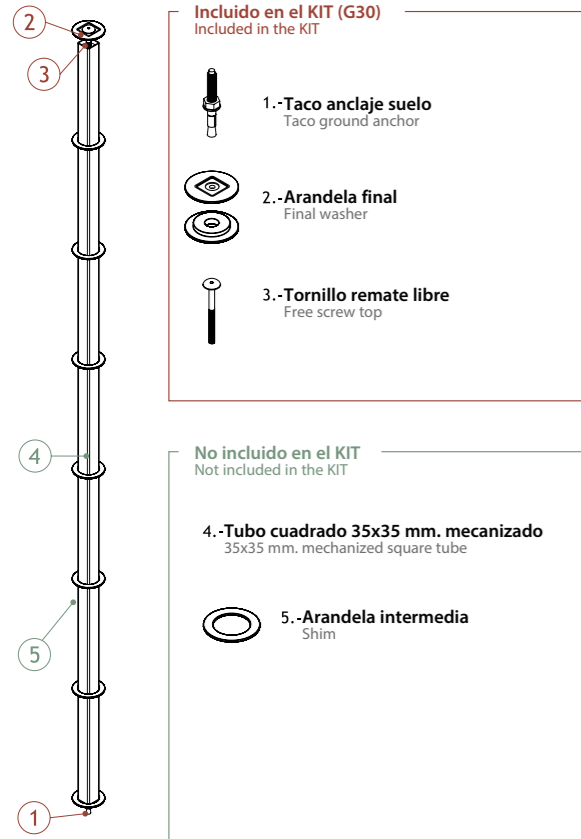

- Incluido en el KIT (G30)**
Included in the KIT
- 1.-Taco anclaje suelo
Taco ground anchor
 - 2.-Arandela final
Final washer
 - 3.-Tornillo remate libre
Free screw top

- No incluido en el KIT
Not included in the KIT
- 4.-Tubo cuadrado 35x35 mm. mecanizado
35x35 mm. mechanized square tube
 - 5.-Arandela intermedia
Shim

REFERENCIA	CARACTERÍSTICAS	ALTURA (SUMA PIEZAS Y ARANDELAS)	Nº PIEZAS NECESARIAS (NO INCLUIDAS EN KIT)	ARANDELA (INCLUIDA)
TUBO VERTICAL BAMBOO 8 cm. 150 (G 25)	Tubo cuadrado de 35x35 mm. mecanizado, con una altura de 1,500 metros.	Cortando 1,500 metros.	x4 + x1 [h: 26,5cm.] + x5	x1
		Desde 1,540 metros.	x5 + x5	x1
		Hasta 1,573 metros.	x5 + x1 [h: 3cm.] + x6	x1
TUBO VERTICAL BAMBOO 8 cm. 180 (G 57)	Tubo cuadrado de 35x35 mm. mecanizado, con una altura de 1,805 metros.	Cortando 1,808 metros.	x5 + x1 [h: 26,5cm.] + x6	x1
		Desde 1,848 metros.	x6 + x6	x1
		Hasta 1,881 metros.	x6 + x1 [h: 3cm.] + x7	x1
TUBO VERTICAL BAMBOO 8 cm. 211 (G 38)	Tubo cuadrado de 35x35 mm. mecanizado, con una altura de 2,115 metros.	Cortando 2,121 metros.	x6 + x1 [h: 27cm.] + x7	x1
		Desde 2,156 metros.	x7 + x7	x1
		Hasta 2,189 metros.	x7 + x1 [h: 3cm.] + x8	x1
TUBO VERTICAL BAMBOO 8 cm. 242 (G 58)	Tubo cuadrado de 35x35 mm. mecanizado, con una altura de 2,425 metros.	Cortando 2,429 metros.	x7 + x1 [h: 27cm.] + x8	x1
		Desde 2,464 metros.	x8 + x8	x1
		Hasta 2,497 metros.	x8 + x1 [h: 3cm.] + x9	x1
TUBO VERTICAL BAMBOO 8 cm. 273 (G 56)	Tubo cuadrado de 35x35 mm. mecanizado, con una altura de 2,730 metros.	Cortando 2,737 metros.	x8 + x1 [h: 27cm.] + x9	x1
		Desde 2,772 metros.	x9 + x9	x1
		Hasta 2,805 metros.	x9 + x1 [h: 3cm.] + x10	x1

RELACIÓN ALTURA DE PIEZAS

BAMBOO 8 x 30,5 cm. 8x30,5 cm. = equivale a 5 = 8x6 cm. **BAMBOO** 8 x 6 cm.

MONTAJE A TECHO MONTAJE A TECHO

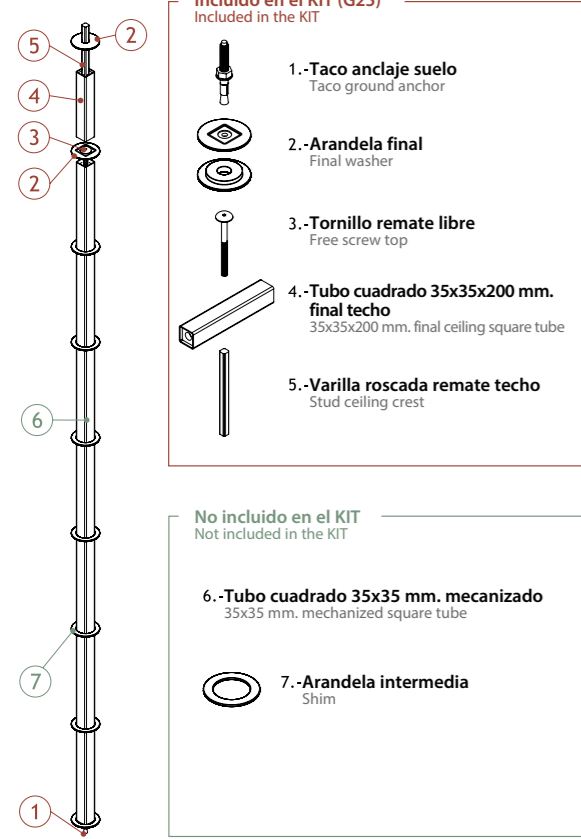

- Incluido en el KIT (G25)**
Included in the KIT
- 1.-Taco anclaje suelo
Taco ground anchor
 - 2.-Arandela final
Final washer
 - 3.-Tornillo remate libre
Free screw top
 - 4.-Tubo cuadrado 35x35x200 mm. final techo
35x35x200 mm. final ceiling square tube
 - 5.-Varilla rosca remate techo
Stud ceiling crest

- No incluido en el KIT
Not included in the KIT
- 6.-Tubo cuadrado 35x35 mm. mecanizado
35x35 mm. mechanized square tube
 - 7.-Arandela intermedia
Shim

REFERENCIA	CARACTERÍSTICAS	ALTURA (SUMA PIEZAS Y ARANDELAS)	Nº PIEZAS NECESARIAS (NO INCLUIDAS EN KIT)	ARANDELA (INCLUIDA)
TUBO VERTICAL BAMBOO 8 cm. 150 (G 25)	Tubo cuadrado de 35x35 mm. mecanizado, con una altura de 1,500 metros.	Cortando 1,808 metros.	x5 + x1 [h: 26,5cm.] + x6	x1
		Desde 1,848 metros.	x6 + x6	x1
		Hasta 1,881 metros.	x6 + x1 [h: 3cm.] + x7	x1
TUBO VERTICAL BAMBOO 8 cm. 180 (G 57)	Tubo cuadrado de 35x35 mm. mecanizado, con una altura de 1,805 metros.	Cortando 2,121 metros.	x6 + x1 [h: 27cm.] + x7	x1
		Desde 2,156 metros.	x7 + x7	x1
		Hasta 2,189 metros.	x7 + x1 [h: 3cm.] + x8	x1
TUBO VERTICAL BAMBOO 8 cm. 211 (G 38)	Tubo cuadrado de 35x35 mm. mecanizado, con una altura de 2,115 metros.	Cortando 2,429 metros.	x7 + x1 [h: 27cm.] + x8	x1
		Desde 2,464 metros.	x8 + x8	x1
		Hasta 2,497 metros.	x8 + x1 [h: 3cm.] + x9	x1
TUBO VERTICAL BAMBOO 8 cm. 242 (G 58)	Tubo cuadrado de 35x35 mm. mecanizado, con una altura de 2,425 metros.	Cortando 2,737 metros.	x8 + x1 [h: 27cm.] + x9	x1
		Desde 2,772 metros.	x9 + x9	x1
		Hasta 2,805 metros.	x9 + x1 [h: 3cm.] + x10	x1
TUBO VERTICAL BAMBOO 8 cm. 273 (G 56)	Tubo cuadrado de 35x35 mm. mecanizado, con una altura de 2,730 metros.	Cortando 3,045 metros.	x9 + x1 [h: 27cm.] + x10	x1
		Desde 3,080 metros.	x10 + x10	x1
		Hasta 3,113 metros.	x10 + x1 [h: 3cm.] + x10	x1

RELACIÓN ALTURA DE PIEZAS

BAMBOO 8 x 30,5 cm. 8x30,5 cm. = equivale a 5 = 8x6 cm. **BAMBOO** 8 x 6 cm.

KIT DE MONTAJE PIEZAS 5 cm. con tubo de acero inoxidable
KIT DE MONTAJE PIEZAS 5 cm. con tubo de acero inoxidable

Bamboo & Cube

MONTAJE LIBRE MONTAJE LIBRE

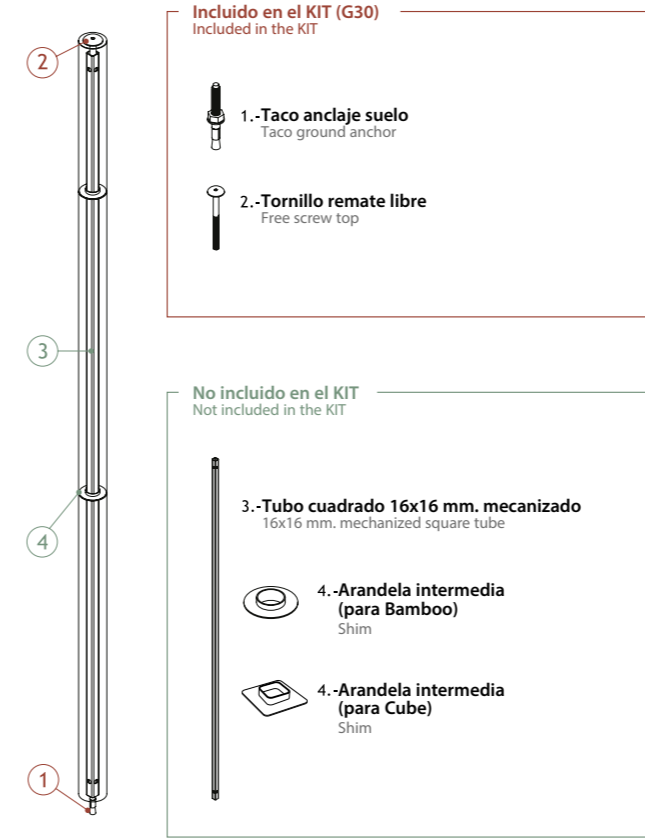

- Incluido en el KIT (G30)**
Included in the KIT
- 1.-Taco anclaje suelo
Taco ground anchor
 - 2.-Tornillo remate libre
Free screw top

- No incluido en el KIT
Not included in the KIT
- 3.-Tubo cuadrado 16x16 mm. mecanizado
16x16 mm. mechanized square tube
 - 4.-Arandela intermedia (para Bamboo)
Shim
 - 4.-Arandela intermedia (para Cube)
Shim

REFERENCIA	CARACTERÍSTICAS	ALTURA (SUMA PIEZAS Y ARANDELAS)	Nº PIEZAS NECESARIAS (NO INCLUIDAS EN KIT)
TUBO VERTICAL BAMBOO 5 cm. 150 (G 25)	Tubo cuadrado de 16x16 mm. mecanizado, con una altura de 1,500 metros.	Desde 1,527 metros.	x2 + x1 + x2
		Hasta 1,529 metros.	x5 + x4
TUBO VERTICAL BAMBOO 5 cm. 180 (G 57)	Tubo cuadrado de 16x16 mm. mecanizado, con una altura de 1,805 metros.	Desde 1,832 metros.	x3 + x2 x3 + x2
		Hasta 1,835 metros.	x6 + x5
TUBO VERTICAL BAMBOO 5 cm. 211 (G 38)	Tubo cuadrado de 16x16 mm. mecanizado, con una altura de 2,115 metros.	Desde 2,138 metros.	x3 + x1 + x3
		Hasta 2,141 metros.	x7 + x6
TUBO VERTICAL BAMBOO 5 cm. 242 (G 58)	Tubo cuadrado de 16x16 mm. mecanizado, con una altura de 2,425 metros.	Desde 2,443 metros.	x4 + x3 x4 + x3
		Hasta 2,447 metros.	x8 + x7
TUBO VERTICAL BAMBOO 5 cm. 273 (G 56)	Tubo cuadrado de 16x16 mm. mecanizado, con una altura de 2,730 metros.	Desde 2,749 metros.	x4 + x1 + x4
		Hasta 2,753 metros.	x9 + x8

RELACIÓN ALTURA DE PIEZAS

CUBE 4,2 x 61 cm. **BAMBOO** 5 x 61 cm. 5x61 cm. = equivale a 2 = 5x30,5 cm. **BAMBOO** 5 x 30,5 cm.

MONTAJE A TECHO MONTAJE A TECHO



- Incluido en el KIT (G25)**
Included in the KIT
- 1.-Taco anclaje suelo
Taco ground anchor
 - 2.-Arandela de tope
Thrust washer
 - 3.-Tornillo hexagonal
Hexagonal screw
 - 4.-Tubo cuadrado 16x16x200 mm. final techo
16x16x200 mm. final ceiling square tube
 - 5.-Varilla rosca remate techo
Stud ceiling crest

- No incluido en el KIT
Not included in the KIT
- 6.-Tubo cuadrado 16x16 mm. mecanizado
16x16 mm. mechanized square tube
 - 7.-Arandela intermedia (para Bamboo)
Shim
 - 7.-Arandela intermedia (para Cube)
Shim

REFERENCIA	CARACTERÍSTICAS	ALTURA (SUMA PIEZAS Y ARANDELAS)	Nº PIEZAS NECESARIAS (NO INCLUIDAS EN KIT)
TUBO VERTICAL BAMBOO 5 cm. 150 (G 25)	Tubo cuadrado de 16x16 mm. mecanizado, con una altura de 1,500 metros.	Cortando 1,796 metros.	x5 + x1 [h: 26,5cm.] + x6
		Desde 1,836 metros.	x6 + x6
		Hasta 1,867 metros.	x6 + x1 [h: 3cm.] + x7
TUBO VERTICAL BAMBOO 5 cm. 180 (G 57)	Tubo cuadrado de 16x16 mm. mecanizado, con una altura de 1,805 metros.	Cortando 2,102 metros.	x6 + x1 [h: 26,5cm.] + x7
		Desde 2,142 metros.	x7 + x7
		Hasta 2,173 metros.	x7 + x1 [h: 3cm.] + x8
TUBO VERTICAL BAMBOO 5 cm. 211 (G 38)	Tubo cuadrado de 16x16 mm. mecanizado, con una altura de 2,115 metros.	Cortando 2,408 metros.	x7 + x1 [h: 26,5cm.] + x8
		Desde 2,448 metros.	x8 + x8
		Hasta 2,479 metros.	x8 + x1 [h: 3cm.] + x9
TUBO VERTICAL BAMBOO 5 cm. 242 (G 58)	Tubo cuadrado de 16x16 mm. mecanizado, con una altura de 2,425 metros.	Cortando 2,714 metros.	x8 + x1 [h: 26,5cm.] + x9
		Desde 2,754 metros.	x9 + x9
		Hasta 2,785 metros.	x9 + x1 [h: 3cm.] + x10
TUBO VERTICAL BAMBOO 5 cm. 273 (G 56)	Tubo cuadrado de 16x16 mm. mecanizado, con una altura de 2,730 metros.	Cortando 3,020 metros.	x9 + x1 [h: 26,5cm.] + x10
		Desde 3,060 metros.	x10 + x10
		Hasta 3,091 metros.	x10 + x1 [h: 3cm.] + x11

RELACIÓN ALTURA DE PIEZAS

CUBE 4,2 x 61 cm. **BAMBOO** 5 x 61 cm. 5x61 cm. = equivale a 2 = 5x30,5 cm. **BAMBOO** 5 x 30,5 cm.

DYNAMIC

EVOLUTION
EXTRUDED PORCELAIN TILE

PE GRES EXTR. PORCELÁNICO
PORCELAIN EXTRUDED TILE

REVESTIMIENTO
WALL TILE

SIN MANTENIMIENTO
NO MAINTENANCE

SUPERFICIE MATE
MATT SURFACE

RESIST. A LA HELADA
FROST PROOF

RESIST. A ÁCIDOS Y BASES
RESIST. TO ACIDS & BASES

FORMATOS:

7,5 x 30 - 3" x 12"
CUBIK 26 x 30 - 10,1" x 12"
ARCH 15 x 30 - 6" x 12"
ANGLE 12,5 x 30 - 5" x 12"
LANCE 10 x 30 - 3,9" x 12"
BLOCK 10 x 30 - 3,9" x 12"



DYNAMIC LANCE



DYNAMIC BLOCK



ESTE PRODUCTO PERMITE DIFERENTES COLOCACIONES:
THIS PRODUCT ALLOWS DIFFERENT PLACEMENTS:

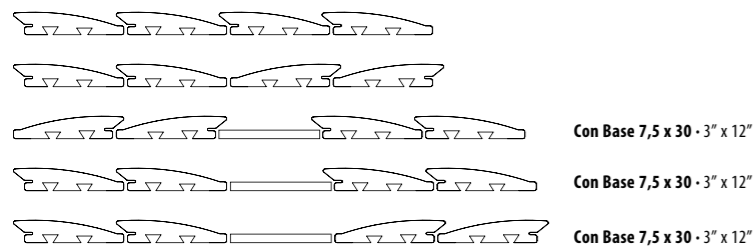

PERFIL PROFILE

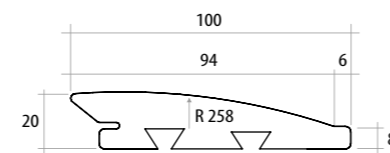

ESTE PRODUCTO PERMITE DIFERENTES COLOCACIONES:
THIS PRODUCT ALLOWS DIFFERENT PLACEMENTS:

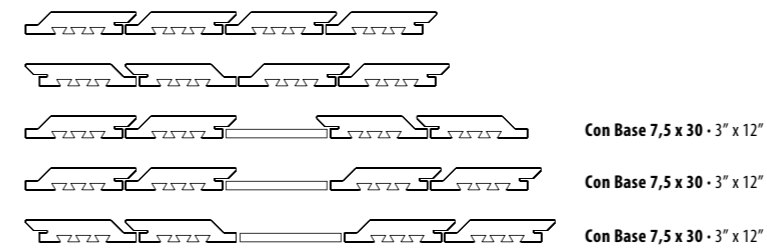

PERFIL PROFILE

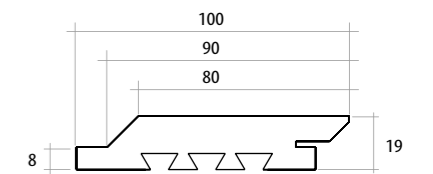

PACKING BASES

FORMATO	PULGADAS	PZ/CAJA	M ²	CAJA/PLT	PESO/CAJA	PESO/PLT
LANCE 10 x 30	3,9" x 12"	24	0,725	24	22,8	565

PACKING BASES

FORMATO	PULGADAS	PZ/CAJA	M ²	CAJA/PLT	PESO/CAJA	PESO/PLT
BLOCK 10 x 30	3,9" x 12"	24	0,725	24	21,5	530

DYNAMIC

EVOLUTION
EXTRUDED PORCELAIN TILE

PE GRES EXTR. PORCELÁNICO
PORCELAIN EXTRUDED TILE

REVESTIMIENTO
WALL TILE

SIN MANTENIMIENTO
NO MAINTENANCE

SUPERFICIE MATE
MATT SURFACE

RESIST. A LA HELADA
FROST PROOF

RESIST. A ÁCIDOS Y BASES
RESIST. TO ACIDS & BASES

FORMATOS:
7,5 x 30 - 3" x 12"
CUBIK 26 x 30 - 10,1" x 12"
ARCH 15 x 30 - 6" x 12"
ANGLE 12,5 x 30 - 5" x 12"
LANCE 10 x 30 - 3,9" x 12"
BLOCK 10 x 30 - 3,9" x 12"

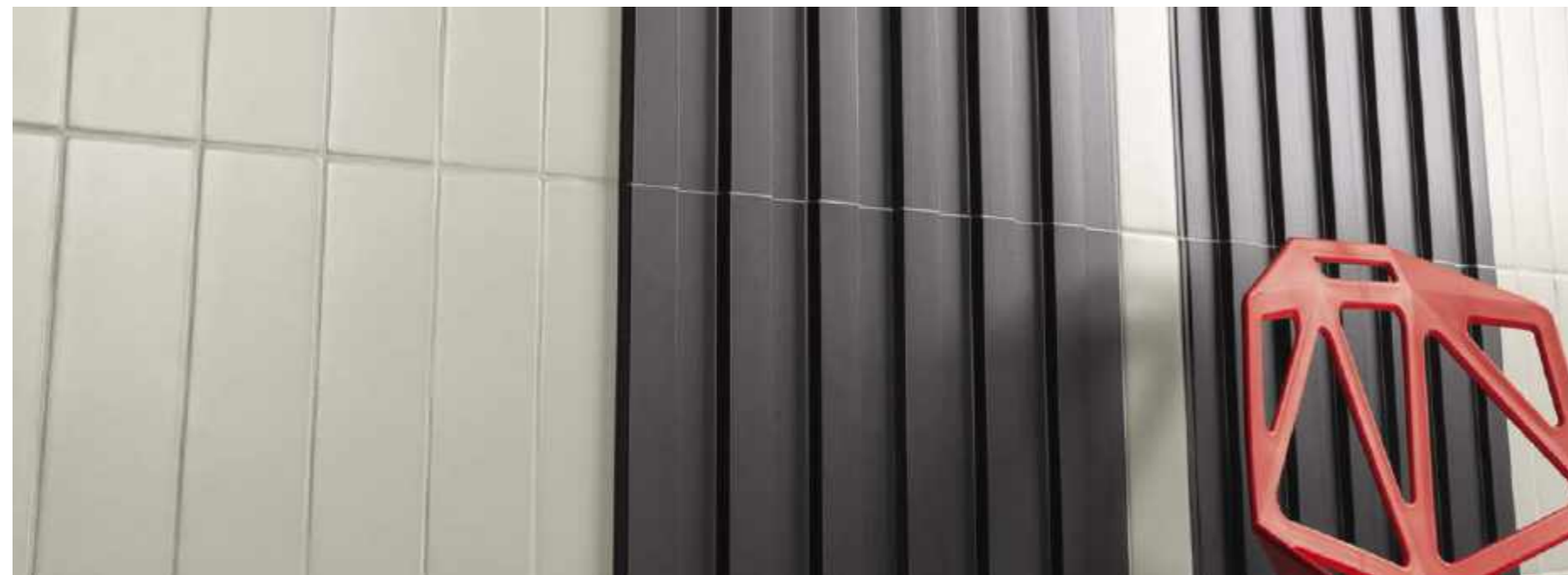

BASE LISA · SMOOTH BASE

BASES COMBINABLES SERIE ART
COMBINABLE BASES

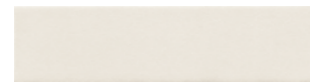

DYNAMIC WHITE
7,5 x 30 (G 59) 3" x 12" m

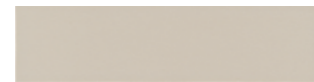

ART ROPE 10
7,5 x 30 (G 59) 3" x 12" m

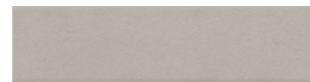

ART ALUMINIUM 10
7,5 x 30 (G 59) 3" x 12" m

DYNAMIC CUBIK



DYNAMIC CUBIK FROST
26 X 30 (G 65) 10,1" x 12" m



DYNAMIC CUBIK GRIZZLY
26 X 30 (G 65) 10,1" x 12" m



DYNAMIC CUBIK DARK
26 X 30 (G 65) 10,1" x 12" m



PERFIL PROFILE

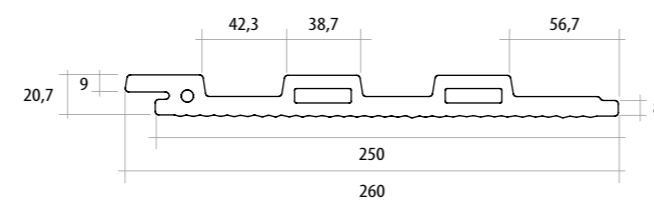

ESTE PRODUCTO PERMITE DIFERENTES COLOCACIONES:
THIS PRODUCT ALLOWS DIFFERENT PLACEMENTS:

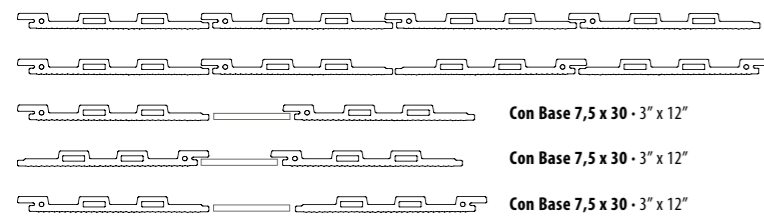

PACKING BASES

FORMATO	PULGADAS	PZ/CAJA	M ²	CAJA/PLT	PESO/CAJA	PESO/PLT
7,5 x 30	3" x 12"	22	0,5	120	8,11	990
CUBIK 26 x 30	10,1" x 12"	8	0,625	24	18,15	450

DYNAMIC ARCH



DYNAMIC ARCH FROST
15 x 30 (G 51) 6" x 12" m



DYNAMIC ARCH GRIZZLY
15 x 30 (G 51) 6" x 12" m



DYNAMIC ARCH DARK
15 x 30 (G 51) 6" x 12" m



PERFIL PROFILE

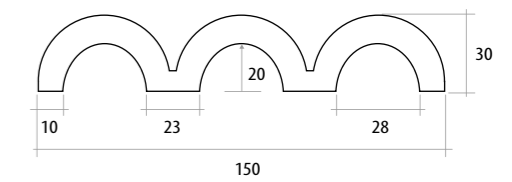

DYNAMIC ANGLE



DYNAMIC ANGLE FROST
12,5 x 30 (G 51) 5" x 12" m



DYNAMIC ANGLE GRIZZLY
12,5 x 30 (G 51) 5" x 12" m



DYNAMIC ANGLE DARK
12,5 x 30 (G 51) 5" x 12" m



PERFIL PROFILE

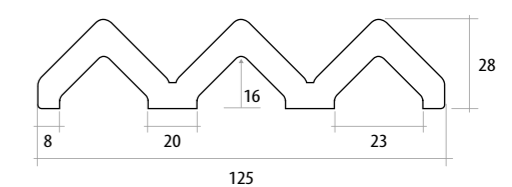

PACKING BASES

FORMATO	PULGADAS	PZ/CAJA	M ²	CAJA/PLT	PESO/CAJA	PESO/PLT
ARCH 15 x 30	6" x 12"	13	0,585	24	18,90	400

PACKING BASES

FORMATO	PULGADAS	PZ/CAJA	M ²	CAJA/PLT	PESO/CAJA	PESO/PLT
ANGLE 12,5 x 30	5" x 12"	20	0,75	24	23,1	570

www.natucer.es

PROYECTO: "REBIABLE"

Biorreactores de membrana sostenibles y competitivos para tratamientos

Objetivo: Promover el desarrollo tecnológico, la innovación y una investigación de calidad.



El proyecto, con nº de expediente RTC-2015-3485-5, ha sido cofinanciado por el Ministerio de Economía y Competitividad y el Fondo Europeo de Desarrollo regional (FEDER) en la convocatoria Retos-Colaboración del Programa Estatal de Investigación, Desarrollo e Innovación Orientada a los Retos de la Sociedad, en el marco del Plan Estatal de Investigación Científica y Técnica y de Innovación 2013-2016.

MADE IN SPAIN